



ATHENEUM COLLECTION
SPECIFICATION GUIDE & LIST PRICES

04.15.12

TUOHY

ATHENEUM COLLECTION

Design:
David Allan Pessa, New Studio

TYPICALS	34	PEDESTALS	49
DESK-TABLES	36	HUTCH72	50
DESKS, DOUBLE PEDESTAL	36	HUTCH85	52
DESKS, SINGLE PEDESTAL	38	HUTCH ACCESSORIES	54
DESKS W. BULLET TOP	39	WALL HUTCH	56
DESKS W. P TOP	39	FABRIC PANELS, WALL HUNG	57
RUNOFF24	40	TOWERS72	58
RUNOFF30	41	TOWERS85	59
RUNOFF36	43		
BRIDGE	45		
CREDENZAS	46		
CREDENZA TOPS	47		
BASE L/T/I PANELS	48		
MODESTY PANELS	48		

ATHENEUM TYPICALS

FREIGHT INCLUDED
APRIL 15, 2012

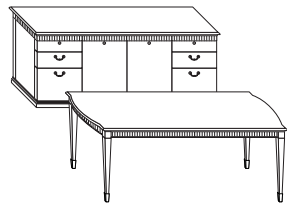

A1
DeskTable (4s): 72x36
Credenza (3s): 2BF-DbiCab-2BF

Product No.	List \$
69ABR30	5631
69CZR01	7281
Total	12912

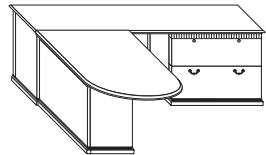

A2
Runoff36/Bullet: Panel-Base LH 60
Base-L24 (2s) Unfinished Back: LH 18
Ped24 (4s): 2LatF 36
CredenzaTop24 (3s): 90

69KGN10	3367
69MLA48	581
69MBF31	3016
69LAW36	1490
Total	8454

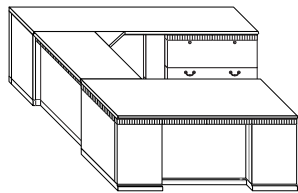

A3
Desk: 2BF-LBase 72x36
Bridge24: 48
Base-L24: LH 18
Ped24: 2LatF 36
CredenzaTop24: 90
Computer Corner Adaptor Top

69DAR50	5396
69GTJ00	2151
71MLA40	500
69MBF30	2603
69LAW30	1314
69LCA01	277
Total	12241

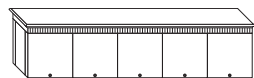

A4
DeskTable (4s): 72x36
Ped24 (4s): 2LatB-LatF 30
Ped24 (4s): 2LatB-LatF 30
CredenzaTop24 (3s): 90
Hutch (3s): Cabinet1 90

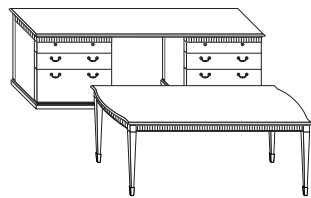

69ABR30	5631
69MAD31	2999
69MAD31	2999
69LAW36	1490
69QCW07	5016
Total	18135

PRIVATE OFFICE: ATHENEUM



Specify: Product No. Hardware Finish: For quarter-sawn borders, specify
Quantity 712 Satin Black Option BA, add 50%.
Tagging 713 Low Lustre Brass
Wood Finish 715 Brushed Nickel



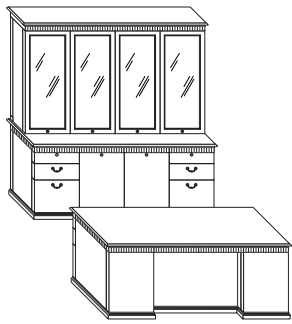

A5
Desk (4s): 2BF-2BF 72x36
Credenza (3s): 2BF-DbiCab-2BF
Hutch72 (3s): GlassDrs3 72

Product No.	List \$
69BBR30	7983
69CZR01	7281
69PKR07	8774
Total	24038

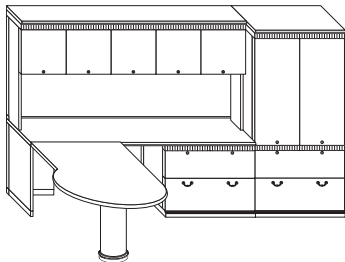

A6
Runoff36/P: Cylinder LH 66
Base-L24: LH 18
Ped24: 2LatF 36
CredenzaTop24: 90
Hutch72: Cabinet1/Fab 90
Tower 72/24: Cab/LatF 36

69KHP13	4215
71MLA40	500
69MBF30	2603
69LAW30	1314
69PCW30	5452
69TEF30	6345
Total	20429

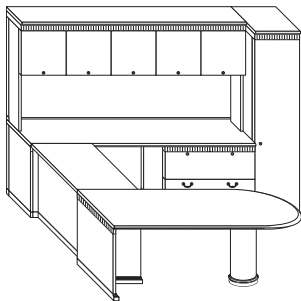

A7
Desk/Bullet: Cylinder-TBase 78x36
Bridge24: 48
Base-L24: LH 18
Ped24: 2LatF 36
CredenzaTop24: 90
Hutch72: Cabinet1/Fab 90
Tower 72/24: Garment RH 18

69EET33	4195
69GTJ00	2151
71MLA40	500
69MBF30	2603
69LAW30	1314
69PCW30	5452
69TCA50	3349
Total	19564

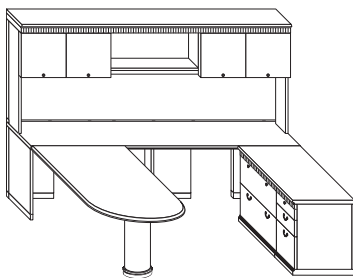

A8
Runoff36/Bullet: Cylinder 60
Base-L24: LH 18
Base-T9: 36
Base-L24: RH 18
CredenzaTop24: 108
Hutch72: Cab1-Shlv1-Cab1/Fab 108
Runoff24 Top-Only: RH 54
Ped24: 2BF 18
Ped24: 2LatF 36

69KGN03	3374
71MLA40	500
71MMF30	721
71MLA50	500
69LAY30	1585
69PFY30	5673
69GTL20	1482
69MAA30	2039
69MBF30	2603
Total	18477



Specify: Product No. Hardware Finish: For quarter-sawn borders, specify
Quantity 712 Satin Black Option BA, add 50%.
Tagging 713 Low Lustre Brass
Wood Finish 715 Brushed Nickel



Product No. List \$

Desk-Tables

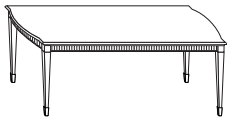

	w	d	29.9h	Detail All Sides	
Includes Lap Drawer					
DeskTable (4s): 76x30	77.6	31.7		69ABR00	5531
• DeskTable (4s): 78x36	79.2	37.7		69ABR30	5631
DeskTable (4s): 84x36	85.2	37.7		69ABT30	5839

Desks, Double Pedestal

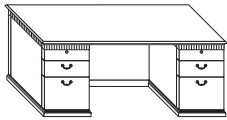

	w	d	29.9h	Detail All Sides	
2BF-2BF -					
Desk (4s): 2BF-2BF 66x30	67.7	31.7		69BBP00	7729
Desk (4s): 2BF-2BF 72x30	73.7	31.7		69BBR00	7796
• Desk (4s): 2BF-2BF 72x36	73.7	37.7		69BBR30	7983
Desk (4s): 2BF-2BF 78x36	79.7	37.7		69BBT30	8208

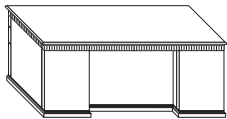

Visitor's Side

	w	d	29.9h	Detail All Sides	
2F-2BF -					
Desk (4s): 2F-2BF 66x30	67.7	31.7		69BBP01	7729
Desk (4s): 2F-2BF 72x30	73.7	31.7		69BBR01	7796
Desk (4s): 2F-2BF 72x36	73.7	37.7		69BBR31	7983
Desk (4s): 2F-2BF 78x36	79.7	37.7		69BBT31	8208

	w	d	29.9h	Detail All Sides	
2BF-2F -					
Desk (4s): 2BF-2F 66x30	67.7	31.7		69BBP02	7729
Desk (4s): 2BF-2F 72x30	73.7	31.7		69BBR02	7796
Desk (4s): 2BF-2F 72x36	73.7	37.7		69BBR32	7983
Desk (4s): 2BF-2F 78x36	79.7	37.7		69BBT32	8208

	w	d	29.9h	Detail All Sides	
2F-2F -					
Desk (4s): 2F-2F 66x30	67.7	31.7		69BBP03	7729
Desk (4s): 2F-2F 72x30	73.7	31.7		69BBR03	7796
Desk (4s): 2F-2F 72x36	73.7	37.7		69BBR33	7983
Desk (4s): 2F-2F 78x36	79.7	37.7		69BBT33	8208

Options

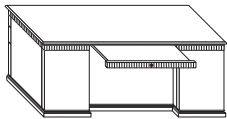
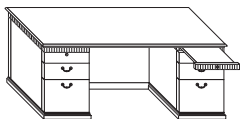

Visitor's Side

DeskPull-OutShelves:					
Desk Shelf, User LH, Non-handed, or modular pedestals				Option SL	613
Desk Shelf, User LH & RH				Option SB	1230
• Desk Shelf, User RH				Option SR	613
• Desk Shelf, Visitor Knee Only				Option SK	750
Desk Shelf, Visitor +User LH				Option SC	1365
Desk Shelf, Visitor +User LH & RH				Option SD	1982
Desk Shelf, Visitor +User RH				Option SA	1365

! Important: A Desk Shelf cannot be used on the visitor's side when a pencil lap drawer is used, or when Transaction Tops or Oversized Tops are used. User-side Desk-Shelf units may only be used on a 2-Box/File pedestal.

Quarter-Sawn Borders
(Available on all Atheneum casegoods and tables)

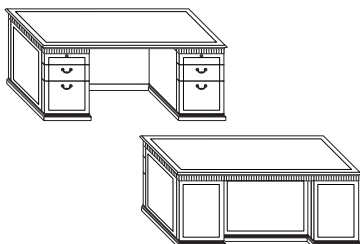

Borders: All Outer Surfaces* Option BA 50%

* Outer surfaces are defined to be:
Worksurfaces and upgraded finished tops for hutches or towers.
Vertical surfaces below the worksurface that have toeboards and are NOT in a kneespace area.
Vertical surfaces above the worksurface that have top edge detailing.



Specify:	Product No.	Hardware Finish:	For quarter-sawn borders, specify
	Quantity	712 Satin Black	Option BA, add 50%.
	Tagging	713 Low Lustre Brass	
	Wood Finish	715 Brushed Nickel	• Denotes Item is illustrated..
			- Includes locks.



Product No. List \$

Desks, Double Ped w/ Oversized Top

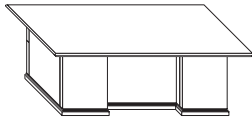

Visitor's Side

Overhang—Three Sides -	w	d	29.9h	Detail All Sides	
Desk/Oversized: 2BF-2BF 72x36	79.7	43.7		69BEP00	8199
Desk/Oversized: 2BF-2F 72x36	79.7	43.7		69BEP02	8199
Desk/Oversized: 2F-2BF 72x36	79.7	43.7		69BEP01	8199
Desk/Oversized: 2F-2F 72x36	79.7	43.7		69BEP03	8199

Note: Do not use a Desk Shelf on the visitor's side with these units.

Desks, Dbl Ped w/ Transaction Front

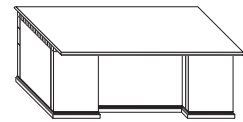
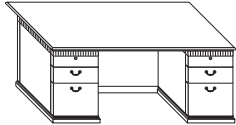

Visitor's Side

2BF-2BF -	w	d	29.9h	Detail All Sides	
Desk/Trans: 2BF-2BF 66x30	67.7	37.7		69BHP00	7900
Desk/Trans: 2BF-2BF 72x30	73.7	37.7		69BHR00	8023
• Desk/Trans: 2BF-2BF 72x36	73.7	43.7		69BHR30	8107
Desk/Trans: 2BF-2BF 78x36	79.7	43.7		69BHT30	8315

2F-2BF -	w	d	29.9h	Detail All Sides	
Desk/Trans: 2F-2BF 66x30	67.7	37.7		69BHP01	7900
Desk/Trans: 2F-2BF 72x30	73.7	37.7		69BHR01	8023
Desk/Trans: 2F-2BF 72x36	73.7	43.7		69BHR31	8107
Desk/Trans: 2F-2BF 78x36	79.7	43.7		69BHT31	8315

2BF-2F -	w	d	29.9h	Detail All Sides	
Desk/Trans: 2BF-2F 66x30	67.7	37.7		69BHP02	7900
Desk/Trans: 2BF-2F 72x30	73.7	37.7		69BHR02	8023
Desk/Trans: 2BF-2F 72x36	73.7	43.7		69BHR32	8107
Desk/Trans: 2BF-2F 78x36	79.7	43.7		69BHT32	8315

2F-2F -	w	d	29.9h	Detail All Sides	
Desk/Trans: 2F-2F 66x30	67.7	37.7		69BHP03	7900
Desk/Trans: 2F-2F 72x30	73.7	37.7		69BHR03	8023
Desk/Trans: 2F-2F 72x36	73.7	43.7		69BHR33	8107
Desk/Trans: 2F-2F 78x36	79.7	43.7		69BHT33	8315

Note: Do not use a Desk Shelf on the visitor's side with these units.



Specify: Product No. Hardware Finish: For quarter-sawn borders, specify
Quantity 712 Satin Black Option BA, add 50%.
Tagging 713 Low Lustre Brass • Denotes Item is illustrated.
Wood Finish 715 Brushed Nickel - Includes locks.



Desks, Single Pedestal

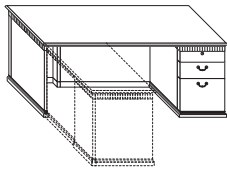

	w	d	29.9h	Flush Ends	Product No.	List \$	Product No.	List \$
2BF ↵								
Desk: LBase-2BF 66x30	66	31.7			69DAP10	5097	69DBP10	6080
Desk: LBase-2BF 72x30	72	31.7			69DAR10	5290	69DBR10	6217
• Desk: LBase-2BF 72x36	72	37.7			69DAR40	5396	• 69DBR40	6338
Desk: LBase-2BF 78x36	78	37.7			69DAT40	5684	69DBT40	6607
Desk: 2BF-LBase 66x30	66	31.7			69DAP20	5097	69DBP20	6080
Desk: 2BF-LBase 72x30	72	31.7			69DAR20	5290	69DBR20	6217
Desk: 2BF-LBase 72x36	72	37.7			69DAR50	5396	69DBR50	6338
Desk: 2BF-LBase 78x36	78	37.7			69DAT50	5684	69DBT50	6607

	w	d	29.9h	Flush Ends	Product No.	List \$	Product No.	List \$
2F ↵								
Desk: LBase-2F 66x30	66	31.7			69DAP11	5097	69DBP11	6080
Desk: LBase-2F 72x30	72	31.7			69DAR11	5290	69DBR11	6217
Desk: LBase-2F 72x36	72	37.7			69DAR41	5396	69DBR41	6338
Desk: LBase-2F 78x36	78	37.7			69DAT41	5684	69DBT41	6607
Desk: 2F-LBase 66x30	66	31.7			69DAP21	5097	69DBP21	6080
Desk: 2F-LBase 72x30	72	31.7			69DAR21	5290	69DBR21	6217
Desk: 2F-LBase 72x36	72	37.7			69DAR51	5396	69DBR51	6338
Desk: 2F-LBase 78x36	78	37.7			69DAT51	5684	69DBT51	6607

Desks, Sgl Ped w/ Transaction Front

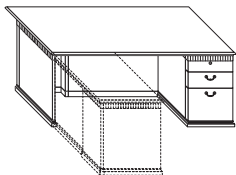

	w	d	29.9h	Flush Ends	Product No.	List \$	Product No.	List \$
2BF ↵								
Desk/Trans: LBase-2BF 66x30	66	37.7			69DGP18	5312	69DHP18	6294
Desk/Trans: LBase-2BF 72x30	72	37.7			69DGR18	5600	69DHR18	6532
• Desk/Trans: LBase-2BF 72x36	72	43.7			69DGR48	5715	• 69DHR48	6660
Desk/Trans: LBase-2BF 78x36	78	43.7			69DGT48	5999	69DHT48	6919
Desk/Trans: 2BF-LBase 66x30	66	37.7			69DGP28	5312	69DHP28	6294
Desk/Trans: 2BF-LBase 72x30	72	37.7			69DGR28	5600	69DHR28	6532
Desk/Trans: 2BF-LBase 72x36	72	43.7			69DGR58	5715	69DHR58	6660
Desk/Trans: 2BF-LBase 78x36	78	43.7			69DGT58	5999	69DHT58	6919

	w	d	29.9h	Flush Ends	Product No.	List \$	Product No.	List \$
2F ↵								
Desk/Trans: LBase-2F 66x30	66	37.7			69DGP19	5312	69DHP19	6294
Desk/Trans: LBase-2F 72x30	72	37.7			69DGR19	5600	69DHR19	6532
Desk/Trans: LBase-2F 72x36	72	43.7			69DGR49	5715	69DHR49	6660
Desk/Trans: LBase-2F 78x36	78	43.7			69DGT49	5999	69DHT49	6919
Desk/Trans: 2F-LBase 66x30	66	37.7			69DGP29	5312	69DHP29	6294
Desk/Trans: 2F-LBase 72x30	72	37.7			69DGR29	5600	69DHR29	6532
Desk/Trans: 2F-LBase 72x36	72	43.7			69DGR59	5715	69DHR59	6660
Desk/Trans: 2F-LBase 78x36	78	43.7			69DGT59	5999	69DHT59	6919

§ Add 1.7 to width



Specify: Product No. Hardware Finish: For quarter-sawn borders, specify
 Quantity 712 Satin Black Option BA, add 50%.
 Tagging 713 Low Lustre Brass • Denotes Item is illustrated..
 Wood Finish 715 Brushed Nickel ↵ Includes locks.



Desks w. Bullet Top

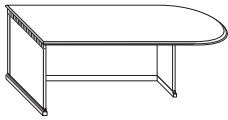
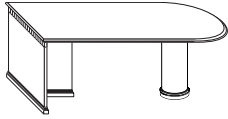
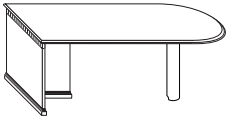

User's Side

Desks w. P Top

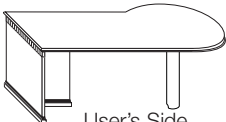

User's Side

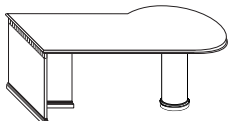

User's Side

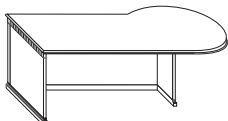

User's Side

Product No. List \$ Product No. List \$

Post-Leg & T-Base ‡	w	d	29.9h	Flush End	\$ Detail All Sides	
Desk/Bullet: Post-TBase 66x30	66.9	31.7		69EEP01	4170	69EFP01 4387
Desk/Bullet: Post-TBase 72x30	72.9	31.7		69EER01	4199	69EFR01 4414
• Desk/Bullet: Post-TBase 72x36	72.9	37.7		69EER31	4244	• 69EFR31 4469
Desk/Bullet: Post-TBase 78x36	78.9	37.7		69EET31	4469	69EFT31 4713

Atheneum Post-Legs are Black resin-coated steel, with wire management.

Cylinder & T-Base ‡	w	d	29.9h	Flush End	\$ Detail All Sides	
Desk/Bullet: Cylinder-TBase 66x30	66.9	31.7		69EEP03	4599	69EFP03 4815
Desk/Bullet: Cylinder-TBase 72x30	72.9	31.7		69EER03	4628	69EFR03 4848
• Desk/Bullet: Cylinder-TBase 72x36	72.9	37.7		69EER33	4677	• 69EFR33 4901
Desk/Bullet: Cylinder-TBase 78x36	78.9	37.7		69EET33	4911	69EFT33 5148

Continuous Panel-Base ‡	w	d	29.9h	Flush End	\$ Detail All Sides	
Desk/Bullet: Panel-Base LH 66x30	66.9	31.7		69EGP10	4258	69EHP10 4546
Desk/Bullet: Panel-Base LH 72x30	72.9	31.7		69EGR10	4331	69EHR10 4586
• Desk/Bullet: Panel-Base LH 72x36	72.9	37.7		69EGR40	4379	• 69EHR40 4831
Desk/Bullet: Panel-Base LH 78x36	78.9	37.7		69EGT40	4610	69EHT40 4882
Desk/Bullet: Panel-Base RH 66x30	66.9	31.7		69EGP20	4258	69EHP20 4546
Desk/Bullet: Panel-Base RH 72x30	72.9	31.7		69EGR20	4331	69EHR20 4586
Desk/Bullet: Panel-Base RH 72x36	72.9	37.7		69EGR50	4379	69EHR50 4831
Desk/Bullet: Panel-Base RH 78x36	78.9	37.7		69EGT50	4610	69EHT50 4882

§ Add 0.9 to width

Post-Leg & T-Base ‡	w	d	29.9h	Flush End	\$ Detail All Sides	
Desk/P: TBase-Post 66x30	66.9	37.7		69ENP11	5024	69EOP11 5241
Desk/P: TBase-Post 72x30	72.9	37.7		69ENR11	5053	69EOR11 5274
• Desk/P: TBase-Post 72x36	72.9	43.7		69ENR41	5102	• 69EOR41 5326
Desk/P: TBase-Post 78x36	78.9	43.7		69ENT41	5335	69EOT41 5573
Desk/P: Post-TBase 66x30	66.9	37.7		69ENP21	5024	69EOP21 5241
Desk/P: Post-TBase 72x30	72.9	37.7		69ENR21	5053	69EOR21 5274
Desk/P: Post-TBase 72x36	72.9	43.7		69ENR51	5102	69EOR51 5326
Desk/P: Post-TBase 78x36	78.9	43.7		69ENT51	5335	69EOT51 5573

Atheneum Post-Legs are Black resin-coated steel, with wire management.

Cylinder & T-Base ‡	w	d	29.9h	Flush End	\$ Detail All Sides	
Desk/P: TBase-Cylinder 66x30	66.9	37.7		69ENP13	5241	69EOP13 5452
Desk/P: TBase-Cylinder 72x30	72.9	37.7		69ENR13	5267	69EOR13 5486
• Desk/P: TBase-Cylinder 72x36	72.9	43.7		69ENR43	5316	• 69EOR43 5538
Desk/P: TBase-Cylinder 78x36	78.9	43.7		69ENT43	5548	69EOT43 5786
Desk/P: Cylinder-TBase 66x30	66.9	37.7		69ENP23	5241	69EOP23 5452
Desk/P: Cylinder-TBase 72x30	72.9	37.7		69ENR23	5267	69EOR23 5486
Desk/P: Cylinder-TBase 72x36	72.9	43.7		69ENR53	5316	69EOR53 5538
Desk/P: Cylinder-TBase 78x36	78.9	43.7		69ENT53	5548	69EOT53 5786

Continuous Panel-Base ‡	w	d	29.9h	Flush End	\$ Detail All Sides	
Desk/P: Panel-Base LH 66x30	66.9	37.7		69EQP10	4942	69ERP10 5154
Desk/P: Panel-Base LH 72x30	72.9	37.7		69EQR10	4964	69ERR10 5184
• Desk/P: Panel-Base LH 72x36	72.9	43.7		69EQR40	5005	• 69ERR40 5228
Desk/P: Panel-Base LH 78x36	78.9	43.7		69EQT40	5230	69ERT40 5469
Desk/P: Panel-Base RH 66x30	66.9	37.7		69EQP20	4942	69ERP20 5154
Desk/P: Panel-Base RH 72x30	72.9	37.7		69EQR20	4964	69ERR20 5184
Desk/P: Panel-Base RH 72x36	72.9	43.7		69EQR50	5005	69ERR50 5228
Desk/P: Panel-Base RH 78x36	78.9	43.7		69EQT50	5230	69ERT50 5469

§ Add 0.9 to depth

Specify: Product No.
Quantity
Tagging
Wood Finish

For quarter-sawn borders, specify
Option BA, add 50%.

• Denotes Item is illustrated.
‡ Requires field sub-assembly.



Runoff24: Rectangular

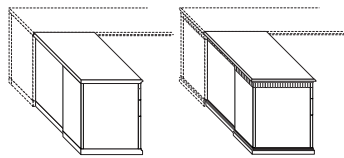

Flush End/Back Detail All Sides

	w	24.9d	29.9h	Flush End/Back	§	Detail All Sides
2BF ↯						
Runoff24: 2BF LH 42	41.1			69FRH10	3701	69FSH10 4396
Runoff24: 2BF LH 48	47.1			69FRJ10	3771	69FSJ10 4630
• Runoff24: 2BF LH 54	53.1			69FRL10	3911	69FSL10 4861
Runoff24: 2BF RH 42	41.1			69FRH20	3701	69FSH20 4396
Runoff24: 2BF RH 48	47.1			69FRJ20	3771	69FSJ20 4630
Runoff24: 2BF RH 54	53.1			69FRL20	3911	69FSL20 4861

	w	24.9d	29.9h	Flush End/Back	§	Detail All Sides
2F ↯						
Runoff24: 2F LH 42	41.1			69FRH11	3701	69FSH11 4396
Runoff24: 2F LH 48	47.1			69FRJ11	3771	69FSJ11 4630
Runoff24: 2F LH 54	53.1			69FRL11	3911	69FSL11 4861
Runoff24: 2F RH 42	41.1			69FRH21	3701	69FSH21 4396
Runoff24: 2F RH 48	47.1			69FRJ21	3771	69FSJ21 4630
Runoff24: 2F RH 54	53.1			69FRL21	3911	69FSL21 4861

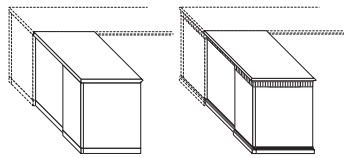

Flush End/Back Detail All Sides

	w	24.9d	29.9h	Flush End/Back	§	Detail All Sides
L-Base						
Runoff24: LBase LH 42	41.1			69GRH10	2105	69GSH10 2463
Runoff24: LBase LH 48	47.1			69GRJ10	2156	69GSJ10 2547
• Runoff24: LBase LH 54	53.1			69GRL10	2231	69GSL10 2656
Runoff24: LBase LH 84	83.1			69GRV10	2683	69GSV10 3146
Runoff24: LBase RH 42	41.1			69GRH20	2105	69GSH20 2463
Runoff24: LBase RH 48	47.1			69GRJ20	2156	69GSJ20 2547
Runoff24: LBase RH 54	53.1			69GRL20	2231	69GSL20 2656
Runoff24: LBase RH 84	83.1			69GRV20	2683	69GSV20 3146

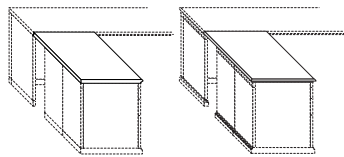

Flush End/Back Detail All Sides

	w	24.9d	1.5th	Flush End/Back	§	Detail All Sides
Top-Only (29.9h)						
Runoff24 Top-Only: LH 42	41.1			69GTH10	1269	69GUH00 1450
Runoff24 Top-Only: LH 48	47.1			69GTJ10	1341	69GUJ00 1648
• Runoff24 Top-Only: LH 54	53.1			69GTL10	1482	69GUL00 1842
Runoff24 Top-Only: LH 60	59.6			69GTN10	1506	69GUN00 1869
Runoff24 Top-Only: LH 72	71.1			69GTR10	1549	69GUR00 1924
Runoff24 Top-Only: LH 84	83.1			69GTV10	1960	69GUV00 2415
Runoff24 Top-Only: RH 42	41.1			69GTH20	1269	Non-handed
Runoff24 Top-Only: RH 48	47.1			69GTJ20	1341	Non-handed
Runoff24 Top-Only: RH 54	53.1			69GTL20	1482	Non-handed
Runoff24 Top-Only: RH 60	59.6			69GTN20	1506	Non-handed
Runoff24 Top-Only: RH 72	71.1			69GTR20	1549	Non-handed
Runoff24 Top-Only: RH 84	83.1			69GTV20	1960	Non-handed

§ Add 0.9 to w, d



Specify: Product No. Hardware Finish: For quarter-sawn borders, specify
 Quantity 712 Satin Black Option BA, add 50%.
 Tagging 713 Low Lustre Brass
 Wood Finish 715 Brushed Nickel
 • Denotes Item is illustrated.
 ↯ Includes locks.
 ‡ Requires field sub-assembly.



Runoff30: Rectangular

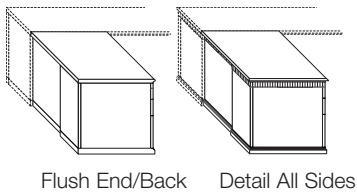

2BF ↯	w	30.9d	29.9h	Flush End/Back	§	Detail All Sides
• Runoff30: 2BF LH 48	47.1			69HAJ10	4285	69HBJ10 4958
Runoff30: 2BF LH 54	53.1			69HAL10	4388	69HBL10 5097
Runoff30: 2BF LH 60	59.1			69HAN10	4477	69HBN10 5190
Runoff30: 2BF LH 66	65.1			69HAP10	4585	69HBP10 5328
Runoff30: 2BF LH 72	71.1			69HAR10	4670	69HBR10 5452
Runoff30: 2BF RH 48	47.1			69HAJ20	4285	69HBJ20 4958
Runoff30: 2BF RH 54	53.1			69HAL20	4388	69HBL20 5097
Runoff30: 2BF RH 60	59.1			69HAN20	4477	69HBN20 5190
Runoff30: 2BF RH 66	65.1			69HAP20	4585	69HBP20 5328
Runoff30: 2BF RH 72	71.1			69HAR20	4670	69HBR20 5452

2F ↯	w	30.9d	29.9h	Flush End/Back	§	Detail All Sides
Runoff30: 2F LH 48	47.1			69HAJ12	4285	69HBJ12 4958
Runoff30: 2F LH 54	53.1			69HAL12	4388	69HBL12 5097
Runoff30: 2F LH 60	59.1			69HAN12	4477	69HBN12 5190
Runoff30: 2F LH 66	65.1			69HAP12	4585	69HBP12 5328
Runoff30: 2F LH 72	71.1			69HAR12	4670	69HBR12 5452
Runoff30: 2F RH 48	47.1			69HAJ22	4285	69HBJ22 4958
Runoff30: 2F RH 54	53.1			69HAL22	4388	69HBL22 5097
Runoff30: 2F RH 60	59.1			69HAN22	4477	69HBN22 5190
Runoff30: 2F RH 66	65.1			69HAP22	4585	69HBP22 5328
Runoff30: 2F RH 72	71.1			69HAR22	4670	69HBR22 5452

§ Add 0.9 to w, d



Specify: Product No. Hardware Finish: For quarter-sawn borders, specify
 Quantity 712 Satin Black Option BA, add 50%.
 Tagging 713 Low Lustre Brass
 Wood Finish 715 Brushed Nickel

- Denotes Item is illustrated.
- ↯ Includes locks.
- ‡ Requires field sub-assembly.

Product No. List \$

Runoff30: Bullet-Shape

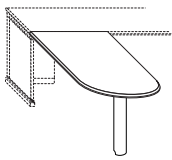

Post-Leg ‡	w	31.7d 29.9h	Detail All Sides	
Runoff30/Bullet: Post-Leg 48	48		69KEJ01	2930
• Runoff30/Bullet: Post-Leg 54	54		69KEL01	3045
Runoff30/Bullet: Post-Leg 60	60		69KEN01	3161
Runoff30/Bullet: Post-Leg 66	66		69KEP01	3262
Runoff30/Bullet: Post-Leg 72	72		69KER01	3327

Atheneum Post-Legs are Black resin-coated steel, with wire management.

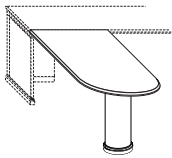

Cylinder Base ‡	w	31.7d 29.9h	Detail All Sides	
Runoff30/Bullet: Cylinder 48	48		69KEJ03	3146
• Runoff30/Bullet: Cylinder 54	54		69KEL03	3258
Runoff30/Bullet: Cylinder 60	60		69KEN03	3374
Runoff30/Bullet: Cylinder 66	66		69KEP03	3476
Runoff30/Bullet: Cylinder 72	72		69KER03	3538

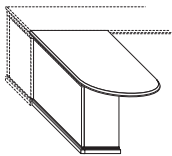

Panel-Base ‡	w	31.7d 29.9h	Detail All Sides	
Runoff30/Bullet: Panel-Base LH 48	48		69KEJ10	3002
• Runoff30/Bullet: Panel-Base LH 54	54		69KEL10	3152
Runoff30/Bullet: Panel-Base LH 60	60		69KEN10	3282
Runoff30/Bullet: Panel-Base LH 66	66		69KEP10	3411
Runoff30/Bullet: Panel-Base LH 72	72		69KER10	3489
Runoff30/Bullet: Panel-Base RH 48	48		69KEJ20	3002
Runoff30/Bullet: Panel-Base RH 54	54		69KEL20	3152
Runoff30/Bullet: Panel-Base RH 60	60		69KEN20	3282
Runoff30/Bullet: Panel-Base RH 66	66		69KEP20	3411
Runoff30/Bullet: Panel-Base RH 72	72		69KER20	3489

Panel-Base units must butt to a panel with toeboard detailing.

Runoff30: P-Shape

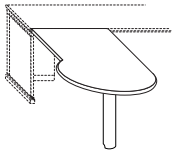

Post-Leg ‡	w	37.7d 29.9h	Detail All Sides	
• Runoff30/P: Post-Leg LH 66	66		69KFP11	3904
Runoff30/P: Post-Leg LH 72	72		69KFR11	3966
Runoff30/P: Post-Leg RH 66	66		69KFP21	3904
Runoff30/P: Post-Leg RH 72	72		69KFR21	3966

Atheneum Post-Legs are Black resin-coated steel, with wire management.

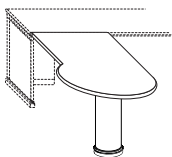

Cylinder Base ‡	w	37.7d 29.9h	Detail All Sides	
• Runoff30/P: Cylinder LH 66	66		69KFP13	4114
Runoff30/P: Cylinder LH 72	72		69KFR13	4180
Runoff30/P: Cylinder RH 66	66		69KFP23	4114
Runoff30/P: Cylinder RH 72	72		69KFR23	4180

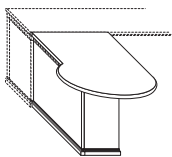

Panel-Base ‡	w	37.7d 29.9h	Detail All Sides	
• Runoff30/P: Panel-Base LH 66	66		69KFP10	4050
Runoff30/P: Panel-Base LH 72	72		69KFR10	4129
Runoff30/P: Panel-Base RH 66	66		69KFP20	4050
Runoff30/P: Panel-Base RH 72	72		69KFR20	4129

Specify: Product No.
Quantity
Tagging
Wood Finish

For quarter-sawn borders, specify
Option BA, add 50%.

- Denotes Item is illustrated.
- Includes locks.
- ‡ Requires field sub-assembly.



PRIVATE OFFICE: ATHENEUM

Runoff36: Rectangular

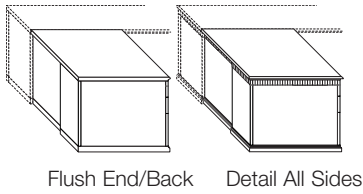

2BF ↯	w	36.9d	29.9h	Flush End/Back	§	Detail All Sides
Runoff36: 2BF LH 48	47.1			69JAJ10	4569	69JBJ10 5244
• Runoff36: 2BF LH 54	53.1			69JAL10	4705	69JBL10 5416
Runoff36: 2BF LH 60	59.1			69JAN10	4832	69JBN10 5544
Runoff36: 2BF LH 66	65.1			69JAP10	4973	69JBP10 5719
Runoff36: 2BF LH 72	71.1			69JAR10	5097	69JBR10 5877
Runoff36: 2BF RH 48	47.1			69JAJ20	4569	69JBJ20 5244
Runoff36: 2BF RH 54	53.1			69JAL20	4705	69JBL20 5416
Runoff36: 2BF RH 60	59.1			69JAN20	4832	69JBN20 5544
Runoff36: 2BF RH 66	65.1			69JAP20	4973	69JBP20 5719
Runoff36: 2BF RH 72	71.1			69JAR20	5097	69JBR20 5877

2F ↯				Flush End/Back	§	Detail All Sides
Runoff36: 2F LH 48	47.1			69JAJ12	4569	69JBJ12 5244
Runoff36: 2F LH 54	53.1			69JAL12	4705	69JBL12 5416
Runoff36: 2F LH 60	59.1			69JAN12	4832	69JBN12 5544
Runoff36: 2F LH 66	65.1			69JAP12	4973	69JBP12 5719
Runoff36: 2F LH 72	71.1			69JAR12	5097	69JBR12 5877
Runoff36: 2F RH 48	47.1			69JAJ22	4569	69JBJ22 5244
Runoff36: 2F RH 54	53.1			69JAL22	4705	69JBL22 5416
Runoff36: 2F RH 60	59.1			69JAN22	4832	69JBN22 5544
Runoff36: 2F RH 66	65.1			69JAP22	4973	69JBP22 5719
Runoff36: 2F RH 72	71.1			69JAR22	5097	69JBR22 5877

§ Add 0.9 to w, d



Specify: Product No. Hardware Finish: For quarter-sawn borders, specify
Quantity 712 Satin Black Option BA, add 50%.
Tagging 713 Low Lustre Brass
Wood Finish 715 Brushed Nickel

- Denotes Item is illustrated.
- ↯ Includes locks.
- ‡ Requires field sub-assembly.

Product No. List \$

Runoff36: Bullet-Shape

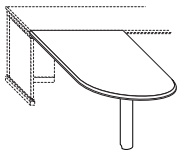

Post-Leg ‡	w	37.7d	29.9h	Detail All Sides	
Runoff36/Bullet: Post-Leg 48	48			69KGJ01	2986
Runoff36/Bullet: Post-Leg 54	54			69KGL01	3116
• Runoff36/Bullet: Post-Leg 60	60			69KGN01	3249
Runoff36/Bullet: Post-Leg 66	66			69KGP01	3362
Runoff36/Bullet: Post-Leg 72	72			69KGR01	3440

Atheneum Post-Legs are Black resin-coated steel, with wire management.

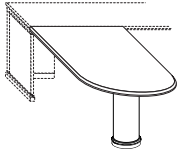

Cylinder ‡	w	37.7d	29.9h	Detail All Sides	
Runoff36/Bullet: Cylinder 48	48			69KGJ03	3203
Runoff36/Bullet: Cylinder 54	54			69KGL03	3329
• Runoff36/Bullet: Cylinder 60	60			69KGN03	3460
Runoff36/Bullet: Cylinder 66	66			69KGP03	3578
Runoff36/Bullet: Cylinder 72	72			69KGR03	3651

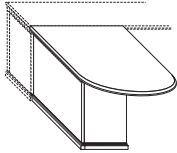

Panel-Base ‡	w	37.7d	29.9h	Detail All Sides	
Runoff36/Bullet: Panel-Base LH 48	48			69KGJ10	3060
Runoff36/Bullet: Panel-Base LH 54	54			69KGL10	3223
• Runoff36/Bullet: Panel-Base LH 60	60			69KGN10	3366
Runoff36/Bullet: Panel-Base LH 66	66			69KGP10	3509
Runoff36/Bullet: Panel-Base LH 72	72			69KGR10	3604
Runoff36/Bullet: Panel-Base RH 48	48			69KGJ20	3060
Runoff36/Bullet: Panel-Base RH 54	54			69KGL20	3223
Runoff36/Bullet: Panel-Base RH 60	60			69KGN20	3366
Runoff36/Bullet: Panel-Base RH 66	66			69KGP20	3509
Runoff36/Bullet: Panel-Base RH 72	72			69KGR20	3604

Panel-Base units must butt to a panel with toeboard detailing.

Runoff36: P-Shape

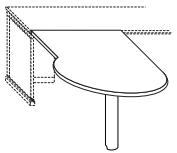

Post-Leg ‡	w	43.7d	29.9h		
• Runoff36/P: Post-Leg LH 66	66			69KHP11	4004
Runoff36/P: Post-Leg LH 72	72			69KHR11	4079
Runoff36/P: Post-Leg RH 66	66			69KHP21	4004
Runoff36/P: Post-Leg RH 72	72			69KHR21	4079

Atheneum Post-Legs are Black resin-coated steel, with wire management.

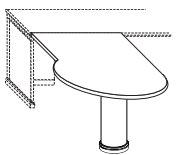

Cylinder ‡	w	43.7d	29.9h		
• Runoff36/P: Cylinder LH 66	66			69KHP13	4215
Runoff36/P: Cylinder LH 72	72			69KHR13	4291
Runoff36/P: Cylinder RH 66	66			69KHP23	4215
Runoff36/P: Cylinder RH 72	72			69KHR23	4291

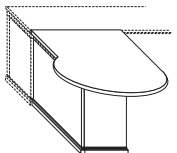

Panel-Base ‡	w	43.7d	29.9h		
• Runoff36/P: Panel-Base LH 66	66			69KHP10	4149
Runoff36/P: Panel-Base LH 72	72			69KHR10	4242
Runoff36/P: Panel-Base RH 66	66			69KHP20	4149
Runoff36/P: Panel-Base RH 72	72			69KHR20	4242

Panel-Base units must butt to a panel with toeboard detailing.

Specify: Product No.
Quantity
Tagging
Wood Finish

For quarter-sawn borders, specify
Option BA, add 50%.

• Denotes Item is illustrated.
‡ Requires field sub-assembly.



Bridge, Fixed Modesty Panel

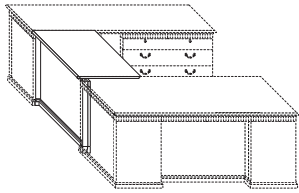

24 Depth ‡	w	24.9d	29.9h	Flush Back	Product No.	List \$	Product No.	List \$
Bridge24: 36	34.3				69GTF00	2059	69GVF00	2199
Bridge24: 42	40.3				69GTG00	2109	69GVG00	2252
• Bridge24: 48	46.3				69GTJ00	2151	69GVJ00	2293
Bridge24: 54	52.3				69GTL00	2322	69GVL00	2464

Finished back on fixed modesty panels.

Bridge, Removable Access Panel

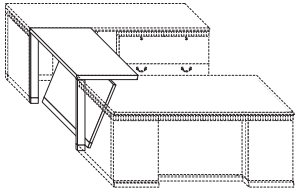

24 Depth (Unfinished Back) ‡	w	24.9d	29.9h	Flush Back	Product No.	List \$	Product No.	List \$
Bridge24/Access: 36	36.3				69GTF90	2075	69GVF90	2219
Bridge24/Access: 42	42.3				69GTG90	2116	69GVG90	2257
• Bridge24/Access: 48	48.3				69GTJ90	2156	69GVJ90	2298
Bridge24/Access: 54	54.3				69GTL90	2322	69GVL90	2464

Unfinished back on removable access panels.

Bridge, Top Only

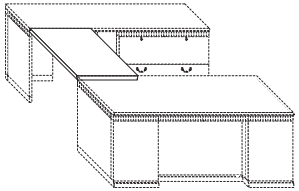

24 Depth	w	24.9d	29.9h	Flush Back	Product No.	List \$	Product No.	List \$
Bridge24Top: 36	36.3				69GWF00	1319	69GXF00	1463
Bridge24Top: 42	42.3				69GWG00	1335	69GXF00	1479
• Bridge24Top: 48	48.3				69GWJ00	1347	69GXJ00	1490
Bridge24Top: 54	54.3				69GWL00	1490	69GXL00	1633

§ Add 0.9 to depth

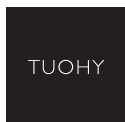

Specify: Product No.
 Quantity
 Tagging
 Wood Finish

For quarter-sawn borders, specify
 Option BA, add 50%.

- Denotes Item is illustrated.
- ‡ Requires field sub-assembly.

Product No. List \$ Product No. List \$

Credenzas—Freestanding

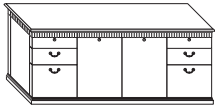

Continuous Top and Toeboards -	73.7w 25.7d 29.9h	Detail 3 Sides	
Credenza (3s): 2BF x 4		69CZR00	7281
• Credenza (3s): 2BF-DbiCab-2BF		69CZR01	7281
Credenza (3s): 2BF-DbiCab-2F		69CZR02	7281
Credenza (3s): 2F-DbiCab-2BF		69CZR03	7281
Credenza (3s): 2F-DbiCab-2F		69CZR04	7281
Credenza (3s): 2BF-Knee-2BF		69CZR31	6982
Credenza (3s): 2BF-Knee-2F		69CZR32	6982
Credenza (3s): 2F-Knee-2BF		69CZR33	6982
Credenza (3s): 2F-Knee-2F		69CZR34	6982
Credenza (3s): 2LatF-2LatF		69CZR35	6950

Backs are unfinished.

Credenzas—Sideboard

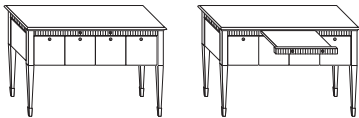

	w	d	h	Detail 3 Sides
• Credenza/Sideboard	55.3	18.9	36	69CZR90 3853

Sideboard includes a pull-out shelf.
Backs are unfinished.

Corner Credenzas

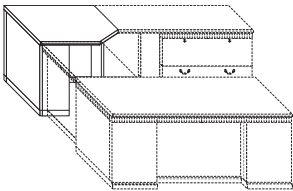

Attach Runoffs/Bridges a: b	w	d	29.9h	Flush Ends/Back
• CornerCredenza 24:24	36.9	36.9		69LLCC0 1565
CornerCredenza 24:30	36.9	42.9		69LLCD0 1766
CornerCredenza 24:36	36.9	48.9		69LLCF0 1939
CornerCredenza 30:24	42.9	36.9		69LLDC0 1766
CornerCredenza 30:30	42.9	42.9		69LLDD0 1954
CornerCredenza 30:36	42.9	48.9		69LLDF0 2115
CornerCredenza 36:24	48.9	36.9		69LLFC0 1939
CornerCredenza 36:30	48.9	42.9		69LLFD0 2115
CornerCredenza 36:36	48.9	48.9		69LLFF0 2318

Backs are unfinished.
Grain is long when a and b are not equal.

Grain is as shown when a and b are equal.

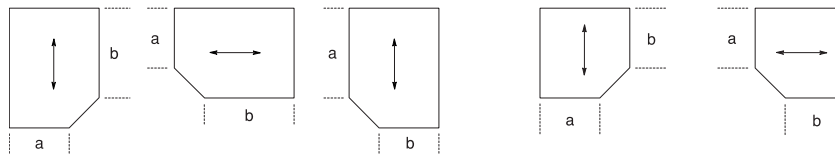

Computer Credenza Top+Base-L

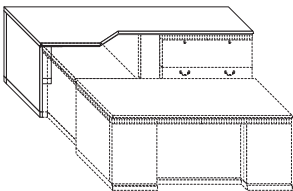

Base-L is 24x36, Unfinished Back ‡	w	36.9d 29.9h	Flush Ends/Back	§ Detail 3 Sides
CredenzaComp24: LH 72	72		69LBR31 2348	69LBR37 2777
• CredenzaComp24: LH 90	90		69LBW31 2464	69LBW37 2889
CredenzaComp24: LH 108	108		69LBY31 2696	69LBY37 3121
CredenzaComp24: RH 72	72		69LBR32 2348	69LBR38 2777
CredenzaComp24: RH 90	90		69LBW32 2464	69LBW38 2889
CredenzaComp24: RH 108	108		69LBY32 2696	69LBY38 3121

Backs are unfinished.

§ Add 0.9 to width

Computer Corner Adaptor Top

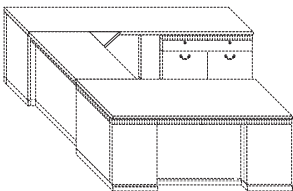

(Coped on two sides to mate with edge shapes of tops)				
Computer Corner Adaptor Top	12	12	1.5	69LCA01 277



Specify: Product No. Hardware Finish: For quarter-sawn borders, specify Option BA, add 50%.
 Quantity 712 Satin Black
 Tagging 713 Low Lustre Brass
 Wood Finish 715 Brushed Nickel
 • Denotes Item is illustrated.
 - Includes locks.
 ‡ Requires field sub-assembly.



Credenza Tops

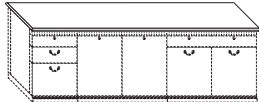
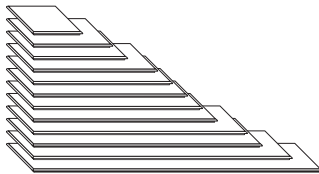
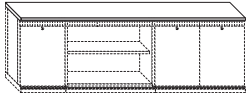
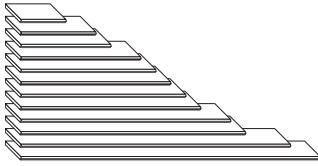

Support Keel

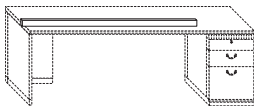

Product No. List \$ Product No. List \$

Rectangular 15 Depth	w	15.9d	1.5th	Flush Ends/Back	§	Detail 3 Sides
CredenzaTop15: 18	18			69LAA00	938	69LAA06 1114
CredenzaTop15: 30	30			69LAD00	957	69LAD06 1135
CredenzaTop15: 36	36			69LAF00	977	69LAF06 1155
CredenzaTop15: 48	48			69LAJ00	987	69LAJ06 1164
CredenzaTop15: 54	54			69LAL00	995	69LAL06 1176
CredenzaTop15: 60	60			69LAN00	1031	69LAN06 1210
CredenzaTop15: 66	66			69LAP00	1086	69LAP06 1265
CredenzaTop15: 72	72			69LAR00	1112	69LAR06 1290
CredenzaTop15: 78	78			69LAT00	1136	69LAT06 1313
CredenzaTop15: 84	84			69LAV00	1157	69LAV06 1335
• CredenzaTop15: 90	90			69LAW00	1230	69LAW06 1490
CredenzaTop15: 108	108			69LAY00	1460	69LAY06 1637
CredenzaTop15: 120	120			69LAZ00	1604	69LAZ06 1782

Rectangular 24 Depth	w	24.9d	1.5th	Flush Ends/Back	§	Detail 3 Sides
CredenzaTop24: 18	18			69LAA30	1009	69LAA36 1186
CredenzaTop24: 30	30			69LAD30	1028	69LAD36 1206
CredenzaTop24: 36	36			69LAF30	1050	69LAF36 1226
CredenzaTop24: 48	48			69LAJ30	1057	69LAJ36 1236
CredenzaTop24: 54	54			69LAL30	1068	69LAL36 1243
CredenzaTop24: 60	60			69LAN30	1103	69LAN36 1280
CredenzaTop24: 66	66			69LAP30	1170	69LAP36 1347
CredenzaTop24: 72	72			69LAR30	1196	69LAR36 1377
CredenzaTop24: 78	78			69LAT30	1241	69LAT36 1399
CredenzaTop24: 84	84			69LAV30	1265	69LAV36 1418
• CredenzaTop24: 90	90			69LAW30	1314	69LAW36 1490
CredenzaTop24: 108	108			69LAY30	1585	69LAY36 1720
CredenzaTop24: 120	120			69LAZ30	1688	69LAZ36 1866

§ Add 1.7 to width

For unsupported spans of 54 or more.	w	2d	1h	Edge Profile	Prefix not required.
Support Keel: 52	52			70LDL00	278
Support Keel: 58	58			70LDN00	293
Support Keel: 64	64			70LDP00	350
• Support Keel: 70	70			70LDR00	419
Support Keel: 82	82			70LDV00	432
Support Keel: 88	88			70LDW00	459
Support Keel: 106	106			70LDY00	487
Support Keel: 118	118			70LDZ00	556

Material is black resin-coated steel.



Specify: Product No.
Quantity
Tagging
Wood Finish

For quarter-sawn borders, specify
Option BA, add 50%.
‡ Includes locks.
‡ Requires field sub-assembly.

Base L/T/I Panels

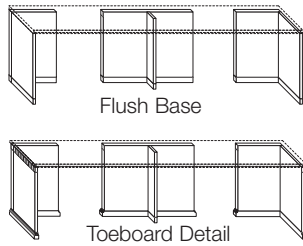

Unfinished Back ‡	w	d	28.4h	Flush Base	Product No.	List \$	Product No.	List \$
Base-L15: LH 18	18	15		71MLA10	459	69MLA18	554	
Base-L15: RH 18	18	15		71MLA20	459	69MLA28	554	
• Base-L24: LH 18	18	24		71MLA40	487	69MLA48	581	
Base-L24: LH 24	24	24		71MLC40	531	69MLC48	628	
• Base-L24: RH 18	18	24		71MLA50	487	69MLA58	581	
Base-L24: RH 24	24	24		71MLC50	531	69MLC58	628	
Base-T9: 18	18	9		71MMA00	516	69MMA08	611	
• Base-T9: 36	36	9		71MMF30	709	69MMF38	806	

Finished Back ‡	w	d	28.4h	Flush Base	Product No.	List \$	Product No.	List \$
Base-L15 Finished Back: LH 18	18	15		71MLA11	552	69MLA19	655	
Base-L15 Finished Back: RH 18	18	15		71MLA21	552	69MLA29	655	
Base-L24 Finished Back: LH 18	18	24		71MLA41	589	69MLA49	682	
Base-L24 Finished Back: LH 24	24	24		71MLC41	641	69MLC49	726	
Base-L24 Finished Back: RH 18	18	24		71MLA51	589	69MLA59	682	
Base-L24 Finished Back: RH 24	24	24		71MLC51	641	69MLC59	726	
Base-T9 Finished Back: 18	18	9		71MMA01	613	69MMA09	712	
Base-T9 Finished Back: 36	36	9		71MMF31	805	69MMF39	907	

§ Add 1.2 to w, d

Modesty Panels, Fixed

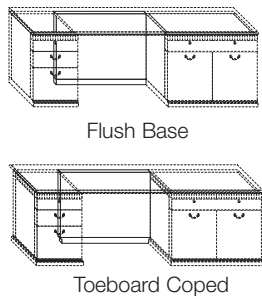

Unfinished Back ‡	w	1d	28.4h	Flush Base	Product No.	List \$	Product No.	List \$
Modesty-Panel: 18	18			69MPA00	421	69MQA00	507	
Modesty-Panel: 24	24			69MPC00	434	69MQC00	523	
Modesty-Panel: 30	30			69MPD00	496	69MQD00	584	
• Modesty-Panel: 36	36			69MPF00	545	69MQF00	632	
Modesty-Panel: 42	42			69MPH00	570	69MQH00	656	
Modesty-Panel: 48	48			69MPJ00	599	69MQJ00	686	
Modesty-Panel: 54	54			69MPL00	623	69MQL00	710	
Modesty-Panel: 72	72			69MPR00	697	69MQR00	785	

Finished Back ‡	w	1d	28.4h	Flush Base	Product No.	List \$	Product No.	List \$
Modesty-Panel Finished Back: 18	18			69MPA01	576	69MQA01	660	
Modesty-Panel Finished Back: 24	24			69MPC01	596	69MQC01	680	
Modesty-Panel Finished Back: 30	30			69MPD01	665	69MQD01	752	
Modesty-Panel Finished Back: 36	36			69MPF01	723	69MQF01	809	
Modesty-Panel Finished Back: 42	42			69MPH01	752	69MQH01	837	
Modesty-Panel Finished Back: 48	48			69MPJ01	790	69MQJ01	877	
Modesty-Panel Finished Back: 54	54			69MPL01	816	69MQL01	902	
Modesty-Panel Finished Back: 72	72			69MPR01	911	69MQR01	994	

§ Add 0.6 to depth

Modesty Panels, Access/Removable

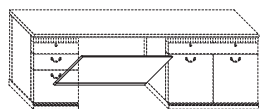

Unfinished Back (2.5 opening at top) ‡	w	3d	25.9h	Flush Base	Product No.	List \$
Modesty-Access: 18	18			69MPA90	567	
Modesty-Access: 24	24			69MPC90	581	
Modesty-Access: 30	30			69MPD90	627	
• Modesty-Access: 36	36			69MPF90	671	
Modesty-Access: 42	42			69MPH90	695	
Modesty-Access: 48	48			69MPJ90	723	
Modesty-Access: 54	54			69MPL90	747	
Modesty-Access: 72	72			69MPR90	834	

Specify: Product No.
Quantity
Tagging
Wood Finish

For quarter-sawn borders, specify
Option BA, add 50%.

• Denotes Item is illustrated.
‡ Requires field sub-assembly.

Pedestals

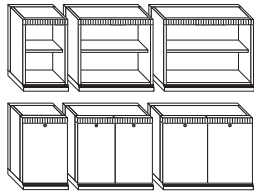

			Product No.	List \$	Product No.	List \$
15 Deep Shelving	w	15.6d 28.4h	Flush 3 Sides		§ Toebd 4 Sides	
Ped15: Shelving 18	18		69MEA00	1161	69MEA01	1572
Ped15: Shelving 30	30		69MED00	1453	69MED01	1864
Ped15: Shelving 36	36		69MEF00	1583	69MEF01	1995
15 Deep Cabinets -	w	15.6d 28.4h	Flush 3 Sides		§ Toebd 4 Sides	
Ped15: Cabinet LH 18	18		69MDA10	1526	69MDA11	1937
Ped15: Cabinet RH 18	18		69MDA20	1526	69MDA21	1937
Ped15: DbCabinet 30	30		69MDD00	1740	69MDD01	2152
Ped15: DbCabinet 36	36		69MDF00	1873	69MDF01	2288

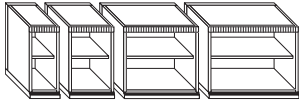

24 Deep Shelving	w	24.6d 28.4h	Flush 3 Sides		§ Toebd 4 Sides	
Ped24: ShelvingPC 12	12		69ME030	1217	69ME031	1597
Ped24: Shelving 18	18		69MEA30	1399	69MEA31	1772
Ped24: Shelving 30	30		69MED30	1714	69MED31	2126
Ped24: Shelving 36	36		69MEF30	1848	69MEF31	2263

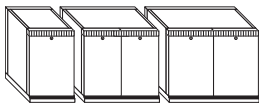

24 Deep Cabinets -	w	24.6d 28.4h	Flush 3 Sides		§ Toebd 4 Sides	
Ped24: Cabinet LH 18	18		69MDA40	1744	69MDA41	2121
Ped24: Cabinet RH 18	18		69MDA50	1744	69MDA51	2121
Ped24: DbCabinet 30	30		69MDD30	1925	69MDD31	2339
Ped24: DbCabinet 36	36		69MDF30	2034	69MDF31	2445

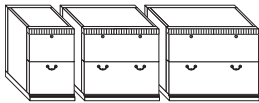

24 Deep File Drawers -	w	24.6d 28.4h	Flush 3 Sides		§ Toebd 4 Sides	
Ped24: 2F 18	18		69MBA30	2039	69MBA31	2414
Ped24: 2LatF 30	30		69MBD30	2402	69MBD31	2815
Ped24: 2LatF 36	36		69MBF30	2603	69MBF31	3016



24 Deep 2Box-File Drawers -	w	24.6d 28.4h	Flush 3 Sides		§ Toebd 4 Sides	
Ped24: 2BF 18	18		69MAA30	2039	69MAA31	2414
Ped24: 2LatB/LatF 30	30		69MAD30	2584	69MAD31	2999
Ped24: 2LatB/LatF 36	36		69MAF30	2780	69MAF31	3193

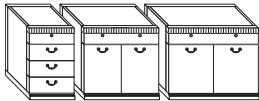

24 Deep 4Box and Box/Cabinets -	w	24.6d 28.4h	Flush 3 Sides		§ Toebd 4 Sides	
Ped24: 4B 18	18		69MCA30	2109	69MCA31	2483
Ped24: LatB/DbCab 30	30		69MFD30	2473	69MFD31	2885
Ped24: LatB/DbCab 36	36		69MFF30	2667	69MFF31	3077



30 Deep (For Galleries) -	18w	30d 28.4h	Flush 3 Sides			
Ped30: 2F 18			69MBAD0	2071		
Ped30: 2BF 18			69MAAD0	2071		



36 Deep (For Galleries) -	18w	36d 28.4h	Flush 3 Sides			
Ped36: 2F 18			69MBAG0	2479		
Ped36: 2BF 18			69MAAG0	2479		

§ Add 0.6d, 1.3w

Pedestals that are Flush 3 sides have unfinished backs; otherwise pedestals are finished all sides.



Flush 3 Sides



Toebd 4 Sides

+ Options:

For Toeboards Front & Back: Use Flush 3 Sides number, change last digit to 8, add \$221.

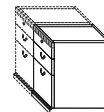

Toeboards Front+Back:



Specify:	Product No.	Hardware Finish:	For quarter-sawn borders, specify
	Quantity	712 Satin Black	Option BA, add 50%.
	Tagging	713 Low Lustre Brass	
	Wood Finish	715 Brushed Nickel	

- Denotes Item is illustrated.
- Includes locks.
- ‡ Requires field sub-assembly.



Hutch72

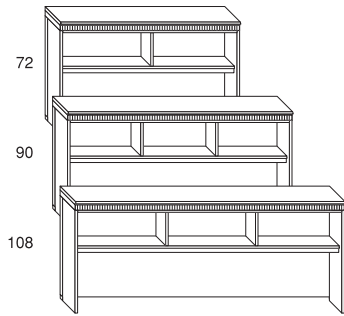

Shelving1 w. Wood Back	w	Sgl\Ndbl Shlvs	Flush Ends/Back	\$ Detail 3 Sides	Product No.	List \$	Product No.	List \$
Hutch72: Shelving1 72	72	0\2	69PAR00	3760	69PAR07	4114		
Hutch72: Shelving1 90	90	1\2	69PAW00	4245	69PAW07	4599		
Hutch72: Shelving1 108	108	0\3	69PAY00	4542	69PAY07	4900		

Shelving1 w. Fabric Panel	w	Sgl\Ndbl Shlvs	COM yd	Flush Ends/Back	\$ Detail 3 Sides	Product No.	List \$	Product No.	List \$
Hutch72: Shelving1/Fab 72	72	0\2	2.3	69PAR30	4257	69PAR37	4612		
Hutch72: Shelving1/Fab 90	90	0\3	2.8	69PAW30	4815	69PAW37	5166		
Hutch72: Shelving1/Fab 108	108	0\3	3.2	69PAY30	5148	69PAY37	5502		

Dimensions: width as listed 15d 45h § Add 1.7 to width
Note: Fabric Panels over 96w are produced in two sections.

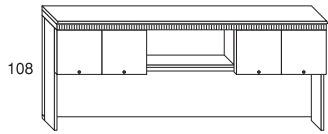

Cabinet1-Shelf w. Wood Back	w	Sgl\Ndbl Shlvs	Flush Ends/Back	\$ Detail 3 Sides	Product No.	List \$	Product No.	List \$
Hutch72: Cab1-Shelf1-Cab1 108	108	0\3	69PFY00	5069	69PFY07	5457		

Cabinet1-Shelf w. Fabric Panel	w	Sgl\Ndbl Shlvs	COM yd	Flush Ends/Back	\$ Detail 3 Sides	Product No.	List \$	Product No.	List \$
Hutch72: Cab1-Shelf1-Cab1/Fab 108	108	0\3	3.2	69PFY30	5673	69PFY37	6062		

Dimensions: width as listed 15d 45h § Add 1.7 to width
Note: Fabric Panels over 96w are produced in two sections.

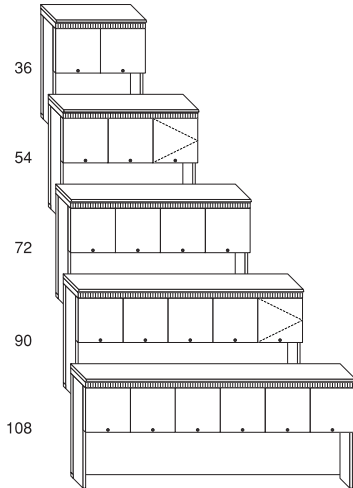

Cabinet1 w. Wood Back	w	Sgl\Ndbl Shlvs	Flush Ends/Back	\$ Detail 3 Sides	Product No.	List \$	Product No.	List \$
Hutch72: Cabinet1 36	36	0\1	69PCF00	3010	69PCF07	3401		
Hutch72: Cabinet1 54	54	1\1	69PCL00	4046	69PCL07	4437		
Hutch72: Cabinet1 72	72	0\2	69PCR00	4543	69PCR07	4934		
Hutch72: Cabinet1 90	90	1\2	69PCW00	4882	69PCW07	5274		
Hutch72: Cabinet1 108	108	0\3	69PCY00	5241	69PCY07	5629		

Cabinet1 w. Fabric Panel	w	Sgl\Ndbl Shlvs	COM yd	Flush Ends/Back	\$ Detail 3 Sides	Product No.	List \$	Product No.	List \$
Hutch72: Cabinet1/Fab 36	36	0\1	1.8	69PCF30	3295	69PCF37	3684		
Hutch72: Cabinet1/Fab 54	54	1\1	2	69PCL30	4507	69PCL37	4900		
Hutch72: Cabinet1/Fab 72	72	0\2	2.3	69PCR30	5044	69PCR37	5432		
Hutch72: Cabinet1/Fab 90	90	1\2	2.8	69PCW30	5452	69PCW37	5841		
Hutch72: Cabinet1/Fab 108	108	0\3	3.2	69PCY30	5841	69PCY37	6233		

Dimensions: width as listed 15d 45h § Add 1.7 to width
Note: Fabric Panels over 96w are produced in two sections.

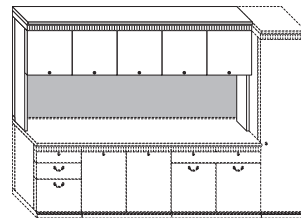

Cabinet1 Hutch w. Fabric Panel
Flush Ends/Back

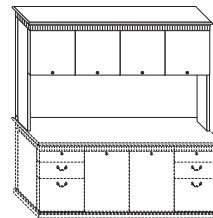

Cabinet1 Hutch w. Wood Back
Detail 3 Sides



Specify: Product No. Hardware Finish: For quarter-sawn borders on doors, specify Option BA, add 50%.
Quantity 712 Satin Black
Tagging 713 Low Lustre Brass
Wood Finish 715 Brushed Nickel
- Includes locks.
‡ Requires field sub-assembly.



Hutch72 (cont.)

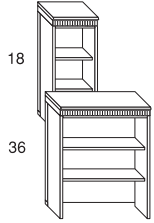

Shelving3 w. Wood Back	w	Sgl\Ndbl Shlvs	Flush Ends/Back	§ Detail	3 Sides
Hutch72: Shelving3 18	18	3\0	69PBA00 2373	69PBA07	2516
Hutch72: Shelving3 36	36	0\3	69PBF00 2918	69PBF07	3305

Dimensions: width as listed 15d 45h
Includes one fixed shelf and one adjustable shelf.

§ Add 1.7 to width

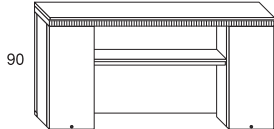

Cab3-Shelf1 w. Wood Back	w	Sgl\Ndbl Shlvs	Flush Ends/Back	§ Detail	3 Sides
Hutch72: Cab3-Shelf1-Cab3 90	90	6\1	69PGW00 5725	69PGW07	6113

Cab3-Shelf1 w. Fabric Panel	w	Sgl\Ndbl Shlvs	Flush Ends/Back	COM yd	§ Detail	3 Sides
Hutch72: Cab3-Shelf1/Fab-Cab3 90	90	6\1 2	69PGW30 6184	69PGW37	6572	

Dimensions: width as listed 15d 45h

§ Add 1.7 to width

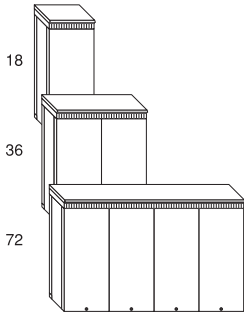

Full Wood Doors	w	Sgl\Ndbl Shlvs	Flush Ends/Back	§ Detail	3 Sides
Hutch72: Cabinet3 LH 18	18	3\0	69PEA10 2696	69PEA17	2836
Hutch72: Cabinet3 RH 18	18	3\0	69PEA20 2696	69PEA27	2836
Hutch72: Cabinet3 36	36	0\3	69PEF00 3452	69PEF07	3841
Hutch72: Cabinet3 72	72	0\6	69PER00 6076	69PER07	6289

Dimensions: width as listed 15d 45h

§ Add 1.7 to width

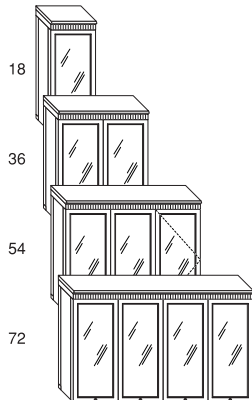

Full Glass Doors	w	Sgl\Ndbl Shlvs	Flush Ends/Back	§ Detail	3 Sides
Hutch72: GlassDrs3 LH 18	18	3\0	69PKA10 3582	69PKA17	3724
Hutch72: GlassDrs3 RH 18	18	3\0	69PKA20 3582	69PKA27	3724
Hutch72: GlassDrs3 36	36	0\3	69PKF00 4588	69PKF07	4978
Hutch72: GlassDrs3 54	54	3\3	69PKL00 6459	69PKL07	6850
Hutch72: GlassDrs3 72	72	0\6	69PKR00 8348	69PKR07	8774

Dimensions: width as listed 15d 45h
Includes clear glass shelves and low voltage halogen lights.

§ Add 1.7 to width



Specify: Product No. Hardware Finish: For quarter-sawn borders, specify
Quantity 712 Satin Black Option BA, add 50%.
Tagging 713 Low Lustre Brass - Includes locks.
Wood Finish 715 Brushed Nickel ‡ Requires field sub-assembly.



ATHENEUM

FREIGHT INCLUDED
APRIL 15, 2012

Hutch85

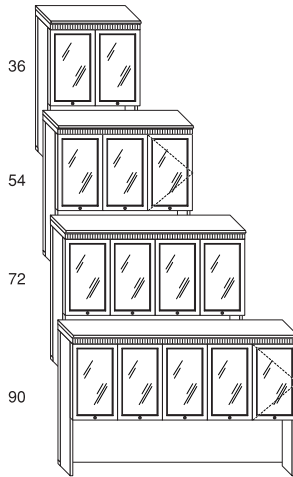
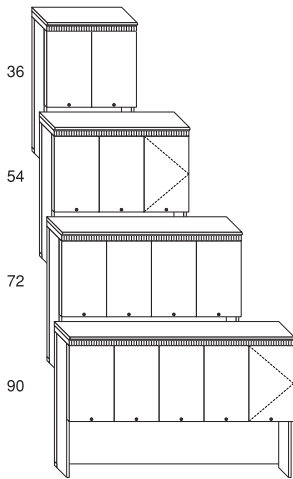

Product No. List \$ Product No. List \$

Cabinet2 w. Wood Back	w	Sgl\Tbl Shlvs	Flush Ends/Back	\$	Detail 3 Sides
Hutch85: Cabinet2 36	36	0\2	69PSF00	3472	69PSF07 3863
Hutch85: Cabinet2 54	54	2\2	69PSL00	4542	69PSL07 4932
Hutch85: Cabinet2 72	72	0\4	69PSR00	5077	69PSR07 5469
Hutch85: Cabinet2 90	90	2\4	69PSW00	5452	69PSW07 5841

Cabinet2 w. Fabric Panel	COM				
Hutch85: Cabinet2/Fab 36	36	0\2	1.8	69PSF30	3754 69PSF37 4144
Hutch85: Cabinet2/Fab 54	54	2\2	2	69PSL30	5005 69PSL37 5396
Hutch85: Cabinet2/Fab 72	72	0\4	2.3	69PSR30	5574 69PSR37 5964
Hutch85: Cabinet2/Fab 90	90	2\4	2.8	69PSW30	6017 69PSW37 6408

Dimensions: width as listed 15d 57.6h

§ Add 1.7 to width

Glass Doors2 w. Wood Back	w	Sgl\Tbl Shlvs	Flush Ends/Back	\$	Detail 3 Sides
Hutch85: GlassDrs2 36	36	0\2	69PWF00	4536	69PWF07 4926
Hutch85: GlassDrs2 54	54	2\2	69PWL00	6141	69PWL07 6532
Hutch85: GlassDrs2 72	72	0\8	69PWR00	6970	69PWR07 7598
Hutch85: GlassDrs2 90	90	2\4	69PWW00	8111	69PWW07 8503

Glass Doors2 w. Fabric Panel	COM				
Hutch85: GlassDrs2/Fab 36	36	0\2	1.8	69PWF30	4820 69PWF37 5210
Hutch85: GlassDrs2/Fab 54	54	2\2	2	69PWL30	6603 69PWL37 6994
Hutch85: GlassDrs2/Fab 72	72	0\4	2.3	69PWR30	7703 69PWR37 8095
Hutch85: GlassDrs2/Fab 90	90	2\4	2.8	69PWW30	8683 69PWW37 9071

Dimensions: width as listed 15d 57.6h

§ Add 1.7 to width

Includes clear glass shelves and low voltage halogen lights.



Specify: Product No.
Quantity
Tagging
Wood Finish

Hardware Finish:
712 Satin Black
713 Low Lustre Brass
715 Brushed Nickel

For quarter-sawn borders on doors,
specify Option BA, add 50%.

• Denotes Item is illustrated.
‡ Requires field sub-assembly.

TUOHY

Hutch85 (cont.)

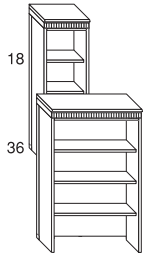

Shelving4 Hutch	w	Sgl\Tbl Shlvs	Flush Ends/Back	§ Detail 3 Sides
Hutch85: Shelving4 18	18	4\0	69PQA00 2516	69PQA07 2870
Hutch85: Shelving4 36	36	0\4	69PQF00 3339	69PQF07 3732

Dimensions: width as listed 15d 57.6h
Includes one fixed shelf and two adjustable shelves.

§ Add 1.7 to width

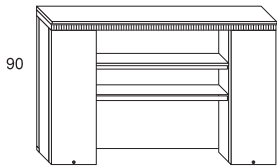

Cab4-Shelf2 w. Wood Back	w	Sgl\Tbl Shlvs	Flush Ends/Back	§ Detail 3 Sides
Hutch85: Cab4-Shelf2-Cab4 90	90	8\2	69PVW00 6290	69PVW07 6682

Cab4-Shelf2 w. Fabric Panel	COM			
Hutch85: Cab4-Shelf2/Fab-Cab4 90	90	8\2 2	69PVW30 6754	69PVW37 7143

Dimensions: width as listed 15d 57.6h

§ Add 1.7 to width

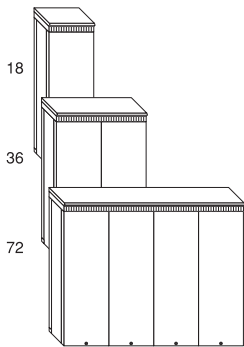

Full Wood Doors	w	Sgl\Tbl Shlvs	Flush Ends/Back	§ Detail 3 Sides
Hutch85: Cabinet4 LH 18	18	4\0	69PTA10 2906	69PTA17 3261
Hutch85: Cabinet4 RH 18	18	4\0	69PTA20 2906	69PTA27 3261
Hutch85: Cabinet4 36	36	0\4	69PTF00 3913	69PTF07 4302
Hutch85: Cabinet4 72	72	0\4	69PTR00 6793	69PTR07 7184

Dimensions: width as listed 15d 57.6h

§ Add 1.7 to width

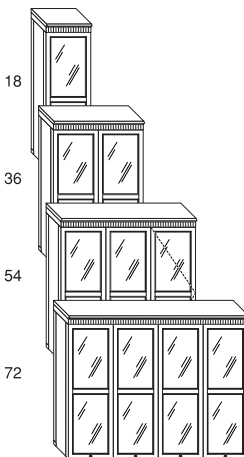

Full Glass Doors	w	Sgl\Tbl Shlvs	Flush Ends/Back	§ Detail 3 Sides
Hutch85: GlassDrs4 LH 18	18	4\0	69PXA10 3942	69PXA17 4299
Hutch85: GlassDrs4 RH 18	18	4\0	69PXA20 3942	69PXA27 4299
Hutch85: GlassDrs4 36	36	0\4	69PXF00 5120	69PXF07 5509
Hutch85: GlassDrs4 54	54	4\4	69PXL00 7242	69PXL07 7631
Hutch85: GlassDrs4 72	72	0\8	69PXR00 9383	69PXR07 9811

Dimensions: width as listed 15d 57.6h
Includes clear glass shelves and low voltage halogen lights.

§ Add 1.7 to width

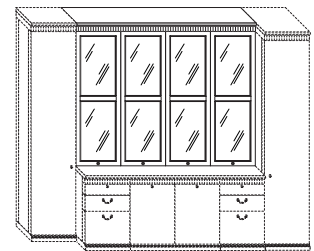

Specify: Product No. Hardware Finish: For quarter-sawn borders, specify
Quantity 712 Satin Black Option BA, add 50%.
Tagging 713 Low Lustre Brass
Wood Finish 715 Brushed Nickel
• Denotes Item is illustrated.
‡ Requires field sub-assembly.



Product No. List \$

Hutch Accessories

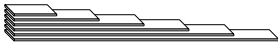
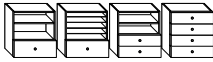
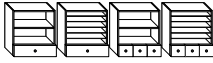

17w Minitowers	17w	d	18h		
Minitower 1: Wood3		10.2		70PZA01	1114
Minitower 2: Metal7		10.2		70PZA02	696
Minitower 3: Wood2-Dwr1		11		70PZA03	1533
Minitower 4: Metal5-Wood1-Dwr1		11		70PZA04	1463
Minitower 5: Wood2-Trio1		11		70PZA05	1216
Minitower 6: Metal5-Wood1-Trio1		11		70PZA06	1254
Minitower 7: Wood2-Disk1		11		70PZA07	1463
Minitower 8: Metal4-Wood1-Disk1		11		70PZA08	1320
Minitower 9: Wood2-Dwr2		11		70PZA09	1254
Minitower10: Dwr4		11		70PZA10	1811

8.5w Minitowers	w	d	h		
Minitower 20: Wood3	8.5	10.2	18	70PZA20	752
Minitower 21: Wood2-CD1	8.5	11	18	70PZA21	1086
Minitower 22: Wood1-Disk2	8.5	11	18	70PZA22	1380
Minitower 23: Dwr1-Disk2	8.5	11	18	70PZA23	1573
Minitower 24: Dwr2-CD1	8.5	11	18	70PZA24	1601
Minitower 25: CD2	8.5	11	18	70PZA25	1533
CD Holder Tray Insert (CD drawers only)				70PZA26	42
Humidor Insert (CD drawers only)				70PZA27	730

Intermediate Shlvs: Bullnose Edge ‡	w	11.4d	0.8th		
Intermed Shelf: 18 (Minitower Top)	17			70PZA31	140
Intermed Shelf: 36	34			70PZF31	278
Intermed Shelf: 54	52			70PZL31	369
Intermed Shelf: 72	70			70PZR31	585
Intermed Shelf: 90	88			70PZW31	628
Intermed Shelf: 108	106			70PZY31	724

Intermediate Shelf Managers ‡	w	d	h		
Desktop Divider	0.5	10.2	4.6	70PZA40	71
Desktop Drawer	17	11	4.6	70PZA41	419
Desktop Trio	17	11	4.6	70PZA43	835
Suspension Divider	0.5	10.2	6.4	70PZA50	71
Suspension Drawer	17	11	6.4	70PZA51	487
Suspension Trio	17	11	6.4	70PZA53	907
Suspension Drawer8	8.5	11	6.4	70PZA54	389



Specify: Product No. Hardware Finish: ‡ Requires field sub-assembly.
 Quantity 712 Satin Black
 Tagging 713 Low Lustre Brass
 Wood Finish 715 Brushed Nickel



Product No. List \$

Hutch Accessories (cont.)

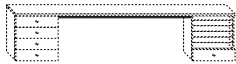
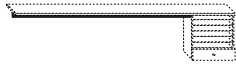

Support Fascia: Qtr Rnd w. Stl Angle ‡	w	1.7d	2.1h	Product No.	List \$
Fascia: Open-Span 36	34			70PZF60	71
Fascia: Open-Span 54	52			70PZL60	104
Fascia: Open-Span 72	70			70PZR60	133
• Fascia: Open-Span 90	88			70PZW60	169
Fascia: Open-Span 108	106			70PZY60	208
Fascia: One-Minitower 54	35			70PZL61	71
Fascia: One-Minitower 72	53			70PZR61	104
• Fascia: One-Minitower 90	71			70PZW61	140
Fascia: One-Minitower 108	89			70PZY61	169
Fascia: Two-Minitowers 72	36			70PZR62	71
• Fascia: Two-Minitowers 90	54			70PZW62	109
Fascia: Two-Minitowers 108	72			70PZY62	140

Mounting hardware included.



Specify: Product No. Hardware Finish: ‡ Requires field sub-assembly.
 Quantity 712 Satin Black
 Tagging 713 Low Lustre Brass
 Wood Finish 715 Brushed Nickel

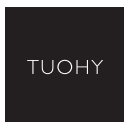

Wall Hutch

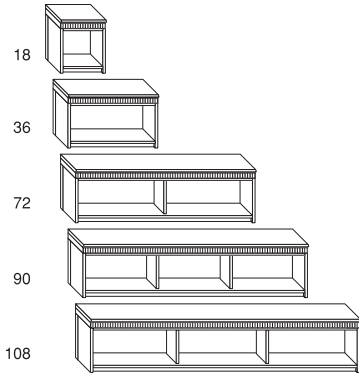

Shelving1 Wall Hatches	w	Sg\Ndbl Shlvs	Flush Ends/Back	Detail 3 Sides
Hutch: Shelving1 18	18	1\0	69QAA00 1411	69QAA07 1732
Hutch: Shelving1 36	36	0\1	69QAC00 1886	69QAC07 2240
Hutch: Shelving1 72	72	0\2	69QAR00 3358	69QAR07 3712
Hutch: Shelving1 90	90	0\3	69QAW00 3890	69QAW07 4211
Hutch: Shelving1 108	108	0\3	69QAY00 4592	69QAY07 4946

Dimensions: widths as listed 15.9d 21.7h
Mounting cleats and hardware included.

§ Add 1.7 to width

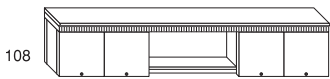

Cabinet1-Shelf1 Wall Hutch	w	Sg\Ndbl Shlvs	Flush Ends/Back	Detail 3 Sides
Hutch: Cab1-Shelf1-Cab1 108	108	0\3	69QFY00 4860	69QFY07 5215

Dimensions: widths as listed 15.9d 21.7h
Mounting cleats and hardware included.

§ Add 1.7 to width

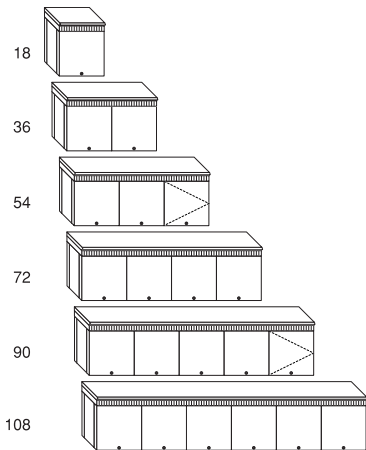

Cabinet1 Wall Hatches	w	Sg\Ndbl Shlvs	Flush Ends/Back	Detail 3 Side
Hutch: Cabinet1 LH 18	18	1\0	69QCA10 1486	69QCA17 1808
Hutch: Cabinet1 RH 18	18	1\0	69QCA20 1486	69QCA27 1808
Hutch: Cabinet1 36	36	0\1	69QCC00 2272	69QCC07 2629
Hutch: Cabinet1 54	54	1\1	69QCL00 3532	69QCL07 3885
Hutch: Cabinet1 72	72	0\2	69QCR00 4073	69QCR07 4428
Hutch: Cabinet1 90	90	1\2	69QCW00 4660	69QCW07 5016
Hutch: Cabinet1 108	108	0\3	69QCY00 5143	69QCY07 5496

Dimensions: widths as listed 15.9d 21.7h
Mounting cleats and hardware included.

§ Add 1.7 to width

Hutches with an odd number of doors have a single cabinet, hinged right, on the right end. All other doors are paired in double cabinets.

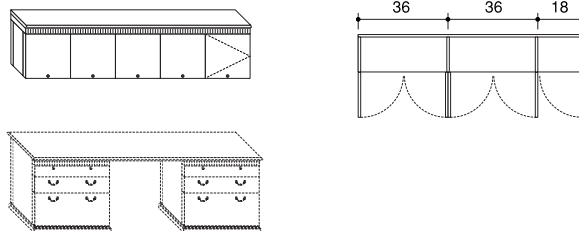

Specify: Product No. Quantity Tagging Wood Finish Hardware Finish: 712 Satin Black 713 Low Lustre Brass 715 Brushed Nickel For quarter-sawn borders, specify Option BA, add 50%. • Denotes Item is illustrated. ‡ Requires field sub-assembly.



PRIVATE OFFICE: ATHENEUM

Wall Hutch (cont.)

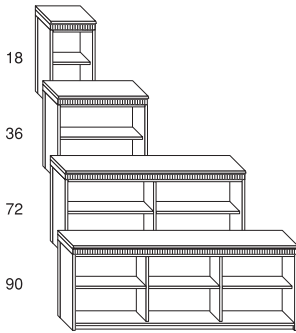

Shelving2 Wall Hatches	w	Sg\Ndbl Shlvs	Flush Ends/Back	\$	Detail	3 Sides
Hutch: Shelving2 18	18	2\0	69QNA00	1672	69QNA07	1991
Hutch: Shelving2 36	36	0\2	69QNF00	2588	69QNF07	2944
Hutch: Shelving2 72	72	0\4	69QNR00	4609	69QNR07	4965
Hutch: Shelving2 90	90	0\6	69QNW00	5309	69QNW07	5664

Dimensions: width as listed 15.9d 34.3h
Mounting cleats and hardware included.

\$Add 1.7 to width

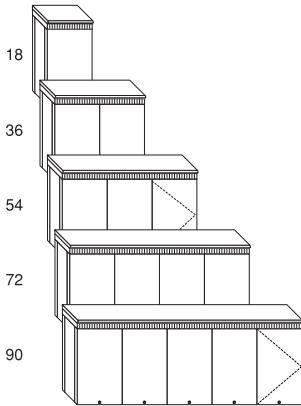

Cabinet2 Wall Hatches	w	Sg\Ndbl Shlvs	Flush Ends/Back	\$	Detail	3 Sides
Hutch: Cabinet2 LH 18	18	2\0	69QRA10	1819	69QRA17	2142
Hutch: Cabinet2 RH 18	18	2\0	69QRA20	1819	69QRA27	2142
Hutch: Cabinet2 36	36	0\2	69QRF00	2824	69QRF07	3180
Hutch: Cabinet2 54	54	2\2	69QRL00	3992	69QRL07	4348
Hutch: Cabinet2 72	72	0\4	69QRR00	5159	69QRR07	5517
Hutch: Cabinet2 90	90	2\4	69QRW00	5910	69QRW07	6264

Dimensions: width as listed 15.9d 34.3h
Mounting cleats and hardware included.

\$Add 1.7 to width

Fabric Panels, Wall Hung

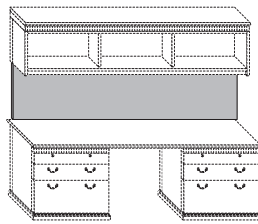

23.4 Height ‡	w	23.4h	COM	yd
Fabric Wall Panel: 36	36		1.8	70PAF11 278
Fabric Wall Panel: 54	54		2	70PAL11 453
• Fabric Wall Panel: 72	72		2.3	70PAR11 487
Fabric Wall Panel: 90	90		2.8	70PAW11 556
Fabric Wall Panel: 108	108		3.2	70PAY11 591

36 Height ‡	w	36h	COM	yd
Fabric Wall Panel: 36X	36		1.8	70PAF21 278
Fabric Wall Panel: 54X	54		2	70PAL21 453
Fabric Wall Panel: 72X	72		2.3	70PAR21 487
Fabric Wall Panel: 90X	90		2.8	70PAW21 556
Fabric Wall Panel: 108X	108		3.2	70PAY21 591

36 Height units are not recommended for use with Shelving2 or Cabinet2 Wall Hatches.

Mounting cleats and hardware included.

Wall Hung Fabric Panels allow for cord passage between the panel and the wall.

Note: Fabric Panels over 96w are produced in two sections.



Specify: Product No. Hardware Finish: For quarter-sawn borders, specify
Quantity 712 Satin Black Option BA, add 50%.
Tagging 713 Low Lustre Brass
Wood Finish 715 Brushed Nickel • Denotes Item is illustrated.
‡ Requires field sub-assembly.



Product No. List \$

Towers72

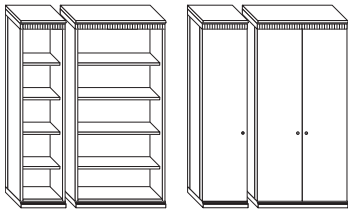

15 Deep Towers		w	15.9d	74.9h	Flush Ends/Back	
• Tower 72/15: Shelving 18	18				69TAA00	2828
• Tower 72/15: DblShelving 36	36				69TAF00	4159
• Tower 72/15: Cabinet LH 18	18				69TBA10	2947
• Tower 72/15: Cabinet RH 18	18				69TBA20	2947
• Tower 72/15: DblCabinet 36	36				69TBF00	4797

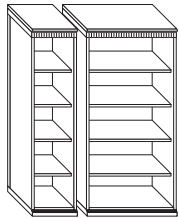

24 Deep Shelving		w	24.9d	74.9h	Flush Ends/Back	
• Tower 72/24: Shelving 18	18				69TAA30	3423
• Tower 72/24: DblShelving 36	36				69TAF30	4946

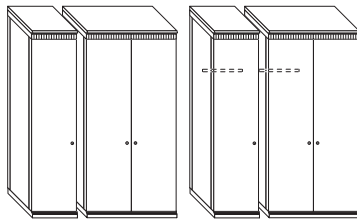

24 Deep Cabinets		w	24.9d	74.9h	Flush Ends/Back	
• Tower 72/24: Cabinet LH 18	18				69TBA40	3585
• Tower 72/24: Cabinet RH 18	18				69TBA50	3585
• Tower 72/24: DblCabinet 36	36				69TBF30	5827
• Tower 72/24: Garment LH 18	18				69TCA40	3349
• Tower 72/24: Garment RH 18	18				69TCA50	3349
• Tower 72/24: Garment:Cab 36	36				69TCF40	5588
• Tower 72/24: Cab:Garment 36	36				69TCF50	5588

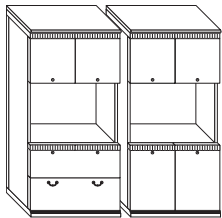

24 Deep Shelving		w	24.9d	74.9h	Flush Ends/Back	
• Tower 72/24: Cab/Shlv/LatF 36	36				69THF30	6093
• Tower 72/24: Cab/Shlv/Cab 36	36				69TJF30	5931

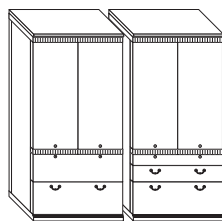

24 Deep Cabinet/Drawers		w	24.9d	74.9h	Flush Ends/Back	
• Tower 72/24: Cab/LatF 36	36				69TEF30	6345
• Tower 72/24: Cab/LatB/LatF 36	36				69TFF30	6529

Towers72/Secretarial

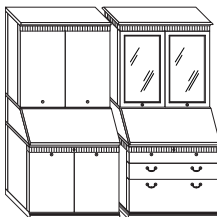

Secretarial (15d Hutch) ‡		36w	24.9d	74.9h	Flush Ends/Back		§ Detail 3 Sides
• Tower 72/24: Cab2/Secr/Cab2					69TSF10	8159	69TSF17 9124
• Tower 72/24: Cab2/Secr/LatB2/LatF					69TSF30	8886	69TSF37 9852
• Tower 72/24: Glass2/Secr/Cab2					69TSF70	9810	69TSF77 10776
• Tower 72/24: Glass2/Secr/LatB2/LatF					69TSF90	10537	69TSF97 11505

§ Add 1.7 to width

Units with glass doors include glass shelves and low voltage halogen lights.



Specify: Product No. Hardware Finish: For quarter-sawn borders, specify
 Quantity 712 Satin Black Option BA, add 50%.
 Tagging 713 Low Lustre Brass
 Wood Finish 715 Brushed Nickel
 • Denotes Item is illustrated.
 - Includes locks.
 ‡ Requires field sub-assembly.



Towers85

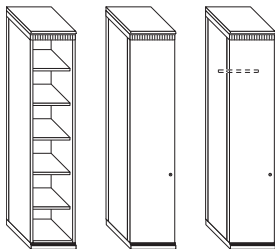
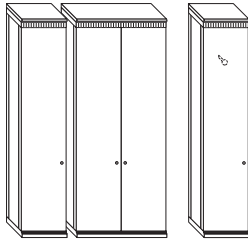
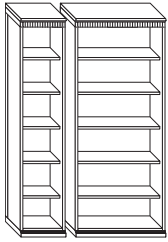

	15 Deep Shelving	w	15.9d	87.5h	Flush Ends/Back
•	Tower 85/15: Shelving 18	18			69UAA00 3124
•	Tower 85/15: DblShelving 36	36			69UAF00 4306

	15 Deep Cabinets	w	15.9d	87.5h	Flush Ends/Back
•	Tower 85/15: Cabinet LH 18	18			69UBA10 3362
•	Tower 85/15: Cabinet RH 18	18			69UBA20 3362
•	Tower 85/15: DblCabinet 36	36			69UBF00 4946
•	Tower 85/15: Garment LH 18	18			69UCA10 3247
•	Tower 85/15: Garment RH 18	18			69UCA20 3247

	24 Deep Towers	18w	24.9d	87.5h	Flush Ends/Back
•	Tower 85/24: Shelving 18				69UAA30 3751
•	Tower 85/24: Cabinet LH 18				69UBA40 4063
•	Tower 85/24: Cabinet RH 18				69UBA50 4063
•	Tower 85/24: Garment LH 18				69UCA40 3898
•	Tower 85/24: Garment RH 18				69UCA50 3898

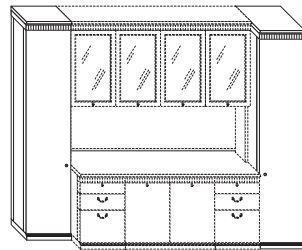

Product No. List \$

PRIVATE OFFICE: ATHENEUM



Specify: Product No. Hardware Finish: For quarter-sawn borders, specify
 Quantity 712 Satin Black Option BA, add 50%.
 Tagging 713 Low Lustre Brass
 Wood Finish 715 Brushed Nickel • Denotes Item is illustrated.
 ‡ Requires field sub-assembly.



