

SALONE COLLECTION  
SPECIFICATION GUIDE & LIST PRICES

04.15.12



TUOHY



## SALONE COLLECTION

Design:  
David Ritch & Mark Saffell, 5D Studio



TYPICALS	186	BASE L/T/I PANELS	215
DESK-TABLES W. POST LEG	188	MODESTY PANELS	215
DESK-TABLES W. LEG/PANEL	189	PEDESTALS	216
DESK-TABLES W. TRESTLE LEG	190	PEDESTALS/MOBILE	219
DESKS	191	HUTCH/PANEL	220
RUNOFFS	196	HUTCH/COLUMN	228
RUNOFF TOPS	205	HUTCH TOPS	231
BRIDGES	206	WALL HUTCH	232
BRIDGES, TOP ONLY	207	TOWERS	234
CREDENZAS	208		
CREDENZA TOPS	210		
TOP SUPPORT KEELS	213		
BASES	214		
BASE Q-PANELS	214		

SALONE TYPICALS

FREIGHT INCLUDED  
APRIL 15, 2012

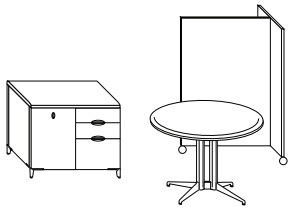

S1

DeskTbl/Round Trestle 42  
Screen 48, casters, solid color (w) hardwood veneer (24d)  
Ped24/Foot: Cabinet-2BF 36, finished back  
Credenza Top24: 36

Product No.	List \$
SAB.FGG.000	3311
SFV.BHD.012	1783
SRM.HFD.010	3184
SPA.FD0.000	985
<b>Total</b>	<b>9263</b>

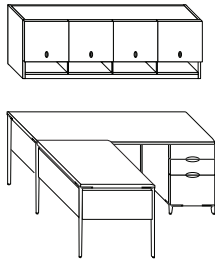

S2

Desk: Leg-2F 72x36  
Runoff30: Legs LH 54  
Hutch: Cabinet1 72, w. Cubby

SCA.CMF.B00	4230
SSH.DJE.A00	2326
SKB.AMC.L00	3105
<b>Total</b>	<b>9661</b>

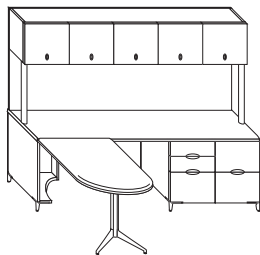

S3

Runoff30/Bullet: Trestle 60  
Credenza Top24: 90, Detail Front Only  
Base-Q24: LH 18  
Ped24/Foot: 2BF-2F 36  
Hutch72/Col: Cabinet1 90  
Power-Data / Column

SSF.FKE.000	3180
SPA.QD0.000	1250
SQB.HCD.000	705
SRR.HFD.000	3304
SKB.AQM.G00	3403
Option PC	183
<b>Total</b>	<b>12025</b>

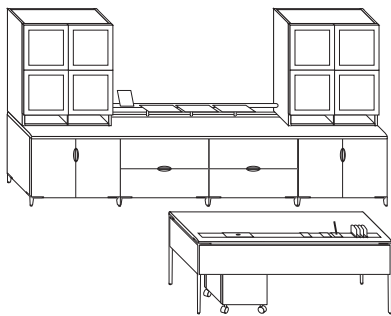

S4

DeskTbl/Pnl/Rect Parson 78x36  
Tray 72  
Tray Vertical Paper Holder  
Tray Clock  
Tray Pen Holder  
Tray Box  
Tray Power/Data Module  
Wire Raceway  
PedMobile24 (4s): 4B 18  
Ped24/Foot: DblCabinet 36  
Ped24/Foot: 2LatF 36  
Ped24/Foot: 2LatF 36  
Ped24/Foot: DblCabinet 36  
Credenza Top24: 144  
Tray 72  
Rail/Surface 72, with Tray Adaptor  
Rail Letter Tray  
Rail Picture Frame  
Hutch72: DemiGls&Shv 36, w. Cubby

SAA.DNF.000	3509
S2F.M00.000	591
S2E.F00.000	354
S2E.B00.000	118
S2E.H00.000	92
S2E.E00.000	409
S2E.K00.000	222
501.3000	60
SRK.KCD.010	1975
SRD.HFD.000	1811
SRG.HFD.000	2349
SRG.HFD.000	2349
SRD.HFD.000	1811
SPA.UD0.000	1716
S2F.M00.000	591
S2C.M00.000	809
S2D.A00.000 (Qty 3)	405
S2D.D00.000	204
SKD.CFM.E00 (Qty 2)	8712
<b>Total</b>	<b>28087</b>

Prices listed in Wood1 Finishes.

Specify: Product Number  
Quantity  
Tagging  
Wood Finish  
Hardware Finish

Worksurface trays and accessories  
have been specified from the  
Accessories & Options section of  
this price list.

TUOHY

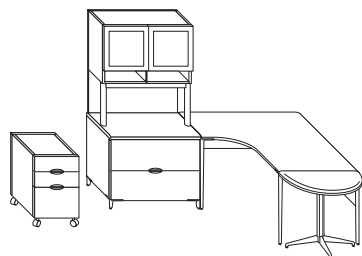

S5  
DeskTbl/CompPars 66x48 (24) LH  
Hutch72/Col: Glass1 36, w. Cubby  
Ped24/Foot: 2LatF 36  
Runoff24: LH 36  
DeskTbl/HalfRound Trestle 30  
PedMobile24 (4s): 2B-F 18

Product No.	List \$
SAD.DLH.JD0	4169
SKC.AFM.J00	2824
SRG.HFD.000	2349
SSH.TFD.A00	1102
SBB.FBE.000	2389
SRH.KCD.010	1901
<b>Total</b>	<b>14734</b>

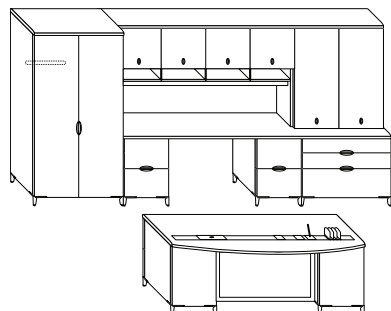

S6  
Desk/D: 2BF-2BF 78x36, glass modesty panel  
Tray 72  
Tray Wire Grommet  
Tray Vertical Paper Holder  
Tray Pen Holder  
Tray Box  
Tray Clock  
Tray Picture Frame  
Credenza Top24: 108  
Ped24/Foot: 2LatB/LatF 36  
Ped24/Foot: 2F 18  
Ped24/Foot: 2F 18  
Hutch72: Cabinet3 36  
Hutch72: Cabinet1 72, w. Cubby  
HutchTop 72^/15: 108  
Tower 72/24: Garment: Cab 36  
TowerTop 72^/24: 36

SCD.HNF.HG0	7772
S2F.M00.000	591
S2E.J00.000	133
S2E.F00.000	354
S2E.H00.000	92
S2E.E00.000	409
S2E.B00.000	118
S2E.A00.000	199
SPA.SD0.000	1407
SRJ.HFD.000	2517
SRF.HCD.000	1851
SRF.HCD.000	1851
SKB.CCM.A00	2706
SKB.AMM.E00	3407
STA.ASB.000	918
SGG.KFD.000	4566
STA.AFD.000	435
<b>Total</b>	<b>29326</b>

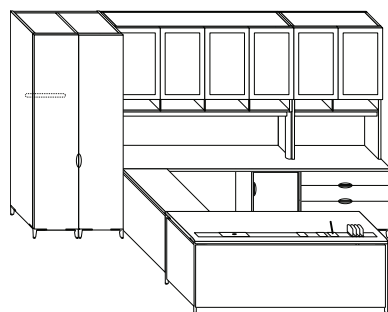

S7  
DeskTbl/Rect Parson/Pnl 78x36, Full Panel  
Tray 72  
Tray Power/Data Module  
Tray Box  
Tray Pen Holder  
Tray Clock  
Tray Wire Grommet  
Tray Vertical Paper Holder  
Bridge24/Leg-Panel 50 RH  
Credenza Top24: 108  
Support Keel: 70  
Base-Q24: LH 24  
PedMobile18 (4s): Cabinet RH 18  
Ped24/Foot: 2LatB/LatF 36  
Hutch85/Col: Glass2/Fab 72, w. Cubby  
Column / Power-Data  
Hutch85: Glass2 36, w. Cubby  
Tower 85/24: Cabinet RH 18  
Tower 85/24: Garment LH 18

SAR.JNF.000	3813
S2F.M00.000	591
S2E.K00.000	222
S2E.E00.000	409
S2E.H00.000	92
S2E.B00.000	118
S2E.J00.000	133
S2E.F00.000	354
SMA.MHD.OV0	1462
SPA.SD0.000	1407
70LDR00	419
SQB.HDD.000	753
SRC.KCC.010	1541
SRJ.HFD.000	2517
SKC.BMP.H00	5384
Option CP	183
SKB.BFP.J00	2958
SGC.MCD.000	3386
SGE.MCD.000	3231
<b>Total</b>	<b>28973</b>

Prices listed in Wood1 Finishes.

Specify: Product Number	Worksurface trays and
Quantity	accessories have been specified
Tagging	from the Accessories & Options
Wood Finish	section of this price list.
Hardware Finish	



Desk-Tables w. Post Leg

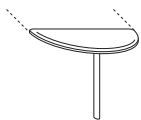
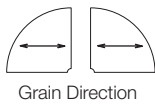
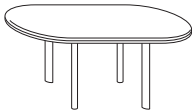
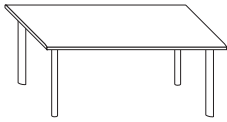
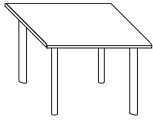

Product No. List \$ Product No. List \$

Square ‡	w	d	29.9h	Detail Front Only	Detail Front/Back
• DeskTbl/Square Post: 42x42	42	42.1		SAJ.AGG.000 2487	SAA.AGG.000 2591
DeskTbl/Square Post: 48x48	48	48.1		SAJ.AHH.000 2649	SAA.AHH.000 2769
DeskTbl/Square Post: 54x54	54	54.1		SAJ.AJJ.000 2911	SAA.AJJ.000 3054

Rectangle ‡	w	d	29.9h	Detail Front Only	Detail Front/Back
DeskTbl/Rect Post: 66x24	66	24.1		SAJ.ALD.000 2408	SAA.ALD.000 2507
DeskTbl/Rect Post: 66x30	66	30.1		SAJ.ALE.000 2514	SAA.ALE.000 2620
DeskTbl/Rect Post: 72x24	72	24.1		SAJ.AMD.000 2439	SAA.AMD.000 2541
DeskTbl/Rect Post: 72x30	72	30.1		SAJ.AME.000 2543	SAA.AME.000 2652
• DeskTbl/Rect Post: 72x36	72	36.1		SAJ.AMF.000 2654	SAA.AMF.000 2775
DeskTbl/Rect Post: 78x36	78	36.1		SAJ.ANF.000 2683	SAA.ANF.000 2805

Round Shape ‡	w	d	29.9h	Detail All Sides
DeskTbl/Round Post: 42	42	diam		SAB.AGG.000 3194
• DeskTbl/Round Post: 48	48	diam		SAB.AHH.000 3549
DeskTbl/Round Post: 54	54	diam		SAB.AJJ.000 3888

Track Shape ‡	w	d	29.9h	Detail All Sides
DeskTbl/Track Post: 72x30	72.2	30.1		SAC.AME.000 3769
• DeskTbl/Track Post: 72x36	72.2	36.1		SAC.AMF.000 4037
DeskTbl/Track Post: 78x36	78.2	36.1		SAC.ANF.000 4305

+ Options

For casters, change the 4th digit to B; add \$229.

Quarter Round (Top Only) ‡	w	d	1.5th	Flush-Cut Back	Detail Front/Back
DeskTbl/Quarter 24 LH	25.6	25.6		SBE.0DD.000 1041	SBA.0DD.000 1176
DeskTbl/Quarter 30 LH	31.6	31.6		SBE.0EE.000 1159	SBA.0EE.000 1307
DeskTbl/Quarter 36 LH	37.6	37.6		SBE.0FF.000 1275	SBA.0FF.000 1437
DeskTbl/Quarter 24 RH	25.6	25.6		SBG.0DD.000 1041	SBF.0DD.000 1176
DeskTbl/Quarter 30 RH	31.6	31.6		SBG.0EE.000 1159	SBF.0EE.000 1307
• DeskTbl/Quarter 36 RH	37.6	37.6		SBG.0FF.000 1275	SBF.0FF.000 1437

Attachment to other tables is with flat, steel straps (black).  
Provides 1.5 inches offset of ganged tables.

Half Round ‡	w	d	29.9h	Detail Front/Back
DeskTbl/HalfRound Post 30	15.1	30.2		SBB.ABE.000 1625
• DeskTbl/HalfRound Post 36	18.1	36.2		SBB.ACF.000 1740
DeskTbl/HalfRound Post 48	24.1	48.2		SBB.ADH.000 2135

Grain runs in width direction.

! Note (all Desk-Tables w. Post Leg):

All post legs are 2 x 3 inches, have an Resin Aluminum finish, and provide wire management.

Specify: Product Number  
Quantity  
Tagging  
Wood Finish  
Hardware Finish

• Denotes item illustrated  
‡ Requires field sub-assembly

Prices listed in Wood1 Finishes.

Desk-Tables w. Leg/Panel

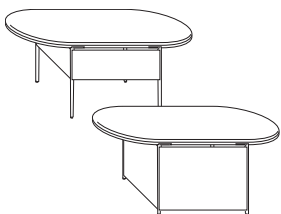
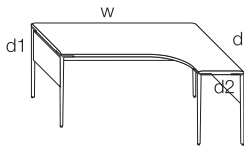
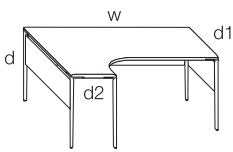
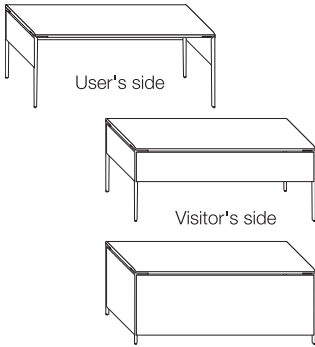

	Product No.	List \$	Product No.	List \$
Rectangle (Flush Ends)			Half Panel	Full Panel
DeskTbl/Rect Parson/Pnl 66x24	66	24.2	SAA.DLD.000 2766	SAA.JLD.000 3021
DeskTbl/Rect Parson/Pnl 66x30	66	30.2	SAA.DLE.000 2914	SAA.JLE.000 3185
DeskTbl/Rect Parson/Pnl 72x24	72	24.2	SAA.DMD.000 3151	SAA.JMD.000 3414
DeskTbl/Rect Parson/Pnl 72x30	72	30.2	SAA.DME.000 3301	SAA.JME.000 3580
• DeskTbl/Rect Parson/Pnl 72x36	72	36.2	SAA.DMF.000 3459	SAA.JMF.000 3754
DeskTbl/Rect Parson/Pnl 78x36	78	36.2	SAA.DNF.000 3509	SAA.JNF.000 3813

+ Options

For edge detailing on the user's side only (Detail Front Only), change the last digit to 8.

For LH Bridge attachment\*, change the 3rd digit to Q.

For RH Bridge attachment\*, change the 3rd digit to R.

\*Adapts corner leg for modesty panel attachment.

Computer Desk-Table LH	w	d	d1	d2	Half Panel	Full Panel
• DeskTbl/CompPars/Pnl 66x48/18 LH	66	48	30.1	18.1	SAD.DLH.JC0 4169	SAD.JLH.JC0 4466
DeskTbl/CompPars/Pnl 72x48/18 LH	72	48	30.1	18.1	SAD.DMH.JC0 4244	SAD.JMH.JC0 4548
DeskTbl/CompPars/Pnl 66x48/24 LH	66	48	30.1	24.1	SAD.DLH.JD0 4169	SAD.JLH.JD0 4466
DeskTbl/CompPars/Pnl 72x48/24 LH	72	48	30.1	24.1	SAD.DMH.JD0 4244	SAD.JMH.JD0 4548
DeskTbl/CompPars/Pnl 72x54/24 LH	72	54	36.1	24.1	SAD.DMJ.FD0 4391	SAD.JMJ.FD0 4712
DeskTbl/CompPars/Pnl 78x54/24 LH	78	54	36.1	24.1	SAD.DNJ.FD0 4465	SAD.JNJ.FD0 4794

+ Options

For edge detailing on the user's side only (Detail Front Only), change the last digit to 8.

For LH Bridge attachment at d2\*, change the 3rd digit to T.

\*Adds detail to edge d2 and adapts corner leg for modesty panel attachment.

Computer Desk-Table RH	w	d	d1	d2	Half Panel	Full Panel
• DeskTbl/CompPars/Pnl 66x48/18 RH	66	48	30.1	18.1	SAE.DLH.JC0 4169	SAE.JLH.JC0 4466
DeskTbl/CompPars/Pnl 72x48/18 RH	72	48	30.1	18.1	SAE.DMH.JC0 4244	SAE.JMH.JC0 4548
DeskTbl/CompPars/Pnl 66x48/24 RH	66	48	30.1	24.1	SAE.DLH.JD0 4169	SAE.JLH.JD0 4466
DeskTbl/CompPars/Pnl 72x48/24 RH	72	48	30.1	24.1	SAE.DMH.JD0 4244	SAE.JMH.JD0 4548
DeskTbl/CompPars/Pnl 72x54/24 RH	72	54	36.1	24.1	SAE.DMJ.FD0 4391	SAE.JMJ.FD0 4712
DeskTbl/CompPars/Pnl 78x54/24 RH	78	54	36.1	24.1	SAE.DNJ.FD0 4465	SAE.JNJ.FD0 4794

+ Options

For edge detailing on the user's side only (Detail Front Only), change the last digit to 8.

For RH Bridge attachment at d2\*, change the 3rd digit to V.

\*Adds detail to edge d2 and adapts corner leg for modesty panel attachment.

! Notes (all Computer Desk-Tables):

Edges d, d1, and d2 are flush-cut.

Edge w and the user's (curved) edge have a detail unless Detail Front Only option is specified.

Track Shape	w	d	Half Panel	Full Panel
DeskTbl/Track Parson/Pnl 72x30	72.2	30.2	SAC.DME.000 3989	SAC.JME.000 4225
• DeskTbl/Track Parson/Pnl 72x36	72.2	36.2	SAC.DMF.000 4273	SAC.JMF.000 4522
DeskTbl/Track Parson/Pnl 78x36	78.2	36.2	SAC.DNF.000 4561	SAC.JNF.000 4817

+ Options (all items this page)

For Polished Aluminum legs on Square, Rectangle and Track tables, specify Option AP; add \$698.

For Polished Aluminum legs on Computer Desk-Tables, specify Option AP; add \$874.



Specify: Product Number  
Quantity  
Tagging  
Wood Finish  
Hardware Finish

• Denotes item illustrated  
‡ Requires field sub-assembly

Prices listed in Wood1 Finishes.

Desk-Tables w. Trestle Leg

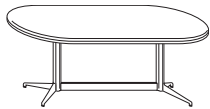
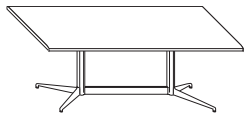

Square ‡	w	d	29.9h	Product No.	List \$	Product No.	List \$
DeskTbl/Square Trestle 36x36	36	36.1		SAJ.FFF.000	2290	SAA.FFF.000	2394

Rectangle	w	d	29.9h	Product No.	List \$	Product No.	List \$
DeskTbl/Rect Trestle 66x24	66	24.1		SAJ.FLD.000	2809	SAA.FLD.000	2907
DeskTbl/Rect Trestle 66x30	66	30.1		SAJ.FLE.000	2913	SAA.FLE.000	3019
DeskTbl/Rect Trestle 72x24	72	24.1		SAJ.FMD.000	2841	SAA.FMD.000	2943
DeskTbl/Rect Trestle 72x30	72	30.1		SAJ.FME.000	2944	SAA.FME.000	3052
• DeskTbl/Rect Trestle 72x36	72	36.1		SAJ.FMF.000	3053	SAA.FMF.000	3174
DeskTbl/Rect Trestle 78x36	78	36.1		SAJ.FNF.000	3082	SAA.FNF.000	3206

Round Shape ‡	w	d	29.9h	Product No.	List \$	Product No.	List \$
• DeskTbl/Round Trestle 42	42	diam		SAJ.FGG.000	3311		

Track Shape	w	d	29.9h	Product No.	List \$	Product No.	List \$
DeskTbl/Track Trestle 72x30	72.2	30.2		SAC.FME.000	4167		
• DeskTbl/Track Trestle 72x36	72.2	36.2		SAC.FMF.000	4436		
DeskTbl/Track Trestle 78x36	78.2	36.2		SAC.FNF.000	4702		

Base columns and stretchers (Rectangle and Track units) are Resin Aluminum.

+ Options

For casters, change the 4th digit to G; add \$229.  
For Polished Aluminum finish (legs only) on tables above, specify Option AP; add \$66.

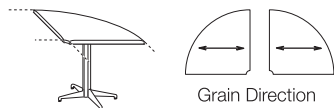

Quarter Round Open Legs ‡	31.6w-d	29.9h	Product No.	List \$	Product No.	List \$
DeskTbl/QtrRound Trestle 30 LH			SBE.FEE.000	2239	SBA.FEE.000	2389
• DeskTbl/QtrRound Trestle 30 RH			SBG.FEE.000	2239	SBF.FEE.000	2389

Provides 1.5 inches offset of ganged tables.



Half Round ‡	w	d	29.9h	Product No.	List \$	Product No.	List \$
DeskTbl/HalfRound Trestle 30	15.1	30.2		SBB.FBE.000	2389		
• DeskTbl/HalfRound Trestle 36	18.1	36.2		SBB.FCF.000	2500		
DeskTbl/HalfRound Trestle 48	24.1	48.2		SBB.FDH.000	2897		

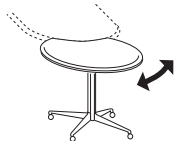

Satellite w. Casters ‡	w	d	29.9h	Product No.	List \$	Product No.	List \$
DeskTbl/Satellite Trestle 30	30	diam		SBC.GEE.000	3098		
• DeskTbl/Satellite Trestle 36	36	diam		SBC.GFF.000	3239		

Attaches to Bullet and J-Bullet tops of matching width.  
Grain direction on Half Round and Satellite tops is in-line with the adjoining top.

+ Options

For Polished Aluminum finish (legs only) on Qtr Round and Satellite tables, specify Option AP; add \$66.  
For Polished Aluminum finish (legs only) on Half Round tables, specify Option AP; add \$50.

Specify: Product Number  
Quantity  
Tagging  
Wood Finish  
Hardware Finish

• Denotes item illustrated  
‡ Requires field sub-assembly

Prices listed in Wood1 Finishes.

Desks, Double Pedestal

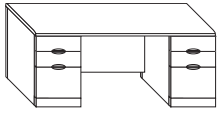

Wood Base

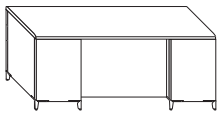
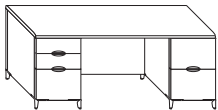
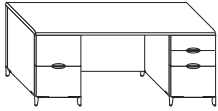

Visitor's Side

Desks, Double Pedestal w. D-Top

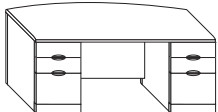

Wood Base

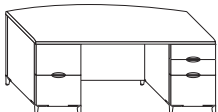

				Product No.	List \$	Product No.	List \$
2BF-2BF ↯	w	d	29.9h	Wood Base		Foot	
Desk: 2BF-2BF 66x30	66	30.2		SCB.GLE.H10	4952	SCB.HLE.H10	5496
Desk: 2BF-2BF 72x30	72	30.2		SCB.GME.H10	5013	SCB.HME.H10	5524
• Desk: 2BF-2BF 72x36	72	36.2		SCB.GMF.H10	5495	SCB.HMF.H10	6040
Desk: 2BF-2BF 78x36	78	36.2		SCB.GNF.H10	5554	SCB.HNF.H10	6101
2F-2BF ↯	w	d	29.9h	Wood Base		Foot	
Desk: 2F-2BF 66x30	66	30.2		SCB.GLE.F10	4952	SCB.HLE.F10	5496
Desk: 2F-2BF 72x30	72	30.2		SCB.GME.F10	5013	SCB.HME.F10	5524
• Desk: 2F-2BF 72x36	72	36.2		SCB.GMF.F10	5495	SCB.HMF.F10	6040
Desk: 2F-2BF 78x36	78	36.2		SCB.GNF.F10	5554	SCB.HNF.F10	6101
2BF-2F ↯	w	d	29.9h	Wood Base		Foot	
Desk: 2BF-2F 66x30	66	30.2		SCB.GLE.G10	4952	SCB.HLE.G10	5496
Desk: 2BF-2F 72x30	72	30.2		SCB.GME.G10	5013	SCB.HME.G10	5524
• Desk: 2BF-2F 72x36	72	36.2		SCB.GMF.G10	5495	SCB.HMF.G10	6040
Desk: 2BF-2F 78x36	78	36.2		SCB.GNF.G10	5554	SCB.HNF.G10	6101
2F-2F ↯	w	d	29.9h	Wood Base		Foot	
Desk: 2F-2F 66x30	66	30.2		SCB.GLE.J10	4952	SCB.HLE.J10	5496
Desk: 2F-2F 72x30	72	30.2		SCB.GME.J10	5013	SCB.HME.J10	5524
Desk: 2F-2F 72x36	72	36.2		SCB.GMF.J10	5495	SCB.HMF.J10	6040
Desk: 2F-2F 78x36	78	36.2		SCB.GNF.J10	5554	SCB.HNF.J10	6101
2BF-2BF ↯	w	d	29.9h	Wood Base		Foot	
Desk/D: 2BF-2BF 66x30	66	37.6		SCD.GLE.H10	5816	SCD.HLE.H10	6364
Desk/D: 2BF-2BF 72x30	72	38.8		SCD.GME.H10	5979	SCD.HME.H10	6391
• Desk/D: 2BF-2BF 72x36	72	44.8		SCD.GMF.H10	6510	SCD.HMF.H10	7053
Desk/D: 2BF-2BF 78x36	78	46.2		SCD.GNF.H10	6650	SCD.HNF.H10	7196
2F-2BF ↯	w	d	29.9h	Wood Base		Foot	
Desk/D: 2F-2BF 66x30	66	37.6		SCD.GLE.F10	5816	SCD.HLE.F10	6364
Desk/D: 2F-2BF 72x30	72	38.8		SCD.GME.F10	5979	SCD.HME.F10	6391
Desk/D: 2F-2BF 72x36	72	44.8		SCD.GMF.F10	6510	SCD.HMF.F10	7053
Desk/D: 2F-2BF 78x36	78	46.2		SCD.GNF.F10	6650	SCD.HNF.F10	7196
2BF-2F ↯	w	d	29.9h	Wood Base		Foot	
Desk/D: 2BF-2F 66x30	66	37.6		SCD.GLE.G10	5816	SCD.HLE.G10	6364
Desk/D: 2BF-2F 72x30	72	38.8		SCD.GME.G10	5979	SCD.HME.G10	6391
Desk/D: 2BF-2F 72x36	72	44.8		SCD.GMF.G10	6510	SCD.HMF.G10	7053
Desk/D: 2BF-2F 78x36	78	46.2		SCD.GNF.G10	6650	SCD.HNF.G10	7196
2F-2F ↯	w	d	29.9h	Wood Base		Foot	
Desk/D: 2F-2F 66x30	66	37.6		SCD.GLE.J10	5816	SCD.HLE.J10	6364
Desk/D: 2F-2F 72x30	72	38.8		SCD.GME.J10	5979	SCD.HME.J10	6391
Desk/D: 2F-2F 72x36	72	44.8		SCD.GMF.J10	6510	SCD.HMF.J10	7053
Desk/D: 2F-2F 78x36	78	46.2		SCD.GNF.J10	6650	SCD.HNF.J10	7196

+ Options

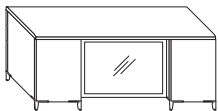

Glass Modesty Panel

Standard modesty panels are veneer.

For a solid color modesty panel, change the 8th digit from 1 to P.

For a frosted glass modesty panel, change the 8th digit from 1 to G; add 8%.

Standard finish for all pulls and feet is Resin Aluminum. For Polished Aluminum, specify Option AP:

For Polished Aluminum pulls on Wood Base units, specify Option AP; add \$74.

For Polished Aluminum pulls and feet on Foot units, specify Option AP; add \$459.

Specify: Product Number  
Quantity  
Tagging  
Wood Finish  
Hardware Finish

• Denotes item illustrated  
↯ Includes locks  
‡ Requires field sub-assembly

Prices listed in Wood1 Finishes.



Desks, Single Pedestal & Leg

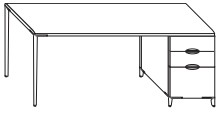

	Product No.	List \$	Product No.	List \$
Open Leg 2BF ↯			Open Leg/Foot	
Desk: Leg-2BF 66x30			SCA.CLE.A00	3894
Desk: Leg-2BF 72x30			SCA.CME.A00	3927
• Desk: Leg-2BF 72x36			SCA.CMF.A00	4230
Desk: Leg-2BF 78x36			SCA.CNF.A00	4264
Desk: 2BF-Leg 66x30			SCA.CLE.C00	3894
Desk: 2BF-Leg 72x30			SCA.CME.C00	3927
Desk: 2BF-Leg 72x36			SCA.CMF.C00	4230
Desk: 2BF-Leg 78x36			SCA.CNF.C00	4264
Open Leg 2F ↯			Open Leg/Foot	
Desk: Leg-2F 66x30			SCA.CLE.B00	3894
Desk: Leg-2F 72x30			SCA.CME.B00	3927
Desk: Leg-2F 72x36			SCA.CMF.B00	4230
Desk: Leg-2F 78x36			SCA.CNF.B00	4264
Desk: 2F-Leg 66x30			SCA.CLE.D00	3894
Desk: 2F-Leg 72x30			SCA.CME.D00	3927
Desk: 2F-Leg 72x36			SCA.CMF.D00	4230
Desk: 2F-Leg 78x36			SCA.CNF.D00	4264

After installation, units above may be readily changed in handedness by reversing the pedestal.

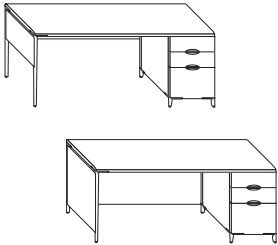

	Product No.	List \$	Product No.	List \$	Product No.	List \$
Modesty Panel 2BF ↯			Half Panel		Full Panel	
Desk: Leg/Panel-2BF 66x30			SCA.DLE.A10	4260	SCA.JLE.A10	4418
Desk: Leg/Panel-2BF 72x30			SCA.DME.A10	4311	SCA.JME.A10	4475
• Desk: Leg/Panel-2BF 72x36			SCA.DMF.A10	4634	SCA.JMF.A10	4804
Desk: Leg/Panel-2BF 78x36			SCA.DNF.A10	4684	SCA.JNF.A10	4866
Desk: 2BF-Leg/Panel 66x30			SCA.DLE.C10	4260	SCA.JLE.C10	4418
Desk: 2BF-Leg/Panel 72x30			SCA.DME.C10	4311	SCA.JME.C10	4475
Desk: 2BF-Leg/Panel 72x36			SCA.DMF.C10	4634	SCA.JMF.C10	4804
Desk: 2BF-Leg/Panel 78x36			SCA.DNF.C10	4684	SCA.JNF.C10	4866
Modesty Panel 2F ↯			Half Panel		Full Panel	
Desk: Leg/Panel-2F 66x30			SCA.DLE.B10	4260	SCA.JLE.B10	4418
Desk: Leg/Panel-2F 72x30			SCA.DME.B10	4311	SCA.JME.B10	4475
Desk: Leg/Panel-2F 72x36			SCA.DMF.B10	4634	SCA.JMF.B10	4804
Desk: Leg/Panel-2F 78x36			SCA.DNF.B10	4684	SCA.JNF.B10	4866
Desk: 2F-Leg/Panel 66x30			SCA.DLE.D10	4260	SCA.JLE.D10	4418
Desk: 2F-Leg/Panel 72x30			SCA.DME.D10	4311	SCA.JME.D10	4475
Desk: 2F-Leg/Panel 72x36			SCA.DMF.D10	4634	SCA.JMF.D10	4804
Desk: 2F-Leg/Panel 78x36			SCA.DNF.D10	4684	SCA.JNF.D10	4866

+ Options

Standard modesty panels are veneer.

For a solid color modesty panel, change the 8th digit from 1 to P.

Standard leg/foot/pull finish is Resin Aluminum. For Polished Aluminum, specify Option AP; add \$587.

For LH Bridge attachment (Leg-Pedestal)\*, change the 3rd digit to Q.

For RH Bridge attachment (Pedestal-Leg)\*, change the 3rd digit to R.

\*Adapts corner leg for modesty panel attachment.

Specify: Product Number  
Quantity  
Tagging  
Wood Finish  
Hardware Finish

• Denotes item illustrated  
↯ Includes locks  
‡ Requires field sub-assembly

Prices listed in Wood1 Finishes.

Desks, Single Pedestal

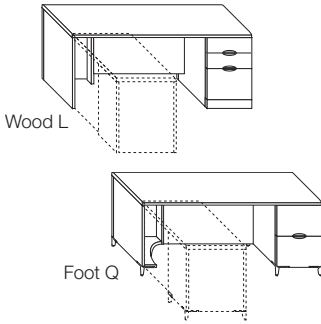

	w	d	29.9h	Product No.	List \$	Product No.	List \$
2BF ↯				Wood Base(L)		Foot (Q)	
Desk: L/QBase-2BF 66x30	66	30.2		SCA.GLE.A10	3959	SCA.HLE.A10	4535
Desk: L/QBase-2BF 72x30	72	30.2		SCA.GME.A10	4017	SCA.HME.A10	4595
• Desk: L/QBase-2BF 72x36	72	36.2		SCA.GMF.A10	4371	SCA.HMF.A10	4964
Desk: L/QBase-2BF 78x36	78	36.2		SCA.GNF.A10	4433	SCA.HNF.A10	5022
Desk: 2BF-L/QBase 66x30	66	30.2		SCA.GLE.C10	3959	SCA.HLE.C10	4535
Desk: 2BF-L/QBase 72x30	72	30.2		SCA.GME.C10	4017	SCA.HME.C10	4595
Desk: 2BF-L/QBase 72x36	72	36.2		SCA.GMF.C10	4371	SCA.HMF.C10	4964
Desk: 2BF-L/QBase 78x36	78	36.2		SCA.GNF.C10	4433	SCA.HNF.C10	5022

	w	d	29.9h	Product No.	List \$	Product No.	List \$
2F ↯				Wood Base (L)		Foot (Q)	
Desk: L/QBase-2F 66x30	66	30.2		SCA.GLE.B10	3959	SCA.HLE.B10	4535
Desk: L/QBase-2F 72x30	72	30.2		SCA.GME.B10	4017	SCA.HME.B10	4595
Desk: L/QBase-2F 72x36	72	36.2		SCA.GMF.B10	4371	SCA.HMF.B10	4964
Desk: L/QBase-2F 78x36	78	36.2		SCA.GNF.B10	4433	SCA.HNF.B10	5022
Desk: 2F-L/QBase 66x30	66	30.2		SCA.GLE.D10	3959	SCA.HLE.D10	4535
Desk: 2F-L/QBase 72x30	72	30.2		SCA.GME.D10	4017	SCA.HME.D10	4595
Desk: 2F-L/QBase 72x36	72	36.2		SCA.GMF.D10	4371	SCA.HMF.D10	4964
Desk: 2F-L/QBase 78x36	78	36.2		SCA.GNF.D10	4433	SCA.HNF.D10	5022

Desks, Single Pedestal w. D-Top

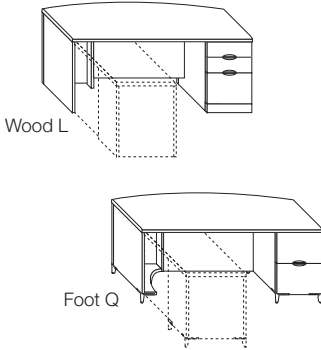

	w	d	29.9h	Product No.	List \$	Product No.	List \$
2BF ↯				Wood Base (L)		Foot (Q)	
Desk/D: L/QBase-2BF 66x30	66	37.6		SCC.GLE.A10	4825	SCC.HLE.A10	5402
Desk/D: L/QBase-2BF 72x30	72	38.8		SCC.GME.A10	4987	SCC.HME.A10	5563
• Desk/D: L/QBase-2BF 72x36	72	44.8		SCC.GMF.A10	5387	SCC.HMF.A10	5979
Desk/D: L/QBase-2BF 78x36	78	46.2		SCC.GNF.A10	5528	SCC.HNF.A10	6118
Desk/D: 2BF-L/QBase 66x30	66	37.6		SCC.GLE.C10	4825	SCC.HLE.C10	5402
Desk/D: 2BF-L/QBase 72x30	72	38.8		SCC.GME.C10	4987	SCC.HME.C10	5563
Desk/D: 2BF-L/QBase 72x36	72	44.8		SCC.GMF.C10	5387	SCC.HMF.C10	5979
Desk/D: 2BF-L/QBase 78x36	78	46.2		SCC.GNF.C10	5528	SCC.HNF.C10	6118

	w	d	29.9h	Product No.	List \$	Product No.	List \$
2F ↯				Wood Base (L)		Foot (Q)	
Desk/D: L/QBase-2F 66x30	66	37.6		SCC.GLE.B10	4825	SCC.HLE.B10	5402
Desk/D: L/QBase-2F 72x30	72	38.8		SCC.GME.B10	4987	SCC.HME.B10	5563
Desk/D: L/QBase-2F 72x36	72	44.8		SCC.GMF.B10	5387	SCC.HMF.B10	5979
Desk/D: L/QBase-2F 78x36	78	46.2		SCC.GNF.B10	5528	SCC.HNF.B10	6118
Desk/D: 2F-L/QBase 66x30	66	37.6		SCC.GLE.D10	4825	SCC.HLE.D10	5402
Desk/D: 2F-L/QBase 72x30	72	38.8		SCC.GME.D10	4987	SCC.HME.D10	5563
Desk/D: 2F-L/QBase 72x36	72	44.8		SCC.GMF.D10	5387	SCC.HMF.D10	5979
Desk/D: 2F-L/QBase 78x36	78	46.2		SCC.GNF.D10	5528	SCC.HNF.D10	6118

+ Options (all items this page)

Standard modesty panels are veneer.

For a solid color modesty panel, change the 8th digit from 1 to P.

For a frosted glass modesty panel, change the 8th digit from 1 to G; add 8%.

Standard finish for all pulls and feet is Resin Aluminum. For Polished Aluminum, specify Option AP:

For Polished Aluminum pulls on Wood Base units, specify Option AP; add \$35.

For Polished Aluminum pulls and feet on Foot units, specify Option AP; add \$374.



Specify: Product Number  
Quantity  
Tagging  
Wood Finish  
Hardware Finish

• Denotes item illustrated  
↯ Includes locks  
‡ Requires field sub-assembly

Prices listed in Wood1 Finishes.

Desks w. Bullet Top

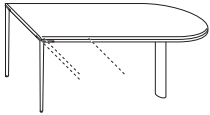

	Product No.	List \$
Parson Leg & Oval Leg ‡	w d 29.9h	
Desk/Bullet: Parson-Oval 66x30	66.1 30.2	SDD.JLE.A00 3618
Desk/Bullet: Parson-Oval 72x30	72.1 30.2	SDD.JME.A00 3702
• Desk/Bullet: Parson-Oval 72x36	72.1 36.2	SDD.JMF.A00 3804
Desk/Bullet: Parson-Oval 78x36	78.1 36.2	SDD.JNF.A00 3936

! For use only with bridges or returns.  
Oval Legs have a Resin Aluminum finish.  
Standard parson leg finish is Resin Aluminum. For Polished Aluminum, specify Option AP; add \$350.

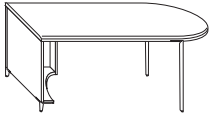

	Product No.	List \$
Q-Base w. Foot & Parson Leg ‡	w d 29.9h	
Desk/Bullet: QBase-Parson 66x30	66.1 30.2	SDA.CLE.A00 4172
Desk/Bullet: QBase-Parson 72x30	72.1 30.2	SDA.CME.A00 4255
• Desk/Bullet: QBase-Parson 72x36	72.1 36.2	SDA.CMF.A00 4421
Desk/Bullet: QBase-Parson 78x36	78.1 36.2	SDA.CNF.A00 4555
Desk/Bullet: Parson-QBase 66x30	66.1 30.2	SDA.CLE.B00 4172
Desk/Bullet: Parson-QBase 72x30	72.1 30.2	SDA.CME.B00 4255
Desk/Bullet: Parson-QBase 72x36	72.1 36.2	SDA.CMF.B00 4421
Desk/Bullet: Parson-QBase 78x36	78.1 36.2	SDA.CNF.B00 4555

Standard foot/leg finish is Resin Aluminum. For Polished Aluminum, specify Option AP; add \$501.

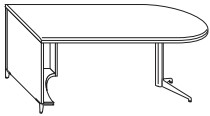

	Product No.	List \$
Q-Base w. Foot & Trestle ‡	w d 29.9h	
Desk/Bullet: QBase-Trestle 66x30	66.1 30.2	SDA.FLE.A00 4241
Desk/Bullet: QBase-Trestle 72x30	72.1 30.2	SDA.FME.A00 4321
• Desk/Bullet: QBase-Trestle 72x36	72.1 36.2	SDA.FMF.A00 4488
Desk/Bullet: QBase-Trestle 78x36	78.1 36.2	SDA.FNF.A00 4622
Desk/Bullet: Trestle-QBase 66x30	66.1 30.2	SDA.FLE.B00 4241
Desk/Bullet: Trestle-QBase 72x30	72.1 30.2	SDA.FME.B00 4321
Desk/Bullet: Trestle-QBase 72x36	72.1 36.2	SDA.FMF.B00 4488
Desk/Bullet: Trestle-QBase 78x36	78.1 36.2	SDA.FNF.B00 4622

Trestle columns have a Resin Aluminum finish.  
Q-Base Foot & Trestle leg finish is Resin Alum. For Polished Aluminum, specify Option AP; add \$184.

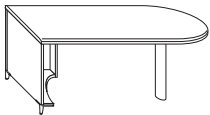

	Product No.	List \$
Q-Base w. Foot & Oval Leg ‡	w d 29.9h	
Desk/Bullet: QBase-Oval 66x30	66.1 30.2	SDA.JLE.A00 4015
Desk/Bullet: QBase-Oval 72x30	72.1 30.2	SDA.JME.A00 4094
• Desk/Bullet: QBase-Oval 72x36	72.1 36.2	SDA.JMF.A00 4263
Desk/Bullet: QBase-Oval 78x36	78.1 36.2	SDA.JNF.A00 4394
Desk/Bullet: Oval-QBase 66x30	66.1 30.2	SDA.JLE.B00 4015
Desk/Bullet: Oval-QBase 72x30	72.1 30.2	SDA.JME.B00 4094
Desk/Bullet: Oval-QBase 72x36	72.1 36.2	SDA.JMF.B00 4263
Desk/Bullet: Oval-QBase 78x36	78.1 36.2	SDA.JNF.B00 4394

! For use only with bridges or returns.  
Oval Legs have a Resin Aluminum finish.  
Q-Base Foot finish is Resin Aluminum. For Polished Aluminum, specify Option AP; add \$152.

PRIVATE OFFICE: SALONE

Specify: Product Number  
Quantity  
Tagging  
Wood Finish  
Hardware Finish

• Denotes item illustrated  
‡ Requires field sub-assembly

Prices listed in Wood1 Finishes.



Desks w. Bullet Top (cont.)

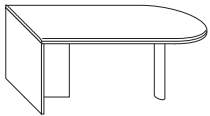
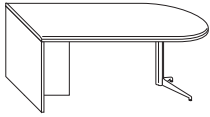
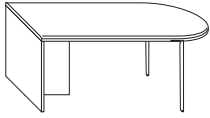

T-Base & Parson Leg ‡	w	d	29.9h	Wood Base	Product No.	List \$
Desk/Bullet: Parson-TBase 66x30	66.1	30.2		SDB.CLE.A00		3868
Desk/Bullet: Parson-TBase 72x30	72.1	30.2		SDB.CME.A00		3949
• Desk/Bullet: Parson-TBase 72x36	72.1	36.2		SDB.CMF.A00		4105
Desk/Bullet: Parson-TBase 78x36	78.1	36.2		SDB.CNF.A00		4238

Parson leg finish is Resin Aluminum. For Polished Aluminum, specify Option AP; add \$350.

T-Base & Trestle ‡	w	d	29.9h	Wood Base	Product No.	List \$
• Desk/Bullet: Trestle-TBase 66x30	66.1	30.2		SDB.FLE.A00		3935
Desk/Bullet: Trestle-TBase 72x30	72.1	30.2		SDB.FME.A00		4016
Desk/Bullet: Trestle-TBase 72x36	72.1	36.2		SDB.FMF.A00		4168
Desk/Bullet: Trestle-TBase 78x36	78.1	36.2		SDB.FNF.A00		4302

Trestle columns have a Resin Aluminum finish.  
 Trestle leg finish is Resin Alum. For Polished Aluminum, specify Option AP; add \$32.

T-Base & Oval Leg ‡	w	d	29.9h	Wood Base	Product No.	List \$
Desk/Bullet: Oval-TBase 66x30	66.1	30.2		SDB.JLE.A00		3709
Desk/Bullet: Oval-TBase 72x30	72.1	30.2		SDB.JME.A00		3788
• Desk/Bullet: Oval-TBase 72x36	72.1	36.2		SDB.JMF.A00		3942
Desk/Bullet: Oval-TBase 78x36	78.1	36.2		SDB.JNF.A00		4078

! For use only with bridges or returns.  
 Oval legs have an Resin Aluminum finish.

Desks w. J-Top

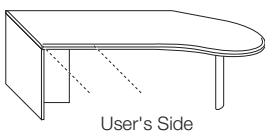
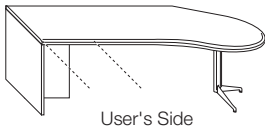

T-Base & Legs ‡	w	d	29.9h	Wood Base	Product No.	List \$
Desk/J: TBase-Trestle 66x30	66.1	36.2		SDC.FLE.A00		4241
Desk/J: TBase-Trestle 72x30	72.1	36.2		SDC.FME.A00		4348
• Desk/J: TBase-Trestle 72x36	72.1	42.2		SDC.FMF.A00		4553
Desk/J: TBase-Trestle 78x36	78.1	42.2		SDC.FNF.A00		4746
Desk/J: Trestle-TBase 66x30	66.1	36.2		SDC.FLE.B00		4241
Desk/J: Trestle-TBase 72x30	72.1	36.2		SDC.FME.B00		4348
Desk/J: Trestle-TBase 72x36	72.1	42.2		SDC.FMF.B00		4553
Desk/J: Trestle-TBase 78x36	78.1	42.2		SDC.FNF.B00		4746

Trestle columns have a Resin Aluminum finish.

T-Base & Oval Leg ‡	w	d	29.9h	Wood Base	Product No.	List \$
Desk/J: TBase-OvalLeg 66x30	66.1	36.2		SDC.JLE.A00		4015
Desk/J: TBase-OvalLeg 72x30	72.1	36.2		SDC.JME.A00		4122
• Desk/J: TBase-OvalLeg 72x36	72.1	42.2		SDC.JMF.A00		4326
Desk/J: TBase-OvalLeg 78x36	78.1	42.2		SDC.JNF.A00		4522
Desk/J: OvalLeg-TBase 66x30	66.1	36.2		SDC.JLE.B00		4015
Desk/J: OvalLeg-TBase 72x30	72.1	36.2		SDC.JME.B00		4122
Desk/J: OvalLeg-TBase 72x36	72.1	42.2		SDC.JMF.B00		4326
Desk/J: OvalLeg-TBase 78x36	78.1	42.2		SDC.JNF.B00		4522

All Desks with J-Top must used with runoffs, bridges, and/or surround panels.

+ Options

T-Base & Trestle leg finish is Resin Alum. For Polished Aluminum, specify Option AP; add \$32.



Specify: Product Number  
 Quantity  
 Tagging  
 Wood Finish  
 Hardware Finish

• Denotes item illustrated  
 ‡ Requires field sub-assembly

Prices listed in Wood1 Finishes.

Runoffs18: Rectangular

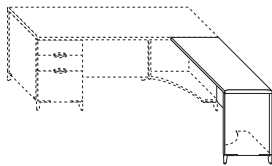
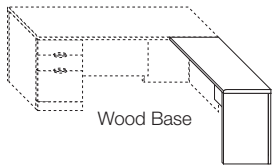
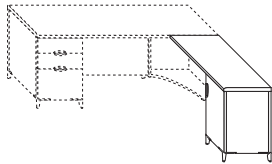
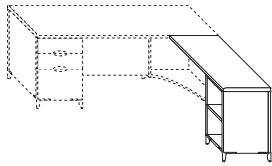

	w	18.1d	29.9h	Wood Base	Foot
Shelving Pedestal					
Runoff18: Shelving LH 42	42.4			SSA.GGC.A00 2287	SSA.HGC.A00 2563
Runoff18: Shelving LH 48	48.4			SSA.GHC.A00 2341	SSA.HHC.A00 2619
Runoff18: Shelving LH 54	54.4			SSA.GJC.A00 2398	SSA.HJC.A00 2674
Runoff18: Shelving LH 84	84.4			SSA.GPC.A00 3012	SSA.HPC.A00 3290
Runoff18: Shelving RH 42	42.4			SSA.GGC.B00 2287	SSA.HGC.B00 2563
Runoff18: Shelving RH 48	48.4			SSA.GHC.B00 2341	SSA.HHC.B00 2619
• Runoff18: Shelving RH 54	54.4			SSA.GJC.B00 2398	SSA.HJC.B00 2674
Runoff18: Shelving RH 84	84.4			SSA.GPC.B00 2678	SSA.HPC.B00 2956

	w	18.1d	29.9h	Wood Base	Foot
Cabinet Pedestal -					
Runoff18: Cabinet LH 42	42.4			SSB.GGC.A00 2426	SSB.HGC.A00 2698
Runoff18: Cabinet LH 48	48.4			SSB.GHC.A00 2480	SSB.HHC.A00 2753
Runoff18: Cabinet LH 54	54.4			SSB.GJC.A00 2565	SSB.HJC.A00 2809
Runoff18: Cabinet LH 84	84.4			SSB.GPC.A00 2819	SSB.HPC.A00 3090
Runoff18: Cabinet RH 42	42.4			SSB.GGC.B00 2426	SSB.HGC.B00 2698
Runoff18: Cabinet RH 48	48.4			SSB.GHC.B00 2480	SSB.HHC.B00 2753
• Runoff18: Cabinet RH 54	54.4			SSB.GJC.B00 2565	SSB.HJC.B00 2809
Runoff18: Cabinet RH 84	84.4			SSB.GPC.B00 2819	SSB.HPC.B00 3090

	w	18.1d	29.9h	Wood Base (L)	Foot (Q)
L/Q-Base ‡					
Runoff18: L/Q-Base LH 42	42.4			SSC.GGC.A00 1693	SSC.HGC.A00 1971
Runoff18: L/Q-Base LH 48	48.4			SSC.GHC.A00 1748	SSC.HHC.A00 2028
Runoff18: L/Q-Base LH 54	54.4			SSC.GJC.A00 1808	SSC.HJC.A00 2087
Runoff18: L/Q-Base LH 84	84.4			SSC.GPC.A00 2090	SSC.HPC.A00 2366
Runoff18: L/Q-Base RH 42	42.4			SSC.GGC.B00 1693	SSC.HGC.B00 1971
Runoff18: L/Q-Base RH 48	48.4			SSC.GHC.B00 1748	SSC.HHC.B00 2028
• Runoff18: L/Q-Base RH 54	54.4			SSC.GJC.B00 1808	SSC.HJC.B00 2087
Runoff18: L/Q-Base RH 84	84.4			SSC.GPC.B00 2090	SSC.HPC.B00 2366

+ Options

Standard modesty panels unfinished backs.  
 For a finished back, change the 8th digit from 0 to 1; add \$118.  
 For a solid color modesty panel, change the 8th digit from 0 to P.  
 For a frosted glass modesty panel, change the 8th digit from 0 to G; add 8%.

Standard foot and pull finish is Resin Aluminum. For Polished Aluminum, specify Option AP:  
 For Polished Aluminum finish on Shelving Pedestal w. Foot, specify Option AP; add \$202.  
 For Polished Aluminum finish on Cabinet Pedestal w. Wood Base, specify Option AP; add \$7.  
 For Polished Aluminum finish on Cabinet Pedestal w. Foot, specify Option AP; add \$210.  
 For Polished Aluminum finish on Q-Base feet, specify Option AP; add \$152.

! Note:

Runoffs shown on this page should not join to tables or desks with Parson's Legs.

Specify: Product Number  
 Quantity  
 Tagging  
 Wood Finish  
 Hardware Finish

• Denotes item illustrated  
 - Includes locks  
 ‡ Requires field sub-assembly

Prices listed in Wood1 Finishes.

Runoffs24: Rectangular

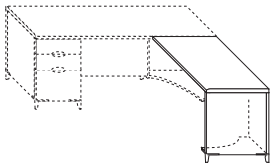
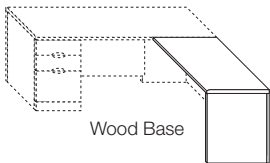
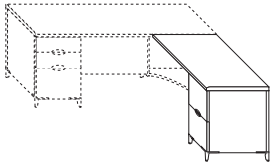
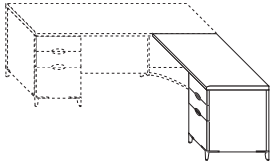

		Product No.	List \$	Product No.	List \$
2BF ↯	w 24.1d 29.9h	Wood Base		Foot	
Runoff24: 2BF LH 42	42.4	SSD.GGD.A00	2755	SSD.HGD.A00	3029
Runoff24: 2BF LH 48	48.4	SSD.GHD.A00	2812	SSD.HHD.A00	3085
Runoff24: 2BF LH 54	54.4	SSD.GJD.A00	2843	SSD.HJD.A00	3140
Runoff24: 2BF RH 42	42.4	SSD.GGD.B00	2755	SSD.HGD.B00	3029
Runoff24: 2BF RH 48	48.4	SSD.GHD.B00	2812	SSD.HHD.B00	3085
• Runoff24: 2BF RH 54	54.4	SSD.GJD.B00	2843	SSD.HJD.B00	3140

		Product No.	List \$	Product No.	List \$
2F ↯	w 24.1d 29.9h	Wood Base		Foot	
Runoff24: 2F LH 42	42.4	SSE.GGD.A00	2755	SSE.HGD.A00	3029
Runoff24: 2F LH 48	48.4	SSE.GHD.A00	2812	SSE.HHD.A00	3085
Runoff24: 2F LH 54	54.4	SSE.GJD.A00	2843	SSE.HJD.A00	3140
Runoff24: 2F RH 42	42.4	SSE.GGD.B00	2755	SSE.HGD.B00	3029
Runoff24: 2F RH 48	48.4	SSE.GHD.B00	2812	SSE.HHD.B00	3085
• Runoff24: 2F RH 54	54.4	SSE.GJD.B00	2843	SSE.HJD.B00	3140

		Product No.	List \$	Product No.	List \$
L/Q-Base ‡	w 24.1d 29.9h	Wood Base(L)		Foot (Q)	
Runoff24: L/Q-Base LH 42	42.4	SSC.GGD.A00	1740	SSC.HGD.A00	2030
Runoff24: L/Q-Base LH 48	48.4	SSC.GHD.A00	1796	SSC.HHD.A00	2089
Runoff24: L/Q-Base LH 54	54.4	SSC.GJD.A00	1851	SSC.HJD.A00	2144
Runoff24: L/Q-Base LH 84	84.4	SSC.GPD.A00	2133	SSC.HPD.A00	2426
Runoff24: L/Q-Base RH 42	42.4	SSC.GGD.B00	1740	SSC.HGD.B00	2030
Runoff24: L/Q-Base RH 48	48.4	SSC.GHD.B00	1796	SSC.HHD.B00	2089
• Runoff24: L/Q-Base RH 54	54.4	SSC.GJD.B00	1851	SSC.HJD.B00	2144
Runoff24: L/Q-Base RH 84	84.4	SSC.GPD.B00	2133	SSC.HPD.B00	2426

+ Options

Standard modesty panels unfinished backs.

For a finished back, change the 8th digit from 0 to 1; add \$118.

For a solid color modesty panel, change the 8th digit from 0 to P.

For a frosted glass modesty panel, change the 8th digit from 0 to G; add 8%.

Standard foot and pull finish is Resin Aluminum. For Polished Aluminum, specify Option AP:

For Polished Aluminum finish on 2BF w. Wood Base, specify Option AP; add \$35.

For Polished Aluminum finish on 2BF w. Foot, specify Option AP; add \$238.

For Polished Aluminum finish on 2F w. Wood Base, specify Option AP; add \$21.

For Polished Aluminum finish on 2F w Foot, specify Option AP; add \$221.

For Polished Aluminum finish on Q-Base feet, specify Option AP; add \$152.

! Note:

Runoffs shown on this page are to be used with Single Pedestal Desks, as illustrated above.

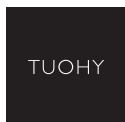

Specify: Product Number  
Quantity  
Tagging  
Wood Finish  
Hardware Finish

• Denotes item illustrated  
↯ Includes locks  
‡ Requires field sub-assembly

Prices listed in Wood1 Finishes.

Runoff24: Rectangular (cont.)

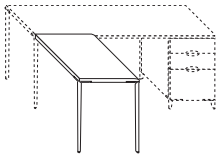

Legs ‡	w	24.1d	29.9h	Open Leg	Product No.	List \$	Product No.	List \$
Runoff24: Legs LH 42	42.4			SSH.CGD.A00		1601		
Runoff24: Legs LH 48	48.4			SSH.CHD.A00		1632		
• Runoff24: Legs LH 54	54.4			SSH.CJD.A00		1661		
Runoff24: Legs LH 60	60.4			SSH.CKD.A00		1689		
Runoff24: Legs LH 66	66.4			SSH.CLD.A00		1719		
Runoff24: Legs LH 72	72.4			SSH.CMD.A00		1747		
Runoff24: Legs RH 42	42.4			SSH.CGD.B00		1601		
Runoff24: Legs RH 48	48.4			SSH.CHD.B00		1632		
Runoff24: Legs RH 54	54.4			SSH.CJD.B00		1661		
Runoff24: Legs RH 60	60.4			SSH.CKD.B00		1689		
Runoff24: Legs RH 66	66.4			SSH.CLD.B00		1719		
Runoff24: Legs RH 72	72.4			SSH.CMD.B00		1747		

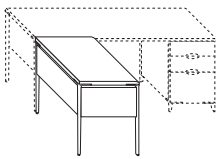

Legs and Modesty Panel ‡	w	24.1d	29.9h	Half Panel	Full Panel
Runoff24: Legs/Panel LH 42	42.4			SSH.DGD.A00	SSH.JGD.A00 2218
Runoff24: Legs/Panel LH 48	48.4			SSH.DHD.A00	SSH.JHD.A00 2272
• Runoff24: Legs/Panel LH 54	54.4			SSH.DJD.A00	SSH.JJD.A00 2329
Runoff24: Legs/Panel LH 60	60.4			SSH.DKD.A00	SSH.JKD.A00 2389
Runoff24: Legs/Panel LH 66	66.4			SSH.DLD.A00	SSH.JLD.A00 2443
Runoff24: Legs/Panel LH 72	72.4			SSH.DMD.A00	SSH.JMD.A00 2500
Runoff24: Legs/Panel RH42	42.4			SSH.DGD.B00	SSH.JGD.B00 2218
Runoff24: Legs/Panel RH48	48.4			SSH.DHD.B00	SSH.JHD.B00 2272
• Runoff24: Legs/Panel RH54	54.4			SSH.DJD.B00	SSH.JJD.B00 2329
Runoff24: Legs/Panel RH60	60.4			SSH.DKD.B00	SSH.JKD.B00 2389
Runoff24: Legs/Panel RH66	66.4			SSH.DLD.B00	SSH.JLD.B00 2443
Runoff24: Legs/Panel RH72	72.4			SSH.DMD.B00	SSH.JMD.B00 2500

Runoffs with Legs and Modesty Panels have three legs and must attach to Desk-Tables w. Parson Legs. Modesty panels on the above units have finished backs.

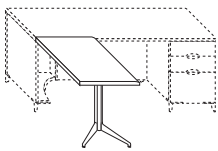
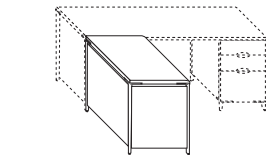

Trestle ‡	w	24.1d	29.9h	Open Leg
Runoff24: Trestle LH 42	42.4			SSH.FGD.A00 1838
Runoff24: Trestle LH 48	48.4			SSH.FHD.A00 1866
• Runoff24: Trestle LH 54	54.4			SSH.FJD.A00 1896
Runoff24: Trestle LH 60	60.4			SSH.FKD.A00 1924
Runoff24: Trestle LH 66	66.4			SSH.FLD.A00 1954
Runoff24: Trestle LH 72	72.4			SSH.FMD.A00 1984
Runoff24: Trestle RH 42	42.4			SSH.FGD.B00 1838
Runoff24: Trestle RH 48	48.4			SSH.FHD.B00 1866
Runoff24: Trestle RH 54	54.4			SSH.FJD.B00 1896
Runoff24: Trestle RH 60	60.4			SSH.FKD.B00 1924
Runoff24: Trestle RH 66	66.4			SSH.FLD.B00 1954
Runoff24: Trestle RH 72	72.4			SSH.FMD.B00 1984

+ Options

Standard parson leg finish is Resin Aluminum. For Polished Aluminum, specify Option AP; add \$350. Standard trestle leg finish is Resin Aluminum. For Polished Aluminum, specify Option AP; add \$33.

Specify: Product Number  
Quantity  
Tagging  
Wood Finish  
Hardware Finish

• Denotes item illustrated  
‡ Requires field sub-assembly

Prices listed in Wood1 Finishes.

Runoff30: Rectangular

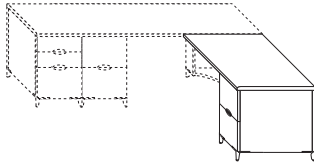
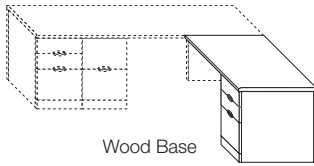

		Product No.	List \$	Product No.	List \$
2BF ↯	w 30.1d 29.9h	Wood Base		Foot	
Runoff30: 2BF LH 48	48.4	SSD.GHE.A00	2945	SSD.HHE.A00	3215
Runoff30: 2BF LH 54	54.4	SSD.GJE.A00	2999	SSD.HJE.A00	3273
Runoff30: 2BF LH 60	60.4	SSD.GKE.A00	3054	SSD.HKE.A00	3328
Runoff30: 2BF LH 66	66.4	SSD.GLE.A00	3111	SSD.HLE.A00	3385
Runoff30: 2BF LH 72	72.4	SSD.GME.A00	3169	SSD.HME.A00	3440
Runoff30: 2BF RH 48	48.4	SSD.GHE.B00	2945	SSD.HHE.B00	3215
• Runoff30: 2BF RH 54	54.4	SSD.GJE.B00	2999	SSD.HJE.B00	3273
Runoff30: 2BF RH 60	60.4	SSD.GKE.B00	3054	SSD.HKE.B00	3328
Runoff30: 2BF RH 66	66.4	SSD.GLE.B00	3111	SSD.HLE.B00	3385
Runoff30: 2BF RH 72	72.4	SSD.GME.B00	3169	SSD.HME.B00	3440

		Product No.	List \$	Product No.	List \$
2F ↯	w 30.1d29.9h	Wood Base		Foot	
Runoff30: 2F LH 48	48.4	SSE.GHE.A00	2945	SSE.HHE.A00	3215
Runoff30: 2F LH 54	54.4	SSE.GJE.A00	2999	SSE.HJE.A00	3273
Runoff30: 2F LH 60	60.4	SSE.GKE.A00	3054	SSE.HKE.A00	3328
Runoff30: 2F LH 66	66.4	SSE.GLE.A00	3111	SSE.HLE.A00	3385
Runoff30: 2F LH 72	72.4	SSE.GME.A00	3169	SSE.HME.A00	3440
Runoff30: 2F RH 48	48.4	SSE.GHE.B00	2945	SSE.HHE.B00	3215
• Runoff30: 2F RH 54	54.4	SSE.GJE.B00	2999	SSE.HJE.B00	3273
Runoff30: 2F RH 60	60.4	SSE.GKE.B00	3054	SSE.HKE.B00	3328
Runoff30: 2F RH 66	66.4	SSE.GLE.B00	3111	SSE.HLE.B00	3385
Runoff30: 2F RH 72	72.4	SSE.GME.B00	3169	SSE.HME.B00	3440

+ Options

Standard modesty panels unfinished backs.

For a finished back, change the 8th digit from 0 to 1; add \$118.

For a solid color modesty panel, change the 8th digit from 0 to P.

For a frosted glass modesty panel, change the 8th digit from 0 to G; add 8%.

Standard foot and pull finish is Resin Aluminum. For Polished Aluminum, specify Option AP:

For Polished Aluminum finish on 2BF w. Wood Base, specify Option AP; add \$35.

For Polished Aluminum finish on 2BF w. Foot, specify Option AP; add \$238.

For Polished Aluminum finish on 2F w. Wood Base, specify Option AP; add \$21.

For Polished Aluminum finish on 2F w. Foot, specify Option AP; add \$221.

! Note:

Runoffs shown on this page should not join to tables or desks with Parson's Legs.



Specify: Product Number  
 Quantity  
 Tagging  
 Wood Finish  
 Hardware Finish

• Denotes item illustrated  
 ↯ Includes locks

Prices listed in Wood1 Finishes.

Runoff30: Rectangular (cont.)

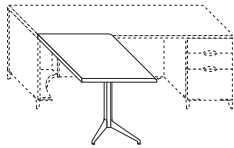
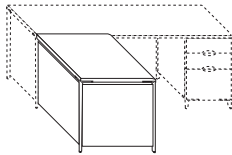
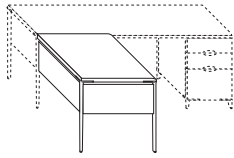
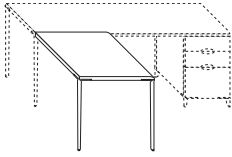

Product No. List \$ Product No. List \$

Legs ‡	w	30.1d	29.9h	Open Leg	
Runoff30: Legs LH 42	42.4			SSH.CGE.A00	1705
Runoff30: Legs LH 48	48.4			SSH.CHE.A00	1735
• Runoff30: Legs LH 54	54.4			SSH.CJE.A00	1763
Runoff30: Legs LH 60	60.4			SSH.CKE.A00	1794
Runoff30: Legs LH 66	66.4			SSH.CLE.A00	1823
Runoff30: Legs LH 72	72.4			SSH.CME.A00	1851
Runoff30: Legs RH 42	42.4			SSH.CGE.B00	1705
Runoff30: Legs RH 48	48.4			SSH.CHE.B00	1735
Runoff30: Legs RH 54	54.4			SSH.CJE.B00	1763
Runoff30: Legs RH 60	60.4			SSH.CKE.B00	1794
Runoff30: Legs RH 66	66.4			SSH.CLE.B00	1823
Runoff30: Legs RH 72	72.4			SSH.CME.B00	1851

Legs and Modesty Panel ‡	w	30.1d	29.9h	Half Panel	Full Panel
Runoff30: Legs/Panel LH 42	42.4			SSH.DGE.A00	2230 SSH.JGE.A00 2322
Runoff30: Legs/Panel LH 48	48.4			SSH.DHE.A00	2277 SSH.JHE.A00 2376
• Runoff30: Legs/Panel LH 54	54.4			SSH.DJE.A00	2326 SSH.JJE.A00 2432
Runoff30: Legs/Panel LH 60	60.4			SSH.DKE.A00	2381 SSH.JKE.A00 2490
Runoff30: Legs/Panel LH 66	66.4			SSH.DLE.A00	2424 SSH.JLE.A00 2546
Runoff30: Legs/Panel LH 72	72.4			SSH.DME.A00	2472 SSH.JME.A00 2602
Runoff30: Legs/Panel RH 42	42.4			SSH.DGE.B00	2230 SSH.JGE.B00 2322
Runoff30: Legs/Panel RH 48	48.4			SSH.DHE.B00	2277 SSH.JHE.B00 2376
Runoff30: Legs/Panel RH 54	54.4			SSH.DJE.B00	2326 SSH.JJE.B00 2432
Runoff30: Legs/Panel RH 60	60.4			SSH.DKE.B00	2381 SSH.JKE.B00 2490
Runoff30: Legs/Panel RH 66	66.4			SSH.DLE.B00	2424 SSH.JLE.B00 2546
Runoff30: Legs/Panel RH 72	72.4			SSH.DME.B00	2472 SSH.JME.B00 2602

Runoffs with Legs and Modesty Panels have three legs and must attach to Desk-Tables w. Parson Legs. Modesty panels on the above units have finished backs.

Trestle ‡	w	30.1d	29.9h	Open Leg	
Runoff30: Trestle LH 42	42.4			SSH.FGE.A00	1939
Runoff30: Trestle LH 48	48.4			SSH.FHE.A00	1969
• Runoff30: Trestle LH 54	54.4			SSH.FJE.A00	1997
Runoff30: Trestle LH 60	60.4			SSH.FKE.A00	2028
Runoff30: Trestle LH 66	66.4			SSH.FLE.A00	2059
Runoff30: Trestle LH 72	72.4			SSH.FME.A00	2089
Runoff30: Trestle RH 42	42.4			SSH.FGE.B00	1939
Runoff30: Trestle RH 48	48.4			SSH.FHE.B00	1969
Runoff30: Trestle RH 54	54.4			SSH.FJE.B00	1997
Runoff30: Trestle RH 60	60.4			SSH.FKE.B00	2028
Runoff30: Trestle RH 66	66.4			SSH.FLE.B00	2059
Runoff30: Trestle RH 72	72.4			SSH.FME.B00	2089

Trestle columns have a Resin Aluminum finish.

+ Options

Standard parson leg finish is Resin Aluminum. For Polished Aluminum, specify Option AP; add \$350. Standard trestle leg finish is Resin Aluminum. For Polished Aluminum, specify Option AP; add \$32.

Specify: Product Number  
Quantity  
Tagging  
Wood Finish  
Hardware Finish

• Denotes item illustrated  
‡ Requires field sub-assembly

Prices listed in Wood1 Finishes.

Runoff30: Bullet-Shape

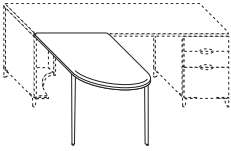

	Product No.	List \$
Parson-Leg ‡	w 30.2d 29.9h	Detail All Sides
Runoff30/Bullet: Leg 48	48.5	SSF.CHE.000 2783
Runoff30/Bullet: Leg 54	54.5	SSF.CJE.000 2862
• Runoff30/Bullet: Leg 60	60.5	SSF.CKE.000 2946
Runoff30/Bullet: Leg 66	66.5	SSF.CLE.000 3025
Runoff30/Bullet: Leg 72	72.5	SSF.CME.000 3105

Standard parson leg finish is Resin Aluminum. For Polished Aluminum, specify Option AP; add \$350.

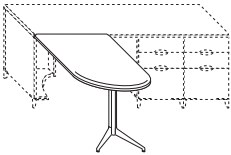

	Product No.	List \$
Trestle ‡	w 30.2d 29.9h	Detail All Sides
Runoff30/Bullet: Trestle 48	48.5	SSF.FHE.000 3018
Runoff30/Bullet: Trestle 54	54.5	SSF.FJE.000 3098
• Runoff30/Bullet: Trestle 60	60.5	SSF.FKE.000 3180
Runoff30/Bullet: Trestle 66	66.5	SSF.FLE.000 3259
Runoff30/Bullet: Trestle 72	72.5	SSF.FME.000 3338

Trestle columns have a Resin Aluminum finish.

Standard trestle leg finish is Resin Aluminum. For Polished Aluminum, specify Option AP; add \$32.

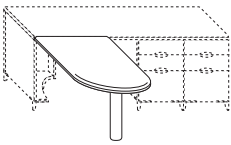

	Product No.	List \$
Oval Leg Base ‡	w 30.2d 29.9h	Detail All Sides
Runoff30/Bullet: Oval Leg 48	48.5	SSF.JHE.000 2792
Runoff30/Bullet: Oval Leg 54	54.5	SSF.JJE.000 2874
• Runoff30/Bullet: Oval Leg 60	60.5	SSF.JKE.000 2954
Runoff30/Bullet: Oval Leg 66	66.5	SSF.JLE.000 3033
Runoff30/Bullet: Oval Leg 72	72.5	SSF.JME.000 3114

Oval leg bases have an Resin Aluminum finish.

Runoff30: J-Bullet Shape

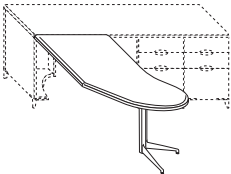

	Product No.	List \$
Trestle ‡	w 36.2d 29.9h	Detail All Sides
• Runoff30/J: Trestle LH 66	66.5	SSG.FLE.A00 3902
Runoff30/J: Trestle LH 72	72.5	SSG.FME.A00 4009
Runoff30/J: Trestle RH 66	66.5	SSG.FLE.B00 3902
Runoff30/J: Trestle RH 72	72.5	SSG.FME.B00 4009

Trestle columns have a Resin Aluminum finish.

Standard trestle leg finish is Resin Aluminum. For Polished Aluminum, specify Option AP; add \$32.

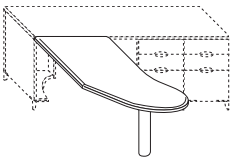

	Product No.	List \$
Oval Leg Base ‡	w 36.2d 29.9h	Detail All Sides
• Runoff30/J: Oval Leg LH 66	66.5	SSG.JLE.A00 3677
Runoff30/J: Oval Leg LH 72	72.5	SSG.JME.A00 3783
Runoff30/J: Oval Leg RH 66	66.5	SSG.JLE.B00 3677
Runoff30/J: Oval Leg RH 72	72.5	SSG.JME.B00 3783

Oval leg bases have an Resin Aluminum finish.



Specify: Product Number  
Quantity  
Tagging  
Wood Finish  
Hardware Finish

• Denotes item illustrated  
‡ Requires field sub-assembly

Prices listed in Wood1 Finishes.

Runoff36: Rectangular

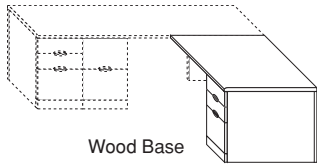

Wood Base

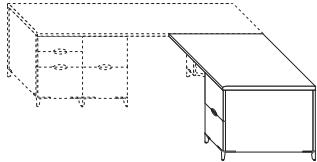

		Product No.	List \$	Product No.	List \$
2BF ↯	w 36.1d 29.9h	Wood Base		Foot	
Runoff36: 2BF LH 48	48.4	SSD.GHF.A00	3439	SSD.HHF.A00	3712
Runoff36: 2BF LH 54	54.4	SSD.GJF.A00	3498	SSD.HJF.A00	3769
Runoff36: 2BF LH 60	60.4	SSD.GKF.A00	3552	SSD.HKF.A00	3826
Runoff36: 2BF LH 66	66.4	SSD.GLF.A00	3609	SSD.HLF.A00	3882
Runoff36: 2BF LH 72	72.4	SSD.GMF.A00	3666	SSD.HMF.A00	3938
Runoff36: 2BF RH 48	48.4	SSD.GHF.B00	3439	SSD.HHF.B00	3712
• Runoff36: 2BF RH 54	54.4	SSD.GJF.B00	3498	SSD.HJF.B00	3769
Runoff36: 2BF RH 60	60.4	SSD.GKF.B00	3552	SSD.HKF.B00	3826
Runoff36: 2BF RH 66	66.4	SSD.GLF.B00	3609	SSD.HLF.B00	3882
Runoff36: 2BF RH 72	72.4	SSD.GMF.B00	3666	SSD.HMF.B00	3938

		Product No.	List \$	Product No.	List \$
2F ↯	w 36.1d 29.9h	Wood Base		Foot	
Runoff36: 2F LH 48	48.4	SSE.GHF.A00	3439	SSE.HHF.A00	3712
Runoff36: 2F LH 54	54.4	SSE.GJF.A00	3498	SSE.HJF.A00	3769
Runoff36: 2F LH 60	60.4	SSE.GKF.A00	3552	SSE.HKF.A00	3826
Runoff36: 2F LH 66	66.4	SSE.GLF.A00	3609	SSE.HLF.A00	3882
Runoff36: 2F LH 72	72.4	SSE.GMF.A00	3666	SSE.HMF.A00	3938
Runoff36: 2F RH 48	48.4	SSE.GHF.B00	3439	SSE.HHF.B00	3712
• Runoff36: 2F RH 54	54.4	SSE.GJF.B00	3498	SSE.HJF.B00	3769
Runoff36: 2F RH 60	60.4	SSE.GKF.B00	3552	SSE.HKF.B00	3826
Runoff36: 2F RH 66	66.4	SSE.GLF.B00	3609	SSE.HLF.B00	3882
Runoff36: 2F RH 72	72.4	SSE.GMF.B00	3666	SSE.HMF.B00	3938

+ Options

Standard modesty panels unfinished backs.

For a finished back, change the 8th digit from 0 to 1; add \$118.

For a solid color modesty panel, change the 8th digit from 0 to P.

For a frosted glass modesty panel, change the 8th digit from 0 to G; add 8%.

Standard foot and pull finish is Resin Aluminum. For Polished Aluminum, specify Option AP:

For Polished Aluminum finish on 2BF w. Wood Base, specify Option AP; add \$35.

For Polished Aluminum finish on 2BF w. Foot, specify Option AP; add \$238.

For Polished Aluminum finish on 2F w. Wood Base, specify Option AP; add \$21.

For Polished Aluminum finish on 2F w. Foot, specify Option AP; add \$221.

! Note:

Runoffs shown on this page should not join to tables or desks with Parson's Legs.

Specify: Product Number  
Quantity  
Tagging  
Wood Finish  
Hardware Finish

• Denotes item illustrated  
↯ Includes locks

Prices listed in Wood1 Finishes.

Runoff36: Rectangular (cont.)

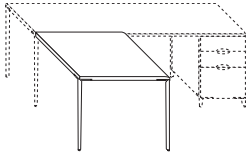

Legs ‡	w	36.1d	29.9h	Open Leg	Product No.	List \$	Product No.	List \$
Runoff36: Legs LH 48	48.4			SSH.CHF.A00	1844			
• Runoff36: Legs LH 54	54.4			SSH.CJF.A00	1874			
Runoff36: Legs LH 60	60.4			SSH.CKF.A00	1903			
Runoff36: Legs LH 66	66.4			SSH.CLF.A00	1934			
Runoff36: Legs LH 72	72.4			SSH.CMF.A00	1964			
Runoff36: Legs RH 48	48.4			SSH.CHF.B00	1844			
Runoff36: Legs RH 54	54.4			SSH.CJF.B00	1874			
Runoff36: Legs RH 60	60.4			SSH.CKF.B00	1903			
Runoff36: Legs RH 66	66.4			SSH.CLF.B00	1934			
Runoff36: Legs RH 72	72.4			SSH.CMF.B00	1964			

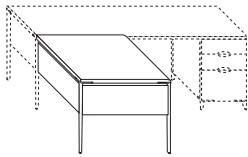

Legs and Modesty Panels ‡	w	36.1d	29.9h	Half Panel	Full Panel		
Runoff36: Legs/Panel LH 48	48.4			SSH.DHF.A00	2391	SSH.JHF.A00	2488
• Runoff36: Legs/Panel LH 54	54.4			SSH.DJF.A00	2438	SSH.JJF.A00	2545
Runoff36: Legs/Panel LH 60	60.4			SSH.DKF.A00	2495	SSH.JKF.A00	2601
Runoff36: Legs/Panel LH 66	66.4			SSH.DLF.A00	2534	SSH.JLF.A00	2656
Runoff36: Legs/Panel LH 72	72.4			SSH.DMF.A00	2583	SSH.JMF.A00	2715
Runoff36: Legs/Panel RH 48	48.4			SSH.DHF.B00	2391	SSH.JHF.B00	2488
Runoff36: Legs/Panel RH 54	54.4			SSH.DJF.B00	2438	SSH.JJF.B00	2545
Runoff36: Legs/Panel RH 60	60.4			SSH.DKF.B00	2495	SSH.JKF.B00	2601
Runoff36: Legs/Panel RH 66	66.4			SSH.DLF.B00	2534	SSH.JLF.B00	2656
Runoff36: Legs/Panel RH 72	72.4			SSH.DMF.B00	2583	SSH.JMF.B00	2715

Runoffs with Legs and Modesty Panels have three legs and must attach to Desk-Tables w. Parson Legs. Modesty panels on the above units have finished backs.

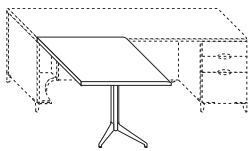

Trestle ‡	w	36.1d	29.9h	Open	
Runoff36: Trestle LH 48	48.4			SSH.FHF.A00	2078
• Runoff36: Trestle LH 54	54.4			SSH.FJF.A00	2112
Runoff36: Trestle LH 60	60.4			SSH.FKF.A00	2140
Runoff36: Trestle LH 66	66.4			SSH.FLF.A00	2169
Runoff36: Trestle LH 72	72.4			SSH.FMF.A00	2199
Runoff36: Trestle RH 48	48.4			SSH.FHF.B00	2078
Runoff36: Trestle RH 54	54.4			SSH.FJF.B00	2112
Runoff36: Trestle RH 60	60.4			SSH.FKF.B00	2140
Runoff36: Trestle RH 66	66.4			SSH.FLF.B00	2169
Runoff36: Trestle RH 72	72.4			SSH.FMF.B00	2199

Trestle columns have a Resin Aluminum finish.

+ Options (all items this page)

Standard parson leg finish is Resin Aluminum. For Polished Aluminum, specify Option AP; add \$350. Standard trestle leg finish is Resin Aluminum. For Polished Aluminum, specify Option AP; add \$32.



Specify: Product Number  
Quantity  
Tagging  
Wood Finish  
Hardware Finish

• Denotes item illustrated  
‡ Requires field sub-assembly

Prices listed in Wood1 Finishes.

Runoff36: Bullet-Shape

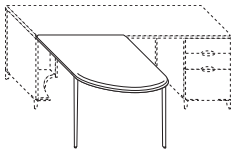

	Product No.	List \$
Parson Leg ‡	w 36.2d 29.9h	Detail All Sides
Runoff36/Bullet: Leg 48	48.5	SSF.CHF.000 2669
Runoff36/Bullet: Leg 54	54.5	SSF.CJF.000 2803
• Runoff36/Bullet: Leg 60	60.5	SSF.CKF.000 2934
Runoff36/Bullet: Leg 66	66.5	SSF.CLF.000 3071
Runoff36/Bullet: Leg 72	72.5	SSF.CMF.000 3205

Standard parson leg finish is Resin Aluminum. For Polished Aluminum, specify Option AP; add \$350.

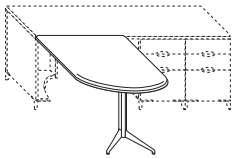

	Product No.	List \$
Trestle ‡	w 36.2d 29.9h	Detail All Sides
Runoff36/Bullet: Trestle 48	48.5	SSF.FHF.000 2903
Runoff36/Bullet: Trestle 54	54.5	SSF.FJF.000 3037
• Runoff36/Bullet: Trestle 60	60.5	SSF.FKF.000 3173
Runoff36/Bullet: Trestle 66	66.5	SSF.FLF.000 3305
Runoff36/Bullet: Trestle 72	72.5	SSF.FMF.000 3439

Trestle columns have a Resin Aluminum finish.  
Standard trestle leg finish is Resin Aluminum. For Polished Aluminum, specify Option AP; add \$32.

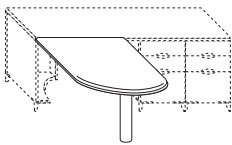

	Product No.	List \$
Oval Leg Base ‡	w 36.2d 29.9h	Detail All Sides
Runoff36/Bullet: Oval Leg 48	48.5	SSF.JHF.000 2870
Runoff36/Bullet: Oval Leg 54	54.5	SSF.JJF.000 3005
• Runoff36/Bullet: Oval Leg 60	60.5	SSF.JKF.000 3137
Runoff36/Bullet: Oval Leg 66	66.5	SSF.JLF.000 3273
Runoff36/Bullet: Oval Leg 72	72.5	SSF.JMF.000 3405

Oval leg bases have an Resin Aluminum finish.

Runoff36: J-Bullet Shape

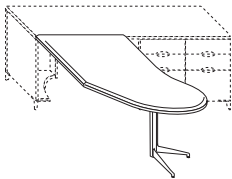

	Product No.	List \$
Trestle ‡	w 42.2d 29.9h	Detail All Sides
• Runoff36/J: Trestle LH 66	66.5	SSG.FLF.A00 3855
Runoff36/J: Trestle LH 72	72.5	SSG.FMF.A00 4048
Runoff36/J: Trestle RH 66	66.5	SSG.FLF.B00 3855
Runoff36/J: Trestle RH 72	72.5	SSG.FMF.B00 4048

Trestle columns have a Resin Aluminum finish.  
Standard trestle leg finish is Resin Aluminum. For Polished Aluminum, specify Option AP; add \$32.

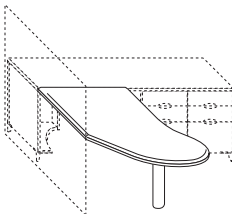

	Product No.	List \$
Oval Leg ‡	w 42.2d 29.9h	Detail All Sides
• Runoff36/J: Oval Leg LH 66	66.5	SSG.JLF.A00 3632
Runoff36/J: Oval Leg LH 72	72.5	SSG.JMF.A00 3825
Runoff36/J: Oval Leg RH 66	66.5	SSG.JLF.B00 3632
Runoff36/J: Oval Leg RH 72	72.5	SSG.JMF.B00 3825

Oval leg bases have an Resin Aluminum finish.

Specify: Product Number  
Quantity  
Tagging  
Wood Finish  
Hardware Finish

• Denotes item illustrated  
‡ Requires field sub-assembly

Prices listed in Wood1 Finishes.

Runoff Tops Only: Rectangular

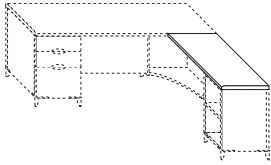

	18 Deep ‡	w 18.1d 1.5th	Top Only	Product No.	List \$
Runoff18: LH 36	36.4			SSH.TFC.A00	1083
Runoff18: LH 42	42.4			SSH.TGC.A00	1111
Runoff18: LH 48	48.4			SSH.THC.A00	1140
Runoff18: LH 54	54.4			SSH.TJC.A00	1170
Runoff18: LH 60	60.4			SSH.TKC.A00	1202
Runoff18: LH 66	66.4			SSH.TLC.A00	1231
Runoff18: LH 72	72.4			SSH.TMC.A00	1260
Runoff18: RH 36	36.4			SSH.TFC.B00	1083
Runoff18: RH42	42.4			SSH.TGC.B00	1111
Runoff18: RH48	48.4			SSH.THC.B00	1140
• Runoff18: RH54	54.4			SSH.TJC.B00	1170
Runoff18: RH60	60.4			SSH.TKC.B00	1202
Runoff18: RH66	66.4			SSH.TLC.B00	1231
Runoff18: RH72	72.4			SSH.TMC.B00	1260

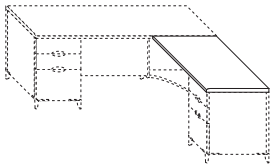

	24 Deep ‡	w 24.1d 1.5th	Top Only	Product No.	List \$
Runoff24: LH 36	36.4			SSH.TFD.A00	1102
Runoff24: LH 42	42.4			SSH.TGD.A00	1131
Runoff24: LH 48	48.4			SSH.THD.A00	1160
Runoff24: LH 54	54.4			SSH.TJD.A00	1190
Runoff24: LH 60	60.4			SSH.TKD.A00	1217
Runoff24: LH 66	66.4			SSH.TLD.A00	1250
Runoff24: LH 72	72.4			SSH.TMD.A00	1279
Runoff24: RH 36	36.4			SSH.TFD.B00	1102
Runoff24: RH42	42.4			SSH.TGD.B00	1131
Runoff24: RH48	48.4			SSH.THD.B00	1160
• Runoff24: RH54	54.4			SSH.TJD.B00	1190
Runoff24: RH60	60.4			SSH.TKD.B00	1217
Runoff24: RH66	66.4			SSH.TLD.B00	1250
Runoff24: RH72	72.4			SSH.TMD.B00	1279

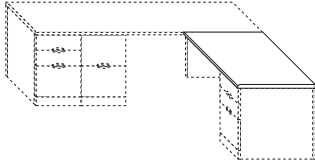

	30 Deep ‡	w 30.1d 1.5th	Top Only	Product No.	List \$
Runoff30:LH 48	48.4			SSH.THE.A00	1265
Runoff30:LH 54	54.4			SSH.TJE.A00	1293
Runoff30:LH 60	60.4			SSH.TKE.A00	1321
Runoff30:LH 66	66.4			SSH.TLE.A00	1352
Runoff30:LH 72	72.4			SSH.TME.A00	1382
Runoff30:RH 48	48.4			SSH.THE.B00	1265
• Runoff30:RH 54	54.4			SSH.TJE.B00	1293
Runoff30:RH 60	60.4			SSH.TKE.B00	1321
Runoff30:RH 66	66.4			SSH.TLE.B00	1352
Runoff30:RH 72	72.4			SSH.TME.B00	1382

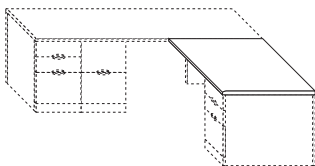

	36 Deep ‡	w 36.1d 1.5th	Top Only	Product No.	List \$
Runoff36:LH 48	48.4			SSH.THF.A00	1377
Runoff36:LH 54	54.4			SSH.TJF.A00	1406
Runoff36:LH 60	60.4			SSH.TKF.A00	1436
Runoff36:LH 66	66.4			SSH.TLF.A00	1464
Runoff36:LH 72	72.4			SSH.TMF.A00	1494
Runoff36:RH 48	48.4			SSH.THF.B00	1377
• Runoff36:RH 54	54.4			SSH.TJF.B00	1406
Runoff36:RH 60	60.4			SSH.TKF.B00	1436
Runoff36:RH 66	66.4			SSH.TLF.B00	1464
Runoff36:RH 72	72.4			SSH.TMF.B00	1494

All tops have flush-cut ends and back.

Specify: Product Number  
Quantity  
Tagging  
Wood Finish  
Hardware Finish

• Denotes item illustrated  
‡ Requires field sub-assembly

Prices listed in Wood1 Finishes.

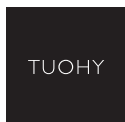

Bridges, Leg-to-Leg Connection

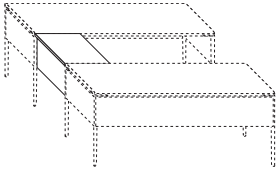

		Product No.	List \$	Product No.	List \$
18 Depth ‡	w 18.1d 29.9h	Half Panel		Full Panel	
Bridge18/ Leg-Leg 30	30.8	SMA.DEC.000	1295	SMA.JEC.000	1295
Bridge18/ Leg-Leg 36	36.8	SMA.DFC.000	1344	SMA.JFC.000	1344
Bridge18/ Leg-Leg 42	42.8	SMA.DGC.000	1392	SMA.JGC.000	1392
Bridge18/ Leg-Leg 50	50.8	SMA.DHC.000	1441	SMA.JHC.000	1441
Bridge18/ Leg-Leg 54	54.8	SMA.DJC.000	1489	SMA.JJC.000	1489
24 Depth ‡	w 24.1d 29.9h	Half Panel		Full Panel	
Bridge24/ Leg-Leg 30	30.8	SMA.DED.000	1316	SMA.JED.000	1316
Bridge24/ Leg-Leg 36	36.8	SMA.DFD.000	1365	SMA.JFD.000	1365
Bridge24/ Leg-Leg 42	42.8	SMA.DGD.000	1412	SMA.JGD.000	1412
• Bridge24/ Leg-Leg 50	50.8	SMA.DHD.000	1462	SMA.JHD.000	1462
Bridge24/ Leg-Leg 54	54.8	SMA.DJD.000	1511	SMA.JJD.000	1511

These bridges attach only to table-deks with parson legs.  
Modesty panels have finished backs on these units.

Bridges, Leg-to-Panel Connection

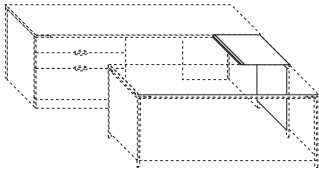

		Full Panel		Foot Attach	
LH Desk Attach 18 Depth ‡	w 18.1d 29.9h				
Bridge18/Leg-Panel 30 LH	30.8	SMA.JEC.0V0	1295	SMA.KEC.0V0	1295
Bridge18/Leg-Panel 36 LH	36.8	SMA.JFC.0V0	1344	SMA.KFC.0V0	1344
Bridge18/Leg-Panel 42 LH	42.8	SMA.JGC.0V0	1392	SMA.KGC.0V0	1392
Bridge18/Leg-Panel 50 LH	50.8	SMA.JHC.0V0	1441	SMA.KHC.0V0	1441
Bridge18/Leg-Panel 54 LH	54.8	SMA.JJC.0V0	1489	SMA.KJC.0V0	1489

		Full Panel		Foot Attach	
LH Desk Attach 24 Depth ‡	w 24.1d 29.9h				
Bridge24/Leg-Panel 30 LH	30.8	SMA.JED.0V0	1316	SMA.KED.0V0	1316
Bridge24/Leg-Panel 36 LH	36.8	SMA.JFD.0V0	1365	SMA.KFD.0V0	1365
Bridge24/Leg-Panel 42 LH	42.8	SMA.JGD.0V0	1412	SMA.KGD.0V0	1412
• Bridge24/Leg-Panel 50 LH	50.8	SMA.JHD.0V0	1462	SMA.KHD.0V0	1462
Bridge24/Leg-Panel 54 LH	54.8	SMA.JJD.0V0	1511	SMA.KJD.0V0	1511

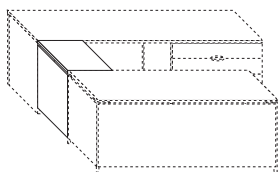

		Full Panel		Foot Attach	
RH Desk Attach 18 Depth ‡	w 18.1d 29.9h				
Bridge18/Leg-Panel 30 RH	30.8	SMA.LEC.0V0	1295	SMA.MEC.0V0	1295
Bridge18/Leg-Panel 36 RH	36.8	SMA.LFC.0V0	1344	SMA.MFC.0V0	1344
Bridge18/Leg-Panel 42 RH	42.8	SMA.LGC.0V0	1392	SMA.MGC.0V0	1392
Bridge18/Leg-Panel 50 RH	50.8	SMA.LHC.0V0	1441	SMA.MHC.0V0	1441
Bridge18/Leg-Panel 54 RH	54.8	SMA.LJC.0V0	1489	SMA.MJC.0V0	1489

		Full Panel		Foot Attach	
RH Desk Attach 24 Depth ‡	w 24.1d 29.9h				
Bridge24/Leg-Panel 30 RH	30.8	SMA.LED.0V0	1316	SMA.MED.0V0	1316
Bridge24/Leg-Panel 36 RH	36.8	SMA.LFD.0V0	1365	SMA.MFD.0V0	1365
Bridge24/Leg-Panel 42 RH	42.8	SMA.LGD.0V0	1412	SMA.MGD.0V0	1412
• Bridge24/Leg-Panel 50 RH	50.8	SMA.LHD.0V0	1462	SMA.MHD.0V0	1462
Bridge24/Leg-Panel 54 RH	54.8	SMA.LJD.0V0	1511	SMA.MJD.0V0	1511

Flush-cut back edge.  
These bridges span parson leg and panel end desks and credenzas.  
Modesty panels have finished backs on these units.

Specify: Product Number  
Quantity  
Tagging  
Wood Finish  
Hardware Finish

• Denotes item illustrated  
‡ Requires field sub-assembly

Prices listed in Wood1 Finishes.

Bridges, Panel-to-Panel Connection

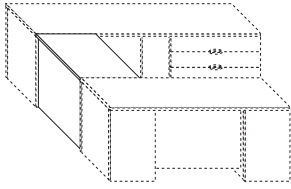

	18 Depth ‡	w	18.1d	29.9h	Product No.	List \$	Product No.	List \$
					Full Panel		Foot Attach	
	Bridge18/Panel-Panel 30	30.8			SMA.GEC.000	1495	SMA.HEC.000	1495
	Bridge18/Panel-Panel 36	36.8			SMA.GFC.000	1579	SMA.HFC.000	1579
	Bridge18/Panel-Panel 42	42.8			SMA.GGC.000	1635	SMA.HGC.000	1635
	Bridge18/Panel-Panel 50	50.8			SMA.GHC.000	1698	SMA.HHC.000	1698
	Bridge18/Panel-Panel 54	54.8			SMA.GJC.000	1753	SMA.HJC.000	1753
	24 Depth ‡	w	24.1d	29.9h	Full Panel		Foot Attach	
	Bridge24/Panel-Panel 30	30.8			SMA.GED.000	1515	SMA.HED.000	1515
	Bridge24/Panel-Panel 36	36.8			SMA.GFD.000	1598	SMA.HFD.000	1598
	Bridge24/Panel-Panel 42	42.8			SMA.GGD.000	1655	SMA.HGD.000	1655
•	Bridge24/Panel-Panel 50	50.8			SMA.GHD.000	1718	SMA.HHD.000	1718
	Bridge24/Panel-Panel 54	54.8			SMA.GJD.000	1773	SMA.HJD.000	1773

Flush-cut back edge.  
These bridges attach to panel end desks and credenzas.

+ Options

Modesty panels have unfinished backs on these units.  
For a finished back, change the 8th digit from 0 to 1; add \$118.  
For a solid color modesty panel, change the 8th digit from 0 to P.

Bridges, Removable Access Panel

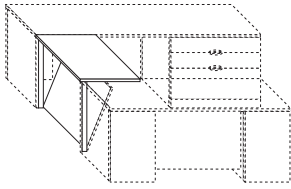

	18 Depth (Unfinished Back) ‡	w	18.1d	29.9h	Product No.	List \$	Product No.	List \$
					Full Panel		Foot Attach	
	Bridge18/Access: 30	30.8			SMB.GEC.000	1569	SMB.HEC.000	1569
	Bridge18/Access: 36	36.8			SMB.GFC.000	1642	SMB.HFC.000	1642
	Bridge18/Access: 42	42.8			SMB.GGC.000	1694	SMB.HGC.000	1694
	Bridge18/Access: 50	50.8			SMB.GHC.000	1751	SMB.HHC.000	1751
	Bridge18/Access: 54	54.8			SMB.GJC.000	1803	SMB.HJC.000	1803
	24 Depth (Unfinished Back) ‡	w	24.1d	29.9h	Full Panel		Foot Attach	
	Bridge24/Access: 30	30.8			SMB.GED.000	1588	SMB.HED.000	1588
	Bridge24/Access: 36	36.8			SMB.GFD.000	1662	SMB.HFD.000	1662
	Bridge24/Access: 42	42.8			SMB.GGD.000	1714	SMB.HGD.000	1714
•	Bridge24/Access: 50	50.8			SMB.GHD.000	1772	SMB.HHD.000	1772
	Bridge24/Access: 54	54.8			SMB.GJD.000	1824	SMB.HJD.000	1824

Flush-cut back edge.

+ Options

Standard modesty panels unfinished backs.  
For a finished back, change the 8th digit from 0 to 1; add \$118.  
For a solid color modesty panel, change the 8th digit from 0 to P.

Bridges, Top Only

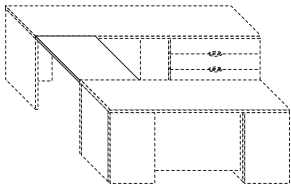

	18 Depth ‡	w	18.1d	1.5th	Product No.	List \$
					Square-Cut Back	
	Bridge18Top: 30	30.8			SMC.OEC.000	1122
	Bridge18Top: 36	36.8			SMC.OFC.000	1154
	Bridge18Top: 42	42.8			SMC.OGC.000	1181
	Bridge18Top: 50	50.8			SMC.OHC.000	1211
	Bridge18Top: 54	54.8			SMC.OJC.000	1240
	24 Depth ‡	w	24.1d	1.5th	Square-Cut Back	
	Bridge24Top: 30	30.8			SMC.OED.000	1141
	Bridge24Top: 36	36.8			SMC.OFD.000	1171
	Bridge24Top: 42	42.8			SMC.OGD.000	1203
•	Bridge24Top: 50	50.8			SMC.OHD.000	1233
	Bridge24Top: 54	54.8			SMC.OJD.000	1262

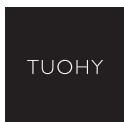

Specify: Product Number  
Quantity  
Tagging  
Wood Finish  
Hardware Finish

• Denotes item illustrated  
‡ Requires field sub-assembly

Prices listed in Wood1 Finishes.

Credenzas—Freestanding

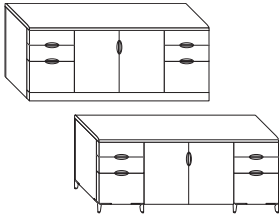

	72w 24.1d 29.9h	Product No.	List \$	Product No.	List \$
Continuous Top -		Wood Base		Foot	
• Credenza: 2BF-DbiCab-2BF		SNA.GMD.000	5626	SNA.HMD.000	5900
Credenza: 2BF-DbiCab-2F		SNB.GMD.000	5626	SNB.HMD.000	5900
Credenza: 2F-DbiCab-2BF		SNC.GMD.000	5626	SNC.HMD.000	5900
Credenza: 2F-DbiCab-2F		SND.GMD.000	5626	SND.HMD.000	5900
Credenza: 2BF-Knee-2BF		SNE.GMD.000	5170	SNE.HMD.000	5444
Credenza: 2BF-Knee-2F		SNF.GMD.000	5170	SNF.HMD.000	5444
Credenza: 2F-Knee-2BF		SNG.GMD.000	5170	SNG.HMD.000	5444
Credenza: 2F-Knee-2F		SNH.GMD.000	5170	SNH.HMD.000	5444
Credenza: 2LatF-2LatF		SNJ.GMD.000	5205	SNJ.HMD.000	5479

Back panels are unfinished.

+ Options

Standard foot and pull finish is Resin Aluminum. For Polished Aluminum, specify Option AP: Aluminum on Wood Base, specify Option AP; add \$93. For Polished Aluminum on Foot Base, specify Option AP; add \$496.

Corner Credenzas

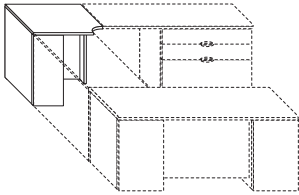

Attach Runoffs/Bridges (a:b) ‡	w	d	29.9h	Wood Base	Foot
CornerCredenza 24:24	36.1	36.1		SNM.GFF.000	1413
CornerCredenza 24:30	36.1	42.1		SNM.GFG.000	1606
CornerCredenza 24:36	36.1	48.1		SNM.GFH.000	1769
CornerCredenza 30:24	42.1	36.1		SNN.GFG.000	1606
CornerCredenza 30:30	42.1	42.1		SNN.GGG.000	1737
CornerCredenza 36:24	48.1	36.1		SNN.GFH.000	1769
CornerCredenza 36:36	48.1	48.1		SNM.GHH.000	2123

Grain direction is long when a and b are not equal.

Grain direction is as shown when a and b are equal.

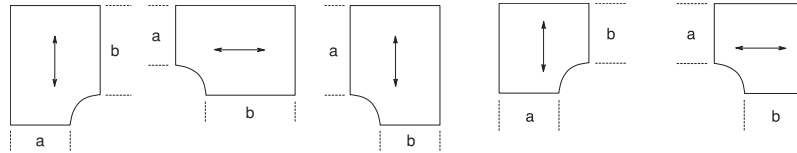

Specify: Product Number  
Quantity  
Tagging  
Wood Finish  
Hardware Finish

• Denotes item illustrated  
‡ Requires field sub-assembly

Prices listed in Wood1 Finishes.

Computer Credenza Top+Base-L

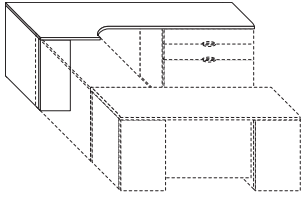

		Product No.	List \$
Base-L is 24x36, Unfinished Back ‡	w 36.1d 29.9h	Detail Front Only	
CredenzaComp24: LH 72	72	SNK.GMF.000	2264
• CredenzaComp24: LH 90	90	SNK.GQF.000	2398
CredenzaComp24: LH 108	108	SNK.GSF.000	2598
CredenzaComp24: RH 72	72	SNL.GMF.000	2264
CredenzaComp24: RH 90	90	SNL.GQF.000	2398
CredenzaComp24: RH 108	108	SNL.GSF.000	2598

Computer Corner Adaptor Top

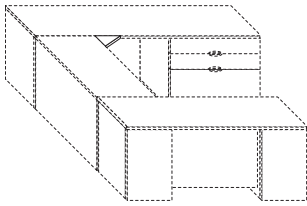

‡	12w 12d 1.5th	Wood1 Finishes	
Computer Corner Adaptor Top		SBD.OAA.000	260

Coped on two sides to mate with edge shapes of perpendicular tops.  
 Specify finish from Tuohy Wood1 Hardwoods and Solid Colors.  
 Inquire regarding hardwood colors or special finishes.



Specify: Product Number  
 Quantity  
 Tagging  
 Wood Finish  
 Hardware Finish

• Denotes item illustrated  
 ‡ Requires field sub-assembly

Prices listed in Wood1 Finishes.

Credenza Tops

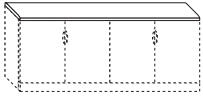

Rectangular 15 Depth ‡	w	15.1d 1.5th	Detail Front Only	List \$	Product No.	List \$	Product No.	List \$
Credenza Top15: 18	18		SPA.CB0.000	828	SPA.CB0.000	899		
Credenza Top15: 30	30		SPA.EB0.000	881	SPB.EB0.000	956		
Credenza Top15: 36	36		SPA.FB0.000	907	SPB.FB0.000	985		
Credenza Top15: 48	48		SPA.HB0.000	957	SPB.HB0.000	1040		
Credenza Top15: 54	54		SPA.JB0.000	984	SPB.JB0.000	1068		
Credenza Top15: 60	60		SPA.KB0.000	1010	SPB.KB0.000	1095		
Credenza Top15: 66	66		SPA.LB0.000	1035	SPB.LB0.000	1126		
• Credenza Top15: 72	72		SPA.MB0.000	1060	SPB.MB0.000	1154		
Credenza Top15: 78	78		SPA.NB0.000	1087	SPB.NB0.000	1181		
Credenza Top15: 84	84		SPA.PB0.000	1111	SPB.PB0.000	1209		
Credenza Top15: 90	90		SPA.QB0.000	1138	SPB.QB0.000	1237		
Credenza Top15: 108	108		SPA.SB0.000	1229	SPB.SB0.000	1335		
Credenza Top15: 120	120		SPA.TB0.000	1286	SPB.TB0.000	1399		

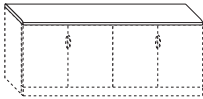

Rectangular 18 Depth ‡	w	18.1d 1.5th	Detail Front Only	List \$	Product No.	List \$	Product No.	List \$
Credenza Top18: 18	18		SPA.CC0.000	878	SPB.CC0.000	953		
Credenza Top18: 30	30		SPA.EC0.000	934	SPB.EC0.000	1016		
Credenza Top18: 36	36		SPA.FC0.000	964	SPB.FC0.000	1051		
Credenza Top18: 48	48		SPA.HC0.000	1025	SPB.HC0.000	1112		
Credenza Top18: 54	54		SPA.JC0.000	1054	SPB.JC0.000	1143		
Credenza Top18: 60	60		SPA.KC0.000	1084	SPB.KC0.000	1178		
Credenza Top18: 66	66		SPA.LC0.000	1111	SPB.LC0.000	1209		
• Credenza Top18: 72	72		SPA.MC0.000	1141	SPB.MC0.000	1241		
Credenza Top18: 78	78		SPA.NC0.000	1170	SPB.NC0.000	1272		
Credenza Top18: 84	84		SPA.PC0.000	1203	SPB.PC0.000	1307		
Credenza Top18: 90	90		SPA.QC0.000	1231	SPB.QC0.000	1339		
Credenza Top18: 108	108		SPA.SC0.000	1342	SPB.SC0.000	1458		
Credenza Top18: 120	120		SPA.TC0.000	1414	SPB.TC0.000	1540		

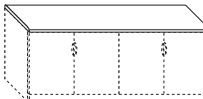

Rectangular 24 Depth ‡	w	24.1d 1.5th	Detail Front Only	List \$	Product No.	List \$	Product No.	List \$
Credenza Top24: 18	18		SPA.CD0.000	893	SPB.CD0.000	975		
Credenza Top24: 24	24		SPA.DD0.000	926	SPB.DD0.000	1005		
Credenza Top24: 30	30		SPA.ED0.000	955	SPB.ED0.000	1038		
Credenza Top24: 36	36		SPA.FD0.000	985	SPB.FD0.000	1069		
Credenza Top24: 48	48		SPA.HD0.000	1042	SPB.HD0.000	1135		
Credenza Top24: 54	54		SPA.JD0.000	1073	SPB.JD0.000	1166		
Credenza Top24: 60	60		SPA.KD0.000	1103	SPB.KD0.000	1201		
Credenza Top24: 66	66		SPA.LD0.000	1131	SPB.LD0.000	1231		
• Credenza Top24: 72	72		SPA.MD0.000	1161	SPB.MD0.000	1263		
Credenza Top24: 78	78		SPA.ND0.000	1190	SPB.ND0.000	1294		
Credenza Top24: 84	84		SPA.PD0.000	1221	SPB.PD0.000	1328		
Credenza Top24: 90	90		SPA.QD0.000	1250	SPB.QD0.000	1358		
Credenza Top24: 108	108		SPA.SD0.000	1407	SPB.SD0.000	1529		
Credenza Top24: 120	120		SPA.TD0.000	1511	SPB.TD0.000	1640		

§ Add 0.1 to depth

Specify: Product Number  
Quantity  
Tagging  
Wood Finish  
Hardware Finish

• Denotes item illustrated  
‡ Requires field sub-assembly

Prices listed in Wood1 Finishes.

TUOHY

Credenza Tops (cont.)

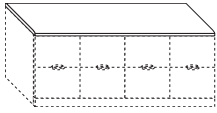

		Product No.	List \$	Product No.	List \$
Rectangular 30 Depth ‡	w 30.1d 1.5th	Detail Front Only	§ Detail Front/Back		
Credenza Top30: 18	18	SPA.CE0.000	998	SPB.CE0.000	1085
Credenza Top30: 30	30	SPA.EE0.000	1058	SPB.EE0.000	1152
Credenza Top30: 36	36	SPA.FE0.000	1087	SPB.FE0.000	1181
Credenza Top30: 48	48	SPA.HE0.000	1145	SPB.HE0.000	1244
Credenza Top30: 54	54	SPA.JE0.000	1177	SPB.JE0.000	1279
Credenza Top30: 60	60	SPA.KE0.000	1206	SPB.KE0.000	1311
Credenza Top30: 66	66	SPA.LE0.000	1236	SPB.LE0.000	1343
• Credenza Top30: 72	72	SPA.ME0.000	1265	SPB.ME0.000	1374
Credenza Top30: 78	78	SPA.NE0.000	1294	SPB.NE0.000	1408
Credenza Top30: 84	84	SPA.PE0.000	1321	SPB.PE0.000	1439
Credenza Top30: 90	90	SPA.QE0.000	1353	SPB.QE0.000	1471
Credenza Top30: 108	108	SPA.SE0.000	1514	SPB.SE0.000	1646
Credenza Top30: 120	120	SPA.TE0.000	1620	SPB.TE0.000	1762

§ Add 0.1 to depth

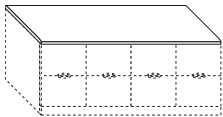

		Product No.	List \$	Product No.	List \$
Rectangular 36 Depth ‡	w 36.1d 1.5th	Detail Front Only	§ Detail Front/Back		
Credenza Top36: 18	18	SPA.CF0.000	1109	SPB.CF0.000	1207
Credenza Top36: 30	30	SPA.EF0.000	1169	SPB.EF0.000	1270
Credenza Top36: 36	36	SPA.FF0.000	1201	SPB.FF0.000	1303
Credenza Top36: 48	48	SPA.HF0.000	1259	SPB.HF0.000	1368
Credenza Top36: 54	54	SPA.JF0.000	1288	SPB.JF0.000	1400
Credenza Top36: 60	60	SPA.KF0.000	1316	SPB.KF0.000	1433
Credenza Top36: 66	66	SPA.LF0.000	1346	SPB.LF0.000	1464
• Credenza Top36: 72	72	SPA.MF0.000	1377	SPB.MF0.000	1495
Credenza Top36: 78	78	SPA.NF0.000	1407	SPB.NF0.000	1529
Credenza Top36: 84	84	SPA.PF0.000	1436	SPB.PF0.000	1560
Credenza Top36: 90	90	SPA.QF0.000	1465	SPB.QF0.000	1593
Credenza Top36: 108	108	SPA.SF0.000	1632	SPB.SF0.000	1772
Credenza Top36: 120	120	SPA.TF0.000	1742	SPB.TF0.000	1894

§ Add 0.1 to depth



Specify: Product Number  
Quantity  
Tagging  
Wood Finish  
Hardware Finish

• Denotes item illustrated  
‡ Requires field sub-assembly

Prices listed in Wood1 Finishes.

Computer Credenza Top

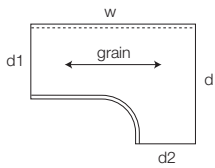
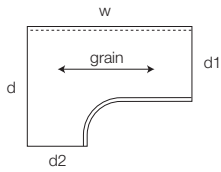

Computer Credenza Top ‡	w	d	d1	d2	Detail Front Only	List \$	Product No.	List \$
Cred Top/Comp 48x48 (24) LH	48	48	24.1	24.1	SAK.THH.JE0	735	SAD.THH.JE0	864
Cred Top/Comp 54x54 (30) LH	54	54	30.1	30.1	SAK.TJJ.FF0	813	SAD.TJJ.FF0	945
Cred Top/Comp 66x42 (18) LH	66	42	24.1	18.1	SAK.TLG.DC0	1541	SAD.TLG.DC0	1809
Cred Top/Comp 72x42 (24) LH	72	42	24.1	24.1	SAK.TMG.DD0	1595	SAD.TMG.DD0	1864
Cred Top/Comp 78x42 (18) LH	78	42	24.1	18.1	SAK.TNG.DC0	1649	SAD.TNG.DC0	1918
Cred Top/Comp 78x42 (24) LH	78	42	24.1	24.1	SAK.TNG.DD0	1649	SAD.TNG.DD0	1918
Cred Top/Comp 66x48 (18) LH	66	48	30.1	18.1	SAK.TLH.EC0	1706	SAD.TLH.EC0	1971
Cred Top/Comp 66x48 (24) LH	66	48	30.1	24.1	SAK.TLH.JD0	1706	SAD.TLH.JD0	1971
Cred Top/Comp 72x48 (18) LH	72	48	30.1	18.1	SAK.TMH.JC0	1760	SAD.TMH.JC0	2026
Cred Top/Comp 72x48 (24) LH	72	48	30.1	24.1	SAK.TMH.JD0	1760	SAD.TMH.JD0	2026
Cred Top/Comp 78x48 (18) LH	78	48	30.1	18.1	SAK.TNH.EC0	1814	SAD.TNH.EC0	2081
Cred Top/Comp 78x48 (24) LH	78	48	30.1	24.1	SAK.TNH.ED0	1814	SAD.TNH.ED0	2081
Cred Top/Comp 72x54 (24) LH	72	54	36.1	24.1	SAK.TLJ.FD0	1869	SAD.TLJ.FD0	2138
Cred Top/Comp 78x54 (24) LH	78	54	36.1	24.1	SAK.TNJ.FD0	1924	SAD.TNJ.FD0	2192

Computer Credenza Top ‡	w	d	d1	d2	Detail Front Only	List \$	Product No.	List \$
Cred Top/Comp 48x48 (24) RH	48	48	24.1	24.1	SAL.THH.JE0	750	SAE.THH.JE0	884
Cred Top/Comp 54x54 (30) RH	54	54	30.1	30.1	SAL.TJJ.FF0	829	SAE.TJJ.FF0	963
Cred Top/Comp 66x42 (18) RH	66	42	24.1	18.1	SAL.TLG.DC0	1541	SAE.TLG.DC0	1809
Cred Top/Comp 72x42 (24) RH	72	42	24.1	24.1	SAL.TMG.DD0	1595	SAE.TMG.DD0	1864
Cred Top/Comp 78x42 (18) RH	78	42	24.1	18.1	SAL.TNG.DC0	1649	SAE.TNG.DC0	1918
Cred Top/Comp 78x42 (24) RH	78	42	24.1	24.1	SAL.TNG.DD0	1649	SAE.TNG.DD0	1918
Cred Top/Comp 66x48 (18) RH	66	48	30.1	18.1	SAL.TLH.EC0	1706	SAE.TLH.EC0	1971
Cred Top/Comp 66x48 (24) RH	66	48	30.1	24.1	SAL.TLH.JD0	1706	SAE.TLH.JD0	1971
Cred Top/Comp 72x48 (18) RH	72	48	30.1	18.1	SAL.TMH.JC0	1760	SAE.TMH.JC0	2026
Cred Top/Comp 72x48 (24) RH	72	48	30.1	24.1	SAL.TMH.JD0	1760	SAE.TMH.JD0	2026
Cred Top/Comp 78x48 (18) RH	78	48	30.1	18.1	SAL.TNH.EC0	1814	SAE.TNH.EC0	2081
Cred Top/Comp 78x48 (24) RH	78	48	30.1	24.1	SAL.TNH.ED0	1814	SAE.TNH.ED0	2081
Cred Top/Comp 72x54 (24) RH	72	54	36.1	24.1	SAL.TLJ.FD0	1869	SAE.TLJ.FD0	2138
Cred Top/Comp 78x54 (24) RH	78	54	36.1	24.1	SAL.TNJ.FD0	1924	SAE.TNJ.FD0	2192

§ Add 0.1 to d1

May be joined to other desk-tables, credenzas or credenza tops; not for use with bridges or runoffs.  
d, d1, and d2 always have flush cut edges.

w is flush cut on Detail Front Only, and has a detail on Detail Front/Back.

The user's edge (with computer corner) always has a detail.

Specify: Product Number  
Quantity  
Tagging  
Wood Finish  
Hardware Finish

• Denotes item illustrated  
‡ Requires field sub-assembly

Prices listed in Wood1 Finishes.

TUOHY

Credenza Tops: Elbow (120)

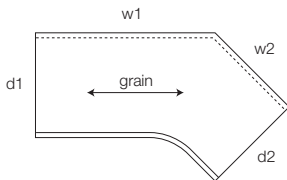
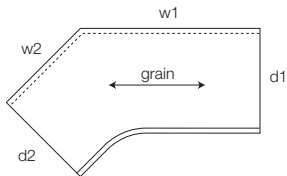
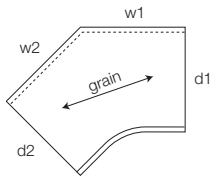

Top Support Keels

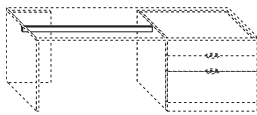

Elbow (120) Shape ‡	w1	w2	d1	d2	Detail Front Only	List \$	Product No.	List \$	Product No.	List \$
Credenza Top/Elbow 42/24	42	42	24.1	24.1	SAM.TGG.DD0	1874	SAF.TGG.DD0	2074		
Credenza Top/Elbow 42/30	42	42	30.1	30.1	SAM.TGG.JJ0	1929	SAF.TGG.JJ0	2129		
Credenza Top/Elbow 48/24	48	48	24.1	24.1	SAM.THH.DD0	1985	SAF.THH.DD0	2187		
Credenza Top/Elbow 48/24-30	48	48	24.1	30.1	SAM.THH.DE0	2039	SAF.THH.DE0	2239		
Credenza Top/Elbow 48/30-24	48	48	30.1	24.1	SAM.THH.ED0	2039	SAF.THH.ED0	2239		
Credenza Top/Elbow 48/30	48	48	30.1	30.1	SAM.THH.EE0	2039	SAF.THH.EE0	2239		

Grain direction on units above is diagonal.

Elbow (120) Shape LH ‡	w1	w2	d1	d2	Detail Front Only	List \$	Product No.	List \$	Product No.	List \$
Credenza Top/Elbow 72/24 LH	72	42	24.1	24.1	SAN.TMG.DD0	2236	SAG.TMG.DD0	2437		
Credenza Top/Elbow 72/30 LH	72	42	30.1	30.1	SAN.TMG.EE0	2329	SAG.TMG.EE0	2531		
Credenza Top/Elbow 78/24 LH	78	42	24.1	24.1	SAN.TNG.DD0	2370	SAG.TNG.DD0	2571		
Credenza Top/Elbow 78/30 LH	78	42	30.1	30.1	SAN.TNG.EE0	2465	SAG.TNG.EE0	2666		

Elbow (120) Shape RH ‡	w1	w2	d1	d2	Detail Front Only	List \$	Product No.	List \$	Product No.	List \$
Credenza Top/Elbow 72/24 RH	72	42	24.1	24.1	SAP.TMG.DD0	2236	SAH.TMG.DD0	2437		
Credenza Top/Elbow 72/30 RH	72	42	30.1	30.1	SAP.TMG.EE0	2329	SAH.TMG.EE0	2531		
Credenza Top/Elbow 78/24 RH	78	42	24.1	24.1	SAP.TNG.DD0	2370	SAH.TNG.DD0	2571		
Credenza Top/Elbow 78/30 RH	78	42	30.1	30.1	SAP.TNG.EE0	2465	SAH.TNG.EE0	2666		

Grain direction is along the w1 dimension, except as noted above.

§ Add 0.1 to d1, d2

‡	w	2d	1h	Black Resin Finish
Top Support Keel: 52	52			LG-52 236
Top Support Keel: 58	58			LG-58 243
Top Support Keel: 64	64			LG-64 246
Top Support Keel: 70	70			LG-70 250
Top Support Keel: 82	82			LG-82 255
• Top Support Keel: 88	88			LG-88 260

! Notes:

Required for unsupported work surface spans of 54 inches or more.  
 Unit is a black rectangular 1 x 2 tube screwed to the underside of the work surface.



Specify: Product Number  
 Quantity  
 Tagging  
 Wood Finish  
 Hardware Finish

• Denotes item illustrated  
 ‡ Requires field sub-assembly

Prices listed in Wood1 Finishes.

Bases		Product No.	List \$
Use with Credenza and Runoff Tops ‡ w d 28.4h			
1	Post-Leg Diam (pair)	3 2	SQA.A00.000 638
2	Post-Leg w.Caster (pair)	3 2	SQA.B00.000 755
3	Oval Leg	6 3.5	SQA.J00.000 480
4	Trestle2-19	19.5 10	SQA.F00.000 706
	Trestle2-25	26.3 13.3	SQA.N00.000 733
5	Trestle2-19 w. Caster	19.5 10	SQA.L00.000 823
	Trestle2-25 w. Caster	26.3 13.3	SQA.Q00.000 852
6	Trestle4-19	19.5 18	SQA.K00.000 1082
	Trestle4-25	26.3 24.6	SQA.P00.000 1137
7	Trestle4-19 w. Caster	19.5 18	SQA.M00.000 1315
	Trestle4-25 w. Caster	26.3 24.6	SQA.R00.000 1371

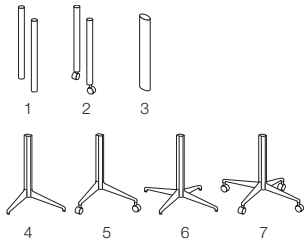

All bases have wire management.  
All vertical columns are Resin Aluminum.  
Trestle legs are cast aluminum with a Satin Aluminum Resin finish.

+ Options

For Trestle bases with 2 Polished Aluminum legs, specify Option AP, add \$32.  
For Trestle bases with 4 Polished Aluminum legs, specify Option AP, add \$66.

Base Q-Panels		Base-Q LH ‡	w	d	28.4h	Unfinished Back
		Base-Q15: LH 18	18	15		SQB.HCB.000 655
		Base-Q15: LH 24	24	15		SQB.HDB.000 677
		Base-Q18: LH 18	18	18		SQB.HCC.000 670
		Base-Q18: LH 24	24	18		SQB.HDC.000 697
1		Base-Q24: LH 18	18	24		SQB.HCD.000 705
		Base-Q24: LH 24	24	24		SQB.HDD.000 753
		Base-Q30: LH 18	18	30		SQB.HCE.000 759
		Base-Q30: LH 24	24	30		SQB.HDE.000 811
		Base-Q36: LH 18	18	36		SQB.HCF.000 817
		Base-Q36: LH 24	24	36		SQB.HDF.000 867

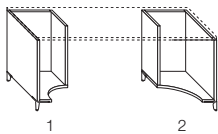

		Base-Q RH ‡	w	d	28.4h	Unfinished Back
		Base-Q15: RH 18	18	15		SQC.HCB.000 655
		Base-Q15: RH 24	24	15		SQC.HDB.000 677
		Base-Q18: RH 18	18	18		SQC.HCC.000 670
		Base-Q18: RH 24	24	18		SQC.HDC.000 697
2		Base-Q24: RH 18	18	24		SQC.HCD.000 705
		Base-Q24: RH 24	24	24		SQC.HDD.000 753
		Base-Q30: RH 18	18	30		SQC.HCE.000 759
		Base-Q30: RH 24	24	30		SQC.HDE.000 811
		Base-Q36: RH 18	18	36		SQC.HCF.000 817
		Base-Q36: RH 24	24	36		SQC.HDF.000 867

+ Options

Bases are standard with veneer.  
For a unit with finished back, change the 8th digit from 0 to 1; add \$118.  
For a solid color finish, change the last digit to 1.  
Standard foot finish is Resin Aluminum. For Polished Aluminum, specify Option AP; add \$152.

Specify: Product Number  
Quantity  
Tagging  
Wood Finish  
Hardware Finish

• Denotes item illustrated  
‡ Requires field sub-assembly

Prices listed in Wood1 Finishes.

Base L/T/I Panels

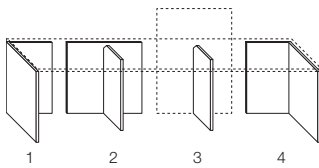

		w	d	28.4h	Product No.	List \$
	Base-L LH ‡				Unfinished Back	
	Base-L15: LH 18	18	15		SQD.GCB.000	383
	Base-L15: LH 24	24	15		SQD.GDB.000	398
	Base-L18: LH 18	18	18		SQD.GCC.000	393
	Base-L18: LH 24	24	18		SQD.GDC.000	412
1	Base-L24: LH 18	18	24		SQD.GCD.000	412
	Base-L24: LH 24	24	24		SQD.GDD.000	456
	Base-L30: LH 18	18	30		SQD.GCE.000	456
	Base-L30: LH 24	24	30		SQD.GDE.000	500
	Base-L36: LH 18	18	36		SQD.GCF.000	500
	Base-L36: LH 24	24	36		SQD.GDF.000	545

		w	d	28.4h	Product No.	List \$
	Base-L RH ‡				Unfinished Back	
	Base-L15: RH 18	18	15		SQE.GCB.000	383
	Base-L15: RH 24	24	15		SQE.GDB.000	398
	Base-L18: RH 18	18	18		SQE.GCC.000	393
	Base-L18: RH 24	24	18		SQE.GDC.000	412
4	Base-L24: RH 18	18	24		SQE.GCD.000	412
	Base-L24: RH 24	24	24		SQE.GDD.000	456
	Base-L30: RH 18	18	30		SQE.GCE.000	456
	Base-L30: RH 24	24	30		SQE.GDE.000	500
	Base-L36: RH 18	18	36		SQE.GCF.000	500
	Base-L36: RH 24	24	36		SQE.GDF.000	545

		w	d	28.4h	Product No.	List \$
	Base-T & Base-I ‡				Unfinished Back	
	Base-T9: 18	18	9		SQF.GC9.000	436
2	Base-T9: 36	36	9		SQF.GF9.000	500
	Base-T18: 30	30	18		SQF.GEC.000	456
	Base-T18: 36	36	18		SQF.GFC.000	623
3	Base-I 9	1	9		SQG.G90.000	232
	Base-I 15	1	15		SQG.GB0.000	254
	Base-I 24	1	24		SQG.GD0.000	285

+ Options

Bases are standard with veneer.  
For a unit with finished back, change the 8th digit from 0 to 1; add \$118.  
For a solid color finish, change the last digit to 1.

Modesty Panels

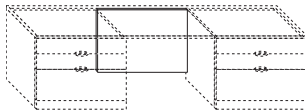

		w	1d	25.0h	Product No.	List \$
	Fixed (No toeboard) ‡				Unfinished Back	
	Modesty-Panel: 18	18			SUA.C00.000	363
	Modesty-Panel: 24	24			SUA.D00.000	386
	Modesty-Panel: 30	30			SUA.E00.000	409
•	Modesty-Panel: 36	36			SUA.F00.000	433
	Modesty-Panel: 42	42			SUA.G00.000	451
	Modesty-Panel: 48	48			SUA.H00.000	478
	Modesty-Panel: 54	54			SUA.J00.000	501
	Modesty-Panel: 72	72			SUA.M00.000	570

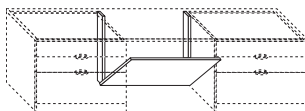

		w	3d	23.5h	Product No.	List \$
	Access/Removable (1.5 gap at top) ‡				Unfinished Back	
	Modesty-Access: 18	18			SUB.C00.000	451
	Modesty-Access: 24	24			SUB.D00.000	474
	Modesty-Access: 30	30			SUB.E00.000	497
•	Modesty-Access: 36	36			SUB.F00.000	518
	Modesty-Access: 42	42			SUB.G00.000	544
	Modesty-Access: 48	48			SUB.H00.000	569
	Modesty-Access: 54	54			SUB.J00.000	589
	Modesty-Access: 72	72			SUB.M00.000	656

+ Options

Modesty Panels are standard with veneer.  
For a finished back, change the 8th digit from 0 to 1; add \$118.  
For a solid color modesty panel, change the 8th digit from 0 to P.



Specify: Product Number  
Quantity  
Tagging  
Wood Finish  
Hardware Finish

• Denotes item illustrated  
‡ Requires field sub-assembly

Prices listed in Wood1 Finishes.

Pedestals w. Foot

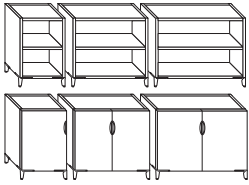

	Product No.	List \$
15 Deep Shelving and Cabinets ~ w 15d 28.4h	Unfinished Back	
Ped15/Foot: Shelving 18	18	SRA.HCB.000 1084
Ped15/Foot: Shelving 30	30	SRA.HEB.000 1320
Ped15/Foot: Shelving 36	36	SRA.HFB.000 1446
Ped15/Foot: Cabinet LH 18 *	18	SRB.HCB.000 1434
Ped15/Foot: Cabinet RH 18 *	18	SRC.HCB.000 1434
Ped15/Foot: DbuCabinet 30	30	SRD.HEB.000 1600
Ped15/Foot: DbuCabinet 36	36	SRD.HFB.000 1726

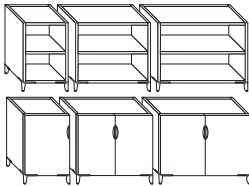

	Product No.	List \$
18 Deep Shelving and Cabinets ~ w 18d 28.4h	Unfinished Back	
Ped18/Foot: Shelving 18	18	SRA.HCC.000 1128
Ped18/Foot: Shelving 30	30	SRA.HEC.000 1380
Ped18/Foot: Shelving 36	36	SRA.HFC.000 1513
Ped18/Foot: Cabinet LH 18 *	18	SRB.HCC.000 1489
Ped18/Foot: Cabinet RH 18 *	18	SRC.HCC.000 1489
Ped18/Foot: DbuCabinet 30	30	SRD.HEC.000 1666
Ped18/Foot: DbuCabinet 36	36	SRD.HFC.000 1799

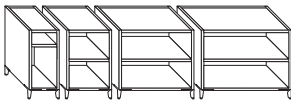

	Product No.	List \$
24 Deep Shelving w 24d 28.4h	Unfinished Back	
Ped24/Foot: ShelvingPC 12	12	SRA.HAD.000 1070
Ped24/Foot: Shelving 18	18	SRA.HCD.000 1237
Ped24/Foot: Shelving 30	30	SRA.HED.000 1505
Ped24/Foot: Shelving 36	36	SRA.HFD.000 1632

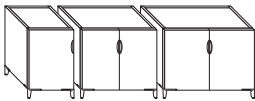

	Product No.	List \$
24 Deep Cabinets ~ w 24d 28.4h	Unfinished Back	
Ped24/Foot: Cabinet LH 18 *	18	SRB.HCD.000 1572
Ped24/Foot: Cabinet RH 18 *	18	SRC.HCD.000 1572
Ped24/Foot: DbuCabinet 30	30	SRD.HED.000 1710
Ped24/Foot: DbuCabinet 36	36	SRD.HFD.000 1811

Standard foot and pull finish is Resin Aluminum. For Polished Aluminum, specify Option AP:  
For Polished Aluminum on Shelving feet, specify Option AP; add \$202.  
For Polished Aluminum on Cabinet feet and pulls, specify Option AP; add \$221.



	Product No.	List \$
24 Deep Files ~ w 24d 28.4h	Unfinished Back	
Ped24/Foot: 2F 18	18	SRF.HCD.000 1851
Ped24/Foot: 2LatF 30	30	SRG.HED.000 2160
Ped24/Foot: 2LatF 36	36	SRG.HFD.000 2349



	Product No.	List \$
24 Deep Box-Files ~ w 24d 28.4h	Unfinished Back	
Ped24/Foot: 2BF 18	18	SRH.HCD.000 1851
Ped24/Foot: 2LatB/LatF 30	30	SRJ.HED.000 2336
Ped24/Foot: 2LatB/LatF 36	36	SRJ.HFD.000 2517

Locks are included.  
Standard foot and pull finish is Resin Aluminum.  
For Polished Aluminum on File feet and pulls, specify Option AP; add \$229.

! Important:

Single door cabinet pedestals should be used where side access to the pull is available.  
In situations where side access to the pull hardware is limited or not available, specify Optional Cabinet Pull.



Specify: Product Number  
Quantity  
Tagging  
Wood Finish  
Hardware Finish

• Denotes item illustrated  
‡ Requires field sub-assembly

Prices listed in Wood1 Finishes.

Pedestals w. Foot (cont.)

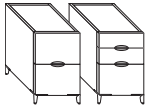
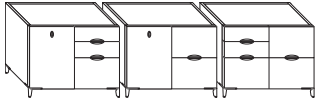
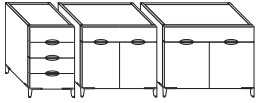

		Product No.	List \$
24 Deep 4-Box and Box-Cabinet †	w 24d 28.4h	Unfinished Back	
Ped24/Foot: 4B 18	18	SRK.HCD.000	1918
Ped24/Foot: LatB/DbiCab 30	30	SRL.HED.000	2229
Ped24/Foot: LatB/DbiCab 36	36	SRL.HFD.000	2410

24 Deep Cabinet-Drawers †	36w 24d 28.4h	Unfinished Back	
• Ped24/Foot: Cabinet-2BF 36		SRM.HFD.000	3067
Ped24/Foot: 2BF-Cabinet 36		SRN.HFD.000	3067
• Ped24/Foot: Cabinet-2F 36		SRP.HFD.000	3067
Ped24/Foot: 2F-Cabinet 36		SRQ.HFD.000	3067
• Ped24/Foot: 2BF-2F 36		SRR.HFD.000	3304
Ped24/Foot: 2F-2BF 36		SRS.HFD.000	3304

30 Deep Drawer Pedestals †	18w 30d 28.4h	Unfinished Back	
Ped30/Foot: 2F 18		SRF.HCE.000	1883
Ped30/Foot: 2BF 18		SRH.HCE.000	1883

36 Deep Drawer Pedestals †	18w 36d 28.4h	Unfinished Back	
Ped36/Foot: 2F 18		SRF.HCF.000	2268
Ped36/Foot: 2BF 18		SRH.HCF.000	2268

Locks are included.

+ Options (all items on this, opposite and next pages)

- Pedestals are standard with veneer.
- For a unit with finished back, change the 8th digit from 0 to 1; add \$118.
- For a Wood1 Solid Color finish, change the last digit to 1.
- For a veneer unit with solid color drawer faces, change the last digit to 4.
- For a solid color unit with veneer drawer faces, change the last digit to 5.

Standard foot and pull finish is Resin Aluminum.  
 For Polished Aluminum on Pedestal feet and pulls, specify Option AP; add \$238.

Specify: Product Number  
 Quantity  
 Tagging  
 Wood Finish  
 Hardware Finish

- Denotes item illustrated
- ‡ Requires field sub-assembly

Prices listed in Wood1 Finishes.



Pedestals w. Wood Base

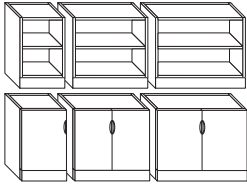

		Product No.	List \$
15 Deep Shelving and Cabinets ↵	w 15d 28.4h	Unfinished Back	
Ped15: Shelving 18	18	SRA.GCB.000	810
Ped15: Shelving 30	30	SRA.GEB.000	1051
Ped15: Shelving 36	36	SRA.GFB.000	1176
Ped15: Cabinet LH 18 *	18	SRB.GCB.000	1160
Ped15: Cabinet RH 18 *	18	SRC.GCB.000	1160
Ped15: DblCabinet 30	30	SRD.GEB.000	1330
Ped15: DblCabinet 36	36	SRD.GFB.000	1456

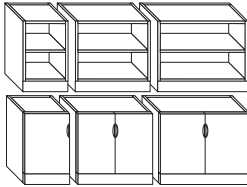

		Product No.	List \$
18 Deep Shelving and Cabinets ↵	w 18d 28.4h	Unfinished Back	
Ped18: Shelving 18	18	SRA.GCC.000	856
Ped18: Shelving 30	30	SRA.GEC.000	1108
Ped18: Shelving 36	36	SRA.GFC.000	1239
Ped18: Cabinet LH 18 *	18	SRB.GCC.000	1215
Ped18: Cabinet RH 18 *	18	SRC.GCC.000	1215
Ped18: DblCabinet 30	30	SRD.GEC.000	1394
Ped18: DblCabinet 36	36	SRD.GFC.000	1527

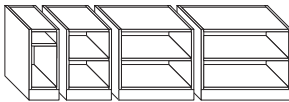

		Product No.	List \$
24 Deep Shelving	w 24d 28.4h	Unfinished Back	
Ped24: ShelvingPC 12	12	SRA.GAD.000	799
Ped24: Shelving 18	18	SRA.GCD.000	964
Ped24: Shelving 30	30	SRA.GED.000	1233
Ped24: Shelving 36	36	SRA.GFD.000	1357

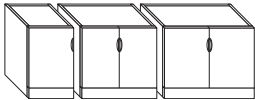

		Product No.	List \$
24 Deep Cabinets ↵	w 24d 28.4h	Unfinished Back	
Ped24: Cabinet LH 18 *	18	SRB.GCD.000	1301
Ped24: Cabinet RH 18 *	18	SRC.GCD.000	1301
Ped24: DblCabinet 30	30	SRD.GED.000	1438
Ped24: DblCabinet 36	36	SRD.GFD.000	1539



		Product No.	List \$
24 Deep Files ↵	w 24d 28.4h	Unfinished Back	
Ped24: 2F 18	18	SRF.GCD.000	1580
Ped24: 2LatF 30	30	SRG.GED.000	1888
Ped24: 2LatF 36	36	SRG.GFD.000	2076

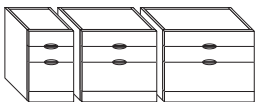

		Product No.	List \$
24 Deep Box-Files ↵	w 24d 28.4h	Unfinished Back	
Ped24: 2BF 18	18	SRH.GCD.000	1580
Ped24: 2LatB/LatF 30	30	SRJ.GED.000	2062
Ped24: 2LatB/LatF 36	36	SRJ.GFD.000	2244

Locks are included where applicable.  
Standard pull finish is Resin Aluminum.  
For Polished Aluminum on pulls, specify Option AP; add \$21.

\*See the note on a previous page regarding an optional pull selection for single cabinet doors.

Specify: Product Number  
Quantity  
Tagging  
Wood Finish  
Hardware Finish

• Denotes item illustrated  
‡ Requires field sub-assembly

Prices listed in Wood1 Finishes.

Pedestals w. Wood Base (cont.)

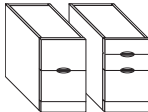
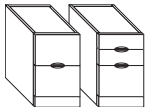
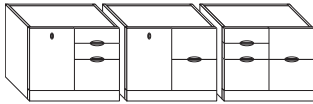
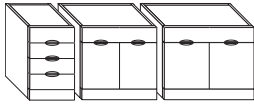

	Product No.	List \$
24 Deep 4-Box and Box-Cabinet † w 24d 28.4h Unfinished Back		
Ped24: 4B 18	SRK.GCD.000	1646
Ped24: LatB/DblCab 30	SRL.GED.000	1956
Ped24: LatB/DblCab 36	SRL.GFD.000	2140

	Product No.	List \$
24 Deep Cabinet-Drawers † 36w 24d 28.4h Unfinished Back		
• Ped24: Cabinet-2BF 36	SRM.GFD.000	2793
Ped24: 2BF-Cabinet 36	SRN.GFD.000	2793
• Ped24: Cabinet-2F 36	SRP.GFD.000	2793
Ped24: 2F-Cabinet 36	SRQ.GFD.000	2793
• Ped24: 2BF-2F 36	SRR.GFD.000	3032
Ped24: 2F-2BF 36	SRS.GFD.000	3032

	Product No.	List \$
30 Deep Drawer Pedestals † 18w 30d 28.4h Unfinished Back		
Ped30: 2F 18	SRF.GCE.000	1611
Ped30: 2BF 18	SRH.GCE.000	1611

	Product No.	List \$
36 Deep Drawer Pedestals † 18w 36d 28.4h Unfinished Back		
Ped36: 2F 18	SRF.GCF.000	1995
Ped36: 2BF 18	SRH.GCF.000	1995

Locks are included.

+ Options (all items this section)

Pedestals are standard with veneer.

For a unit with finished back, change the 8th digit from 0 to 1; add \$118.

For a Wood1 Solid Color finish, change the last digit to 1.

For a veneer unit with solid color drawer faces, change the last digit to 4.

For a solid color unit with veneer drawer faces, change the last digit to 5.

Standard pull finish is Resin Aluminum. For Polished Aluminum on pulls, specify Option AP; add \$28.

Pedestals/Mobile

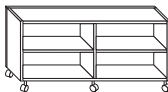

	Product No.	List \$
18 Deep † 18w 18d 27h		
• PedMobile18 (4s): Shelving 18	SRA.KCC.010	1357
• PedMobile18 (4s): Cabinet LH 18	SRB.KCC.010	1590
PedMobile18 (4s): Cabinet RH 18	SRC.KCC.010	1590

	Product No.	List \$
24 Deep † 18w 24d 27h		
PedMobile24 (4s): 2B-F 18	SRH.KCD.010	1901
PedMobile24 (4s): 4B 18	SRK.KCD.010	1975

Note: When docking mobile pedestals into credenzas, you must use the next larger depth credenza.

	Product No.	List \$
15 Deep † w 15d 27h		
PedMobile15 (4s): Shelving 60	SRA.KKB.010	3069
PedMobile15 (4s): Shelving 72	SRA.KMB.010	3275

Locks are included where applicable.

Caster covers are satin aluminum.

+ Options (all items this section)

Pedestals are standard with veneer,

For a Wood1 Solid Color finish, change the last digit to 1.

For a veneer unit with solid color drawer faces, change the last digit to 4.

For a solid color unit with veneer drawer faces, change the last digit to 5.

Standard pull finish is Resin Aluminum.

For Polished Aluminum on pulls, specify Option AP; add \$28.

Specify: Product Number  
 Quantity  
 Tagging  
 Wood Finish  
 Hardware Finish

• Denotes item illustrated  
 ‡ Requires field sub-assembly

Prices listed in Wood1 Finishes.

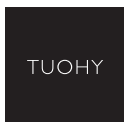

Hutch/Panel 42

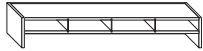

	Wood Cubby	w		Product No.	List \$	Product No.	List \$
• Hutch42:	WoodCubby	72		SKA.AMG.E00	1737		

Dimensions: 72w 15d 12.1h

Hutch/Panel 54

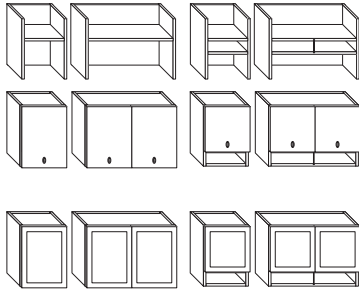

	Wood Shelving and Cabinets	w	Sg\Ndbl Shelf	Demi-Door		w. Cubby	
• Hutch54:	WoodShelving1 18	18	2\0	SKA.ACJ.A00	662	SKA.ACJ.E00	801
• Hutch54:	WoodShelving1 36	36	0\2	SKA.AFJ.A00	975	SKA.AFJ.E00	1284
• Hutch54:	Cabinet2 LH 18	18	2\0	SKB.ECJ.A00	949	SKB.ECJ.E00	1086
• Hutch54:	Cabinet2 RH 18	18	2\0	SKB.FCJ.A00	949	SKB.FCJ.E00	1086
• Hutch54:	Cabinet2 36	36	0\2	SKB.AFJ.A00	1181	SKB.AFJ.E00	1490

	Glass Doors	w	Sg\Ndbl Shelf				
• Hutch54:	GlassDrs&Shlvs2 LH 18	18	2\0	SKC.ECJ.A00	1084	SKC.ECJ.E00	1240
• Hutch54:	GlassDrs&Shlvs2 RH 18	18	2\0	SKC.FCJ.A00	1084	SKC.FCJ.E00	1240
• Hutch54:	GlassDrs&Shlvs 36	36	0\2	SKC.AFJ.A00	1454	SKC.AFJ.E00	1788

Dimensions: widths as listed 15d 24.2h

! Note: Units with Glass Doors are not available with Option LD Locks.  
For inner cabinet lights, specify Option IL; add \$132 per light (one per door recommended).

Hutch/Panel 72-Wood Group

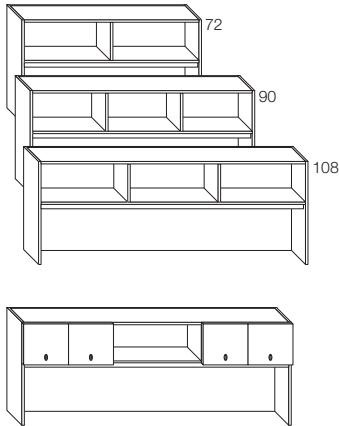

	Shelving1 w. Wood Back	w	Sg\Ndbl Shv	Shelving		w. Cubby	
Hutch72:	WoodShelving1 72	72	0\2	SKA.AMM.C00	2199	SKA.AMM.E00	2878
Hutch72:	WoodShelving1 90	90	0\3	SKA.AQM.C00	2464	SKA.AQM.E00	3220
Hutch72:	WoodShelving1 108	108	0\3	SKA.ASM.C00	2726	SKA.ASM.E00	3611

	Shelving1 w. Fabric Panel	w	Sg\Ndbl Shv	COM yd			
Hutch72:	WoodShelving1/Fab 72	72	0\2	2.3	SKA.BMM.B00	2680	SKA.BMM.D00 3360
Hutch72:	WoodShelving1/Fab 90	90	0\3	2.8	SKA.BQM.B00	3018	SKA.BQM.D00 3772
Hutch72:	WoodShelving1/Fab 108	108	0\3	3.2	SKA.BSM.B00	3311	SKA.BSM.D00 4197

	Cab1-WoodShelf1 w. Wood Back	w	Sg\Ndbl Shv	Cabinet-Shelf		w. Cubby	
Hutch72:	Cab1-Shv1-Cab1 72	72	0\2	SKE.NMM.C00	3060	SKE.NMM.E00	3740
Hutch72:	Cab1-Shv1-Cab1 108	108	0\3	SKE.NSM.C00	3456	SKE.NSM.E00	4341

	Cab1-WoodShelf1 w. Fabric Panel	w	Sg\Ndbl Shv	COM yd			
Hutch72:	Cab1-Shv1-Cab1/Fab 72	72	0\2	2.3	SKE.NMM.B00	3535	SKE.NMM.D00 4215
Hutch72:	Cab1-Shv1-Cab1/Fab 108	108	0\3	3.2	SKE.NSM.B00	4035	SKE.NSM.D00 4920

	Cabinet1 w. Wood Back	w	Sg\Ndbl Shv	Cabinet		w. Cubby	
Hutch72:	Cabinet1 36	36	0\1	SKB.AFM.C00	2066	SKB.AFM.E00	2375
Hutch72:	Cabinet1 54	54	1\1	SKB.AJM.C00	2329	SKB.AJM.E00	2761
Hutch72:	Cabinet1 72	72	0\2	SKB.AMM.C00	2726	SKB.AMM.E00	3407
Hutch72:	Cabinet1 90	90	1\2	SKB.AQM.C00	3122	SKB.AQM.E00	3878
Hutch72:	Cabinet1 108	108	0\3	SKB.ASM.C00	3517	SKB.ASM.E00	4401

	Cabinet1 w. Fabric Panel	w	Sg\Ndbl Shv	COM yd			
Hutch72:	Cabinet1/Fab 36	36	0\1	1.8	SKB.AFM.B00	2342	SKB.AFM.D00 2651
Hutch72:	Cabinet1/Fab 54	54	1\1	2	SKB.AJM.B00	2779	SKB.AJM.D00 3209
Hutch72:	Cabinet1/Fab 72	72	0\2	2.3	SKB.AMM.B00	3208	SKB.AMM.D00 3888
Hutch72:	Cabinet1/Fab 90	90	1\2	2.8	SKB.AQM.B00	3677	SKB.AQM.D00 4434
Hutch72:	Cabinet1/Fab 108	108	0\3	3.2	SKB.ASM.B00	4105	SKB.ASM.D00 4990

Dimensions: widths as listed 15d 41.3h

! Note: Fabric Panels on 108w units are produced in two sections.

+ Options (all items this page)

Standard cabinet pull finish is Resin Alum. For Polished Aluminum on pulls, specify Option AP; add \$35.

Specify: Product Number  
Quantity  
Tagging  
Wood Finish  
Hardware Finish

• Denotes item illustrated  
‡ Requires field sub-assembly

Prices listed in Wood1 Finishes.



Hutch/Panel 72-Wood Group (cont.)

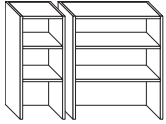

	Full Height Wood Shelving	w	Sg\Ndbl Shv	Product No.	List \$	Product No.	List \$
• Hutch72:	WoodShelving3 18	18	3\0	SKA.CCM.A00	1686		
• Hutch72:	WoodShelving3 36	36	0\3	SKA.CFM.A00	2212		

Includes one fixed shelf and one adjustable shelf.

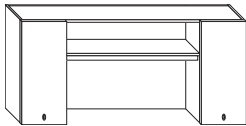

	Cab3-WoodShelf1 w. Wood Back	w	Sg\Ndbl Shv	Cabinet-Shelf	Cab/Cubby-Shelf
• Hutch72:	Cab3-WdShv1-Cab3	90	6\1	SKE.PQM.C00	3781 SKE.PQM.E00 4214

	Cab3-WoodShelf3 w. Fabric Panel		COM yd		
Hutch72:	Cab3-WdShv1/Fab-Cab3	90	6\1	2	SKE.PQM.B00 4229 SKE.PQM.D00 4663

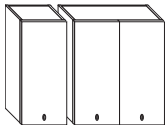

	Full Height Cabinet	w	Sg\Ndbl Shv	Cabinet	Cabinet w. Cubby
• Hutch72:	Cabinet3 LH 18	18	3\0	SKB.JCM.A00 1949	SKB.JCM.E00 2089
• Hutch72:	Cabinet3 RH 18	18	3\0	SKB.KCM.A00 1949	SKB.KCM.E00 2089
• Hutch72:	Cabinet3 36	36	0\3	SKB.CCM.A00 2706	SKB.CCM.E00 3014

Dimensions: widths as listed 15d 41.3h

+ Options (all items this page)

Standard pull finish is Resin Aluminum. For Polished Aluminum on pulls, specify Option AP; add \$32.

! Important—for all hutches:

Units are intended to be placed against a wall, hence have unfinished backs.



Specify: Product Number  
 Quantity  
 Tagging  
 Wood Finish  
 Hardware Finish

• Denotes item illustrated

Prices listed in Wood1 Finishes.

Hutch/Panel 72-Glass Group

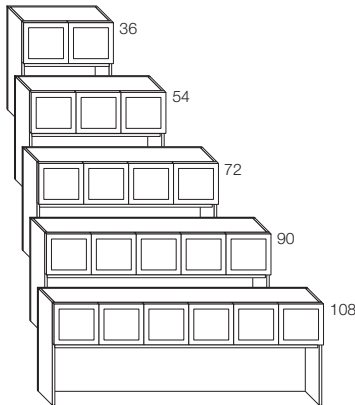
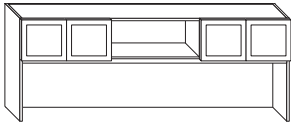

			Product No.	List \$	Product No.	List \$
Glass1-WoodShelf1 w. Wood Back	w	Sg\Ndbl Shv	Cabinet-Shelf		w. Cubby	
Hutch72: Gls1-WdShv1-Gls1 72	72	0\2	SKG.AMM.C00 3393		SKG.AMM.E00 4074	
• Hutch72: Gls1-WdShv1-Gls1 108	108	0\3	SKG.ASM.C00 3960		SKG.ASM.E00 4845	

Glass1-WoodShelf1 w. Fabric Panel	COM yd					
Hutch72: Gls1-WdShv1-Gls1/Fab 72	72	0\2	2.3	SKG.AMM.B00 3878	SKG.AMM.D00 4558	
Hutch72: Gls1-WdShv1-Gls1/Fab 108	108	0\3	3.2	SKG.ASM.B00 4546	SKG.ASM.D00 5430	

Glass1 w. Wood Back	w	Sg\Ndbl Shv	Cabinet	w. Cubby	
• Hutch72: Glass1 36	36	0\1	SKC.AFM.C00 2235	SKC.AFM.E00 2543	
• Hutch72: Glass1 54	54	1\1	SKC.AJM.C00 2582	SKC.AJM.E00 3013	
• Hutch72: Glass1 72	72	0\2	SKC.AMM.C00 3061	SKC.AMM.E00 3741	
• Hutch72: Glass1 90	90	1\2	SKC.AQM.C00 3539	SKC.AQM.E00 4295	
• Hutch72: Glass1 108	108	0\3	SKC.ASM.C00 4019	SKC.ASM.E00 4904	

Glass1 w. Fabric Panel	COM yd					
Hutch72: Glass1/Fab 36	36	0\1	1.8	SKC.AFM.B00 2508	SKC.AFM.D00 2820	
Hutch72: Glass1/Fab 54	54	1\1	2	SKC.AJM.B00 3029	SKC.AJM.D00 3461	
Hutch72: Glass1/Fab 72	72	0\2	2.3	SKC.AMM.B00 3541	SKC.AMM.D00 4222	
Hutch72: Glass1/Fab 90	90	1\2	2.8	SKC.AQM.B00 4095	SKC.AQM.D00 4850	
Hutch72: Glass1/Fab 108	108	0\3	3.2	SKC.ASM.B00 4605	SKC.ASM.D00 5491	

Dimensions: widths as listed 15d 41.3h  
 Doors have frosted glass in an a satin aluminum frame.  
 ! Note: Units with Glass Doors are not available with Option LD Locks.  
 ! Note: Fabric Panels on 108w units are produced in two sections.

+ Options (all items this page)

For inner cabinet lights, specify Option IL; add \$132 per light (one per door recommended).

PRIVATE OFFICE: **SALONE**

Specify: Product Number  
Quantity  
Tagging  
Wood Finish  
Hardware Finish

• Denotes item illustrated

Prices listed in Wood1 Finishes.

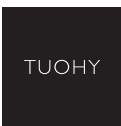

Hutch/Panel 72-Glass Group (cont.)

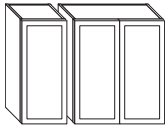

			Product No.	List \$	Product No.	List \$
	Full Height Glass Doors	w Sg\Ndbl Shv	Glass Doors		GIDrs w. Cubby	
•	Hutch72: GlsDrs&Shv3 LH 18	18 3\0	SKC.JCM.A00 2287		SKC.JCM.E00 2422	
	Hutch72: GlsDrs&Shv3 RH 18	18 3\0	SKC.KCM.A00 2287		SKC.KCM.E00 2422	
•	Hutch72: GlsDrs&Shv3 36	36 0\3	SKC.CFM.A00 3376		SKC.CFM.E00 3684	

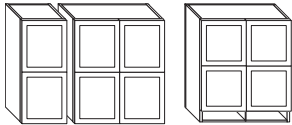

w. Cubby

			DemiGlass Doors		Demi w. Cubby	
•	Hutch72: DemiGls&Shv LH18	18 3\0	SKD.JCM.A00 2619		SKD.JCM.E00 2756	
	Hutch72: DemiGls&Shv RH18	18 3\0	SKD.KCM.A00 2619		SKD.KCM.E00 2756	
•	Hutch72: DemiGls&Shv 36	36 0\3	SKD.CFM.A00 4045		SKD.CFM.E00 4356	

Dimensions: widths as listed 15d 41.3h  
 Doors have frosted glass in an a satin aluminum frame.  
 ! Note: Units with Glass Doors are not available with Option LD Locks.

+ Options (all items this page)

For inner cabinet lights, specify Option IL; add \$132 per light (one per door recommended).

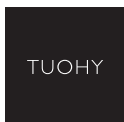

Specify: Product Number  
 Quantity  
 Tagging  
 Wood Finish  
 Hardware Finish

• Denotes item illustrated

Prices listed in Wood1 Finishes.

Hutch/Panel 85-Wood Group

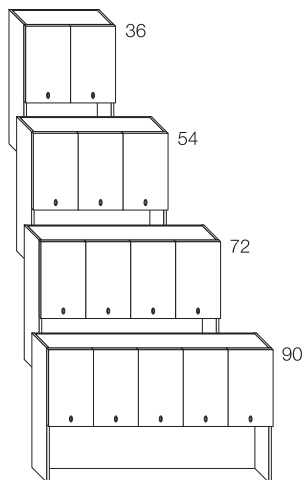

Cabinet2 w. Wood Back		w	Sg\Ndbl Shv	Cabinet	List \$	w. Cubby	Product No.	List \$
• Hutch85: Cabinet2	36	36	0\2	SKB.BFP.C00	2606	SKB.BFP.E00	2919	
• Hutch85: Cabinet2	54	54	2\2	SKB.BJP.C00	2805	SKB.BJP.E00	3237	
• Hutch85: Cabinet2	72	72	0\4	SKB.BMP.C00	3359	SKB.BMP.E00	4039	
• Hutch85: Cabinet2	90	90	2\4	SKB.BQP.C00	3913	SKB.BQP.E00	4668	

Cabinet2 w. Fabric Panel				COM yd					
Hutch85: Cabinet2/Fab	36	36	0\2	1.8	SKB.BFP.B00	3054	SKB.BFP.D00	3364	
Hutch85: Cabinet2/Fab	54	54	2\2	2	SKB.BJP.B00	3253	SKB.BJP.D00	3684	
Hutch85: Cabinet2/Fab	72	72	0\4	2.3	SKB.BMP.B00	3841	SKB.BMP.D00	4522	
Hutch85: Cabinet2/Fab	90	90	2\4	2.8	SKB.BQP.B00	4468	SKB.BQP.D00	5224	

Dimensions: widths as listed 15d 53.9h

+ Options (all items this page)

Standard cabinet pull finish is Resin Alum. For Polished Aluminum on pulls, specify Option AP; add \$35.

PRIVATE OFFICE: **SALONE**

Specify: Product Number  
Quantity  
Tagging  
Wood Finish  
Hardware Finish

• Denotes item illustrated

Prices listed in Wood1 Finishes.



Hutch/Panel 85-Wood Group (cont.)

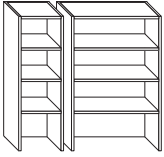

	Full Height Wood Shelving	w	Sg\Ndbl Shv	Product No.	List \$	Product No.	List \$
• Hutch85: WoodShelving4	18	4\0		SKA.DCP.A00	1997		
• Hutch85: WoodShelving4	36	0\4		SKA.DFP.A00	2619		

Dimensions: widths as listed 15d 53.9h  
 Includes one fixed shelf and two adjustable shelves.

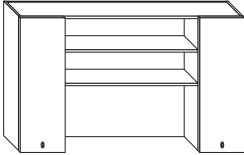

	Cabinet4-Shelves2 w. Wood Back	w	Sg\Ndbl Shv	Cabinet-Shelving	Cab/Cubby-Shv
• Hutch85: Cab4-Shv2-Cab4	90	8\2		SKE.QQP.C00	4727 SKE.QQP.E00 5158

	Cabinet4-Shelves2 w. Fabric Panel	w	Sg\Ndbl Shv	COM yd	Cabinet-Shelving	Cab/Cubby-Shv
Hutch85: Cab4-Shv2/Fab-Cab4	90	8\2	2	SKE.QQP.B00	5168	SKE.QQP.D00 5601

Dimensions: 90w 15d 53.9h

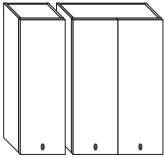

	Full Height Cabinets	w	Sg\Ndbl Shv	Cabinet	Cabinet w. Cubby
• Hutch85: Cabinet4 LH 18	18	4\0		SKB.LCP.A00	2526 SKB.LCP.E00 2665
Hutch85: Cabinet4 RH 18	18	4\0		SKB.MCP.A00	2526 SKB.MCP.E00 2665
• Hutch85: Cabinet4 36	36	0\4		SKB.DFP.A00	3675 SKB.DFP.E00 3984

Dimensions: widths as listed 15d 53.9h

+ Options (all items this page)

Standard pull finish is Resin Aluminum. For Polished Aluminum on pulls, specify Option AP; add \$33.

PRIVATE OFFICE: SALONE



Specify: Product Number  
 Quantity  
 Tagging  
 Wood Finish  
 Hardware Finish

• Denotes item illustrated

Prices listed in Wood1 Finishes.

Hutch/Panel 85-Glass Group

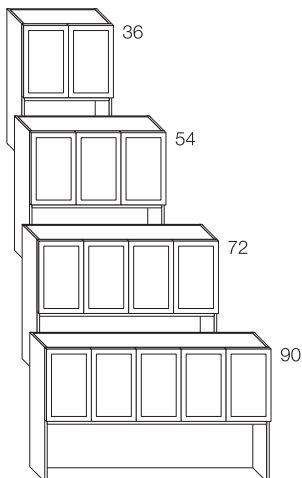

	Product No.	List \$	Product No.	List \$
Glass2 w. Wood Back				
• Hutch85: Glass2 36	SKB.BFP.G00	2649	SKB.BFP.J00	2958
• Hutch85: Glass2 54	SKB.BJP.G00	3152	SKB.BJP.J00	3583
• Hutch85: Glass2 72	SKB.BMP.G00	3819	SKB.BMP.J00	4500
• Hutch85: Glass2 90	SKB.BQP.G00	4492	SKB.BQP.J00	5246

Glass2 w. Fabric Panel	COM yd			
Hutch85: Glass2/Fab 36	SKB.BFP.F00	3097	SKB.BFP.H00	3407
Hutch85: Glass2/Fab 54	SKB.BJP.F00	3599	SKB.BJP.H00	4032
Hutch85: Glass2/Fab 72	SKB.BMP.F00	4302	SKB.BMP.H00	4983
Hutch85: Glass2/Fab 90	SKB.BQP.F00	5047	SKB.BQP.H00	5801

Dimensions: widths as listed 15d 53.9h  
Doors have frosted glass in an a satin aluminum frame.  
! Note: Units with Glass Doors are not available with Option LD Locks.

+ Options (all items this page)

For inner cabinet lights, specify Option IL; add \$132 per light (one per door recommended).

PRIVATE OFFICE: SALONE

Specify: Product Number  
Quantity  
Tagging  
Wood Finish  
Hardware Finish

• Denotes item illustrated

Prices listed in Wood1 Finishes.



Hutch/Panel 85-Glass Group (cont.)

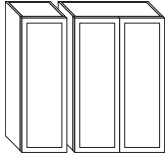

	w	Sgl\Ndbl Shv	Product No.	List \$	Product No.	List \$
Full Height Glass Doors			GlassDoors		w. Cubby	
Hutch85: GlsDrs&Shlvs4 LH 18	18	4\0	SKC.LCP.A00	2860	SKC.LCP.E00	2999
Hutch85: GlsDrs&Shlvs4 RH 18	18	4\0	SKC.MCP.A00	2860	SKC.MCP.E00	2999
Hutch85: GlsDrs&Shlvs4 36	36	0\4	SKC.DCP.A00	3815	SKC.DCP.E00	4126

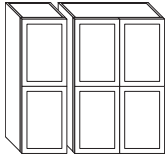

	w	Sgl\Ndbl Shv	Product No.	List \$	Product No.	List \$
Demi Glass Doors			Demi Glass		w. Cubby	
Hutch85: DemiGls&Shlvs LH18	18	4\0	SKD.LCP.A00	3195	SKD.LCP.E00	3333
Hutch85: DemiGls&Shlvs RH18	18	4\0	SKD.MCP.A00	3195	SKD.MCP.E00	3333
Hutch85: DemiGls&Shlvs 36	36	0\4	SKD.DCP.A00	4487	SKD.DCP.E00	4796

Dimensions: widths as listed 15d 53.9h  
 Doors have frosted glass in an a satin aluminum frame.  
 ! Note: Units with Glass Doors are not available with Option LD Locks.

+ Options (all items this page)

For inner cabinet lights, specify Option IL; add \$132 per light (one per door recommended).



Specify: Product Number  
 Quantity  
 Tagging  
 Wood Finish  
 Hardware Finish

• Denotes item illustrated

Prices listed in Wood1 Finishes.

Hutch/Column 42

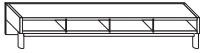

	Product No.	List \$	Product No.	List \$
Wood Cubby ‡				
• Hutch/Col42: WoodCubby	72		SKA.AMG.J00 1923	

Dimensions: 72w 15d 12.1h

Hutch/Column 72-Wood Group

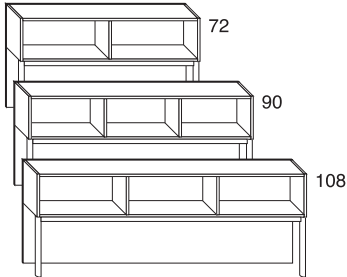

Shelving1 w. Wood Back ‡	w	Sgl\Tbl Shv	Shelving	w. Cubby
• Hutch/Col72: WoodShelving1 72	72	0\2	SKA.AMM.G00 2479	SKA.AMM.J00 3159
• Hutch/Col72: WoodShelving1 90	90	0\3	SKA.AQM.G00 2746	SKA.AQM.J00 3501
• Hutch/Col72: WoodShelving1 108	108	0\3	SKA.ASM.G00 3008	SKA.ASM.J00 3892

Shelving1 w. Fabric Panel ‡	w	Sgl\Tbl Shv	COM yd	
Hutch/Col72: WdShelving1/Fab 72	72	0\2	2.3	SKA.BMM.F00 2960 SKA.DMM.H00 3641
Hutch/Col72: WdShelving1/Fab 90	90	0\3	2.8	SKA.BQM.F00 3300 SKA.DQM.H00 4056
Hutch/Col72: WdShelving1/Fab 108	108	0\3	3.2	SKA.BSM.F00 3594 SKA.DSM.H00 4477

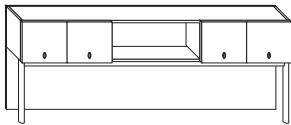

Cab1-WoodShelf1 w. Wood Back ‡	w	Sgl\Tbl Shv	Cab-Shv	w. Cubby
Hutch/Col72: Cab1-Shv1-Cab172	72	0\2	SKG.NMM.G00 3339	SKG.NMM.J00 4021
• Hutch/Col72: Cab1-Shv1-Cab1108	108	0\3	SKG.NSM.G00 3739	SKG.NSM.J00 4624

Cab1-WoodShelf1 w. Fabric Panel ‡	w	Sgl\Tbl Shv	COM yd	
Hutch/Col72: Cb1-Shv1-Cb1/Fab72	72	0\2	2.3	SKG.NMM.F00 3815 SKG.NMM.H00 4496
Hutch/Col72: Cb1-Shv1-Cb1/Fab108	108	0\3	3.2	SKG.NSM.F00 4316 SKG.NSM.H00 5200

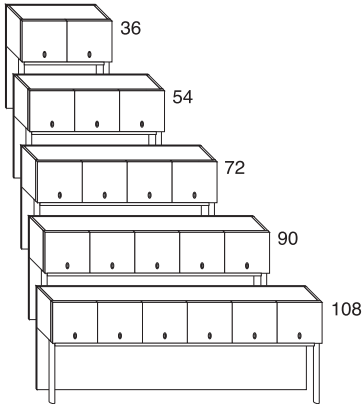

Cabinet1 w. Wood Back ‡	w	Sgl\Tbl Shv	Cabinet	w. Cubby
• Hutch/Col72: Cabinet1 36	36	0\1	SKB.AFM.G00 2348	SKB.AFM.J00 2656
• Hutch/Col72: Cabinet1 54	54	1\1	SKB.AJM.G00 2614	SKB.AJM.J00 3045
• Hutch/Col72: Cabinet1 72	72	0\2	SKB.AMM.G00 3008	SKB.AMM.J00 3687
• Hutch/Col72: Cabinet1 90	90	1\2	SKB.AQM.G00 3403	SKB.AQM.J00 4160
• Hutch/Col72: Cabinet1 108	108	0\3	SKB.ASM.G00 3800	SKB.ASM.J00 4684

Cabinet1 w. Fabric Panel ‡	w	Sgl\Tbl Shv	COM yd	
Hutch/Col72: Cabinet1/Fab 36	36	0\1	1.8	SKB.AFM.F00 2623 SKB.AFM.H00 2931
Hutch/Col72: Cabinet1/Fab 54	54	1\1	2	SKB.AJM.F00 3058 SKB.AJM.H00 3492
Hutch/Col72: Cabinet1/Fab 72	72	0\2	2.3	SKB.AMM.F00 3489 SKB.AMM.H00 4168
Hutch/Col72: Cabinet1/Fab 90	90	1\2	2.8	SKB.AQM.F00 3960 SKB.AQM.H00 4714
Hutch/Col72: Cabinet1/Fab 108	108	0\3	3.2	SKB.ASM.F00 4386 SKB.ASM.H00 5272

Dimensions: widths as listed 15d 41.3h  
All units include two Resin Aluminum columns; see options below.  
! Note: Fabric Panels on 108w units are produced in two sections.

+ Options (all items this page except Hutch/Column 42)

- Standard configuration is Column / Column (in LH / RH order).
- For Column / Light: Specify Option CL; add \$183.
- For Column / Power-Data: Specify Option CP; add \$183.
- For Light / Column: Specify Option LC; add \$183.
- For Light / Light: Specify Option LL; add \$368.
- For Light / Power-Data: Specify Option LP; add \$368.
- For Power-Data / Column: Specify Option PC; add \$183.
- For Power-Data / Light: Specify Option PL; add \$368.
- For Power-Data / Power-Data: Specify Option PP; add \$368.

Standard pull finish is Resin Aluminum. For Polished Aluminum on pulls, specify Option AP; add \$35.

Specify: Product Number  
Quantity  
Tagging  
Wood Finish  
Hardware Finish

• Denotes item illustrated  
‡ Requires field sub-assembly

Prices listed in Wood1 Finishes.

Hutch/Column 72-Glass Group

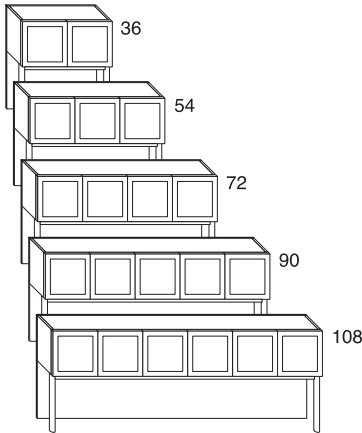
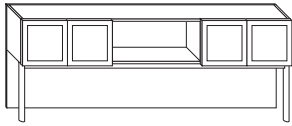

	Product No.	List \$	Product No.	List \$
Glass1 WoodShelf1 w. Wood Back ‡ w Sg\Ndbl Shv	Cab-Shv		w. Cubby	
Hutch/Col72: Gls1-Shv1-Gls1 72	72 0\2	SKG.AMM.G00 3676	SKG.AMM.J00 4357	
• Hutch/Col72: Gls1-Shv1-Gls1 108	108 0\3	SKG.ASM.G00 4241	SKG.ASM.J00 5125	

	COM yd			
Glass1 WoodShelf1 w. Fabric Panel ‡				
Hutch/Col72: Gls1-Shv1-Gls1/Fab 72	72 0\2	2.3	SKG.AMM.F00 4159	SKG.AMM.H00 4838
Hutch/Col72: Gls1-Shv1-Gls1/Fab108	108 0\3	3.2	SKG.ASM.F00 4826	SKG.ASM.H00 5710

Glass1 w. Wood Back ‡	w Sg\Ndbl Shv	Cabinet		w. Cubby
• Hutch/Col72: Glass1 36	36 0\1	SKC.AFM.G00 2516	SKC.AFM.J00 2824	
• Hutch/Col72: Glass1 54	54 1\1	SKC.AJM.G00 2862	SKC.AJM.J00 3295	
• Hutch/Col72: Glass1 72	72 0\2	SKC.AMM.G00 3340	SKC.AMM.J00 4022	
• Hutch/Col72: Glass1 90	90 1\2	SKC.AQM.G00 3819	SKC.AQM.J00 4574	
• Hutch/Col72: Glass1 108	108 0\3	SKC.ASM.G00 4300	SKC.ASM.J00 5185	

Glass1 w. Fabric Panel ‡				
Hutch/Col72: Glass1/Fab 36	36 0\1	1.8	SKC.AFM.F00 2791	SKC.AFM.H00 3100
Hutch/Col72: Glass1/Fab 54	54 1\1	2	SKC.AJM.F00 3309	SKC.AJM.H00 3742
Hutch/Col72: Glass1/Fab 72	72 0\2	2.3	SKC.AMM.F00 3825	SKC.AMM.H00 4502
Hutch/Col72: Glass1/Fab 90	90 1\2	2.8	SKC.AQM.F00 4376	SKC.AQM.H00 5131
Hutch/Col72: Glass1/Fab 108	108 0\3	3.2	SKC.ASM.F00 4887	SKC.ASM.H00 5772

Dimensions: widths as listed 15d 41.3h  
 Doors have frosted glass in an a satin aluminum frame.  
 ! Note: Units with Glass Doors are not available with Option LD Locks.  
 ! Note: Fabric Panels on 108w units are produced in two sections.

+ Options (all items this page)

Standard configuration is Column / Column (in LH / RH order).

Column / Light	Specify Option CL	Add \$176.
Column / Power-Data	Specify Option CP	Add \$176.
Light / Column	Specify Option LC	Add \$176.
Light / Light	Specify Option LL	Add \$354.
Light / Power-Data	Specify Option LP	Add \$354.
Power-Data / Column	Specify Option PC	Add \$176.
Power-Data / Light	Specify Option PL	Add \$354.
Power-Data / Power-Data	Specify Option PP	Add \$354.

For inner cabinet lights, specify Option IL; add \$132 per light (one per door recommended).

! Important—for all hutches:  
 Units are intended to be placed against a wall, hence have unfinished backs.



Specify: Product Number  
 Quantity  
 Tagging  
 Wood Finish  
 Hardware Finish

• Denotes item illustrated  
 ‡ Requires field sub-assembly

Prices listed in Wood1 Finishes.

Hutch/Column 85-Wood Group

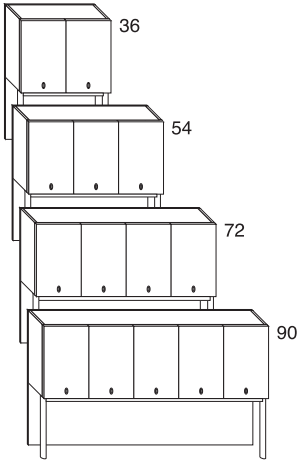

Cabinet2 w. Wood Back ‡		w	Sg\Ndbl Shv	Cabinet	List \$	w. Cubby	List \$
• Hutch/Col85: Cabinet2 36	36	0\2		SKC.BJP.C00	3009	SKC.BJP.E00	3318
• Hutch/Col85: Cabinet2 54	54	2\2		SKC.BMP.C00	3207	SKC.BMP.E00	3639
• Hutch/Col85: Cabinet2 72	72	0\4		SKC.BQP.C00	3761	SKC.BQP.E00	4441
• Hutch/Col85: Cabinet2 90	90	2\4		SKC.BSP.C00	4314	SKC.BSP.E00	5070

Cabinet2 w. Fabric Panel ‡		COM yd			List \$		List \$
Hutch/Col85: Cabinet2/Fab 36	36	0\2	1.8	SKC.BJP.B00	3456	SKC.BJP.D00	3767
Hutch/Col85: Cabinet2/Fab 54	54	2\2	2	SKC.BMP.B00	3653	SKC.BMP.D00	4087
Hutch/Col85: Cabinet2/Fab 72	72	0\4	2.3	SKC.BQP.B00	4243	SKC.BQP.D00	4922
Hutch/Col85: Cabinet2/Fab 90	90	2\4	2.8	SKC.BSP.B00	4871	SKC.BSP.D00	5626

Dimensions: widths as listed 15d 53.9h

+ Options (all hutches this and opposite page)

Standard configuration is Column / Column (in LH / RH order).

Column / Light	Specify Option CL	Add \$176.
Column / Power-Data	Specify Option CP	Add \$176.
Light / Column	Specify Option LC	Add \$176.
Light / Light	Specify Option LL	Add \$354.
Light / Power-Data	Specify Option LP	Add \$354.
Power-Data / Column	Specify Option PC	Add \$176.
Power-Data / Light	Specify Option PL	Add \$354.
Power-Data / Power-Data	Specify Option PP	Add \$354.

Specify: Product Number  
Quantity  
Tagging  
Wood Finish  
Hardware Finish

• Denotes item illustrated  
‡ Requires field sub-assembly

Prices listed in Wood1 Finishes.

Hutch/Column 85-Glass Group

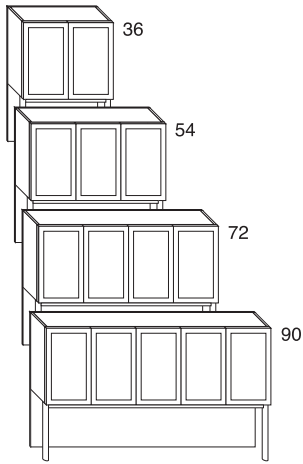

Glass2 w. Wood Back ‡	w	Sg\Ndbl Shv	Cabinet	Product No.	List \$	w. Cubby	Product No.	List \$
• Hutch/Col85: Glass2 36	36	0\2	SKC.BFP.G00	3051		SKC.BFP.J00	3360	
• Hutch/Col85: Glass2 54	54	2\2	SKC.BJP.G00	3555		SKC.BJP.J00	3985	
• Hutch/Col85: Glass2 72	72	0\4	SKC.BMP.G00	4222		SKC.BMP.J00	4903	
• Hutch/Col85: Glass2 90	90	2\4	SKC.BQP.G00	4893		SKC.BQP.J00	5649	

Glass2 w. Fabric Panel ‡	w	d	1.5th	COM yd	Product No.	List \$	Product No.	List \$
Hutch/Col85: Glass2/Fab 36	36	0\2	1.8	SKC.BFP.F00	3500		SKC.BFP.H00	3809
Hutch/Col85: Glass2/Fab 54	54	2\2	2	SKC.BJP.F00	3998		SKC.BJP.H00	4434
Hutch/Col85: Glass2/Fab 72	72	0\4	2.3	SKC.BMP.F00	4704		SKC.BMP.H00	5384
Hutch/Col85: Glass2/Fab 90	90	2\4	2.8	SKC.BQP.F00	5449		SKC.BQP.H00	6203

Dimensions: widths as listed 15d 53.9h  
Doors have frosted glass in an a satin aluminum frame.  
! Note: Units with Glass Doors are not available with Option LD Locks.

+ Options- (see listing on opposite page)

For inner cabinet lights, specify Option IL; add \$132 per light (one per door recommended).

Hutch Tops

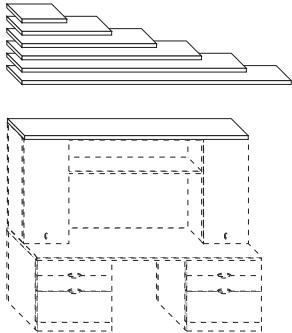

For Hutches and Wall Hutches ‡	w	d	1.5th	Units <= 54	Units > 54
• HutchTop 54/15: 18	18	15.1		STB.ACB.000 828	STA.ACB.000 296
• HutchTop 54/15: 36	36	15.1		STB.AFB.000 907	STA.AFB.000 402
• HutchTop 54/15: 54	54	15.1		STB.AJB.000 984	STA.AJB.000 576
• HutchTop 54/15: 72	72	15.1		STB.AMB.000 1060	STA.AMB.000 713
• HutchTop 54/15: 90	90	15.1		STB.AQB.000 1138	STA.AQB.000 852
• HutchTop 54/15: 108	108	15.1		STB.ASB.000 1229	STA.ASB.000 918

Hutch Tops for units <= 54 high have hardwood rails and grade 1 veneers  
Hutch Tops for units > 54 high have hardwood rails and secondary veneers

+ Options

For a Wood1 Solid Color finish, change the last digit to 1.



Specify: Product Number  
Quantity  
Tagging  
Wood Finish  
Hardware Finish

• Denotes item illustrated  
‡ Requires field sub-assembly

Prices listed in Wood1 Finishes.

Wall Hutch -Wood Group

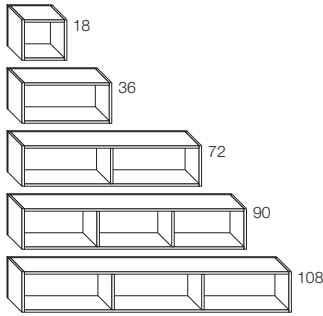

Shelving1 Wall Hutch	w	Sg\Ndbl Shelf	Shelving	List \$	Product No.	w. Cubby	List \$	Product No.
Hutch: WoodShelving1 18	18	1\0	SKA.ACC.K00	1246	SKA.ACC.L00	1386		
Hutch: WoodShelving1 36	36	0\1	SKA.AFC.K00	1491	SKA.AFC.L00	1801		
Hutch: WoodShelving1 72	72	0\2	SKA.AMC.K00	1890	SKA.AMC.L00	2570		
Hutch: WoodShelving1 90	90	0\3	SKA.AQC.K00	2201	SKA.AQC.L00	2956		
Hutch: WoodShelving1 108	108	0\3	SKA.ASC.K00	2553	SKA.ASC.L00	3438		

Dimensions: widths as listed 15d 18h (24h for units with cubby).  
Mounting hardware included.

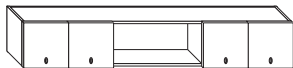

Cabinet1-Shelf1 Wall Hutch	w	Sg\Ndbl Shelf	Cab-Shelf-Cab	List \$	Product No.	w. Cubby	List \$	Product No.
Hutch: Cab1-WoodShelf1-Cab1 108	108	0\3	SKE.ASC.K00	3088	SKE.ASC.L00	3972		

Dimensions: width as listed 15d 18h (24h for units with cubby).  
Mounting hardware included.

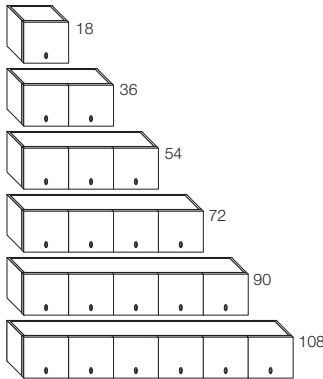

Cabinet1 Wall Hutch	w	Sg\Ndbl Shelf	Cabinet	List \$	Product No.	w. Cubby	List \$	Product No.
Hutch: Cabinet1 LH 18	18	1\0	SKB.JCC.K00	1382	SKB.JCC.L00	1520		
Hutch: Cabinet1 RH 18	18	1\0	SKB.FCC.K00	1382	SKB.FCC.L00	1520		
Hutch: Cabinet1 36	36	0\1	SKB.AFC.K00	1761	SKB.AFC.L00	2070		
Hutch: Cabinet1 54	54	1\1	SKB.AJC.K00	2093	SKB.AJC.L00	2525		
Hutch: Cabinet1 72	72	0\2	SKB.AMC.K00	2426	SKB.AMC.L00	3105		
Hutch: Cabinet1 90	90	1\2	SKB.AQC.K00	2871	SKB.AQC.L00	3626		
Hutch: Cabinet1 108	108	0\3	SKB.ASC.K00	3357	SKB.ASC.L00	4242		

Dimensions: widths as listed 15d 18h (24h for units with cubby).  
Mounting hardware included.

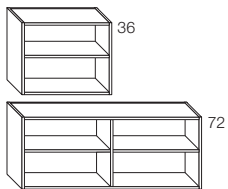

Shelving2 Wall Hutch	w	Sg\Ndbl Shelf	Shelving	List \$	Product No.	w. Cubby	List \$	Product No.
Hutch: WoodShelving2 18	18	2\0	SKA.BCC.K00	1497	SKA.BCC.L00	1636		
Hutch: WoodShelving2 36	36	0\2	SKA.BFC.K00	1727	SKA.BFC.L00	2038		
Hutch: WoodShelving2 72	72	0\4	SKA.BMC.K00	3086	SKA.BMC.L00	3767		
Hutch: WoodShelving2 90	90	0\6	SKA.BQC.K00	3504	SKA.BQC.L00	4260		

Dimensions: widths as listed 15d 30.6h (36.6h for units with cubby).  
Mounting hardware included.

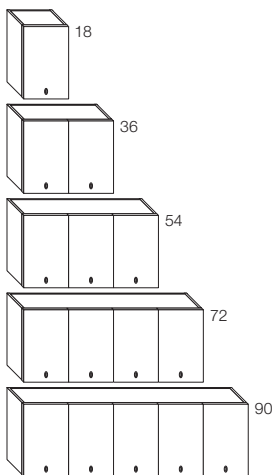

Cabinet2 Wall Hutch	w	Sg\Ndbl Shelf	Cabinet	List \$	Product No.	w. Cubby	List \$	Product No.
Hutch: Cabinet2 LH 18	18	2\0	SKB.GCC.K00	1689	SKB.GCC.L00	1827		
Hutch: Cabinet2 RH 18	18	2\0	SKB.HCC.K00	1689	SKB.HCC.L00	1827		
Hutch: Cabinet2 36	36	0\2	SKB.BFC.K00	2113	SKB.BFC.L00	2419		
Hutch: Cabinet2 54	54	2\2	SKB.BJC.K00	2981	SKB.BJC.L00	3290		
Hutch: Cabinet2 72	72	0\4	SKB.BMC.K00	3852	SKB.BMC.L00	4533		
Hutch: Cabinet2 90	90	2\4	SKB.BQC.K00	4463	SKB.BQC.L00	5218		

Dimensions: widths as listed 15d 30.6h (36.6h for units with cubby).  
Mounting hardware included.

+ Options (all items this page)

Refer to the Hutch Tops listing on a previous page for tops that can be used with Wall Hutches.  
Standard pull finish is Resin Aluminum. For Polished Aluminum on pulls, specify Option AP; add \$31.

Specify: Product Number  
Quantity  
Tagging  
Wood Finish  
Hardware Finish

• Denotes item illustrated

Prices listed in Wood1 Finishes.

Wall Hutch -Glass Group

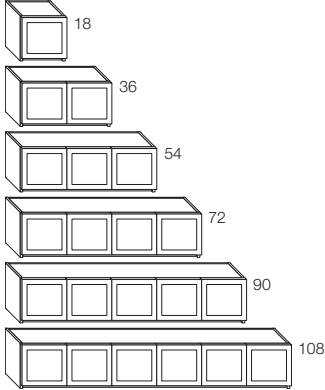
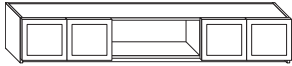

Fabric Panels, Wall Hung

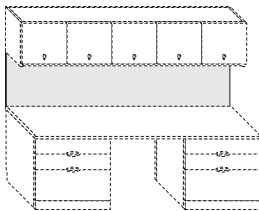

Product No. List \$ Product No. List \$

Glass1-Shelf1 Wall Hutch	w	Sg\Ndbl Shelf	Cab-Shelf-Cab	w. Cubby
Hutch: Gls1-WoodShelf1-Gls1 108	108	0\3	SKG.ASC.K00 3424	SKG.ASC.L00 4308

Dimensions: width as listed 15d 18h (24h for units with cubby).  
Doors have frosted glass in an a satin aluminum frame.  
Mounting hardware included.

Glass1 Wall Hutch	w	Sg\Ndbl Shelf	Cabinet	w. Cubby
Hutch: Glass1 LH 18	18	1\0	SKC.JCC.K00 1466	SKC.JCC.L00 1605
Hutch: Glass1 RH 18	18	1\0	SKC.FCC.K00 1466	SKC.FCC.L00 1605
Hutch: Glass1 36	36	0\1	SKC.AFC.K00 1928	SKC.AFC.L00 2237
Hutch: Glass1 54	54	1\1	SKC.AJC.K00 2343	SKC.AJC.L00 2778
Hutch: Glass1 72	72	0\2	SKC.AMC.K00 2758	SKC.AMC.L00 3439
Hutch: Glass1 90	90	1\2	SKC.AQC.K00 3289	SKC.AQC.L00 4044
Hutch: Glass1 108	108	0\3	SKC.ASC.K00 3860	SKC.ASC.L00 4744

Dimensions: widths as listed 15d 18h (24h for units with cubby).  
Doors have frosted glass in an a satin aluminum frame.  
Mounting hardware included.

Glass2 Wall Hutch	w	Sg\Ndbl Shelf	Cabinet	w. Cubby
Hutch: Glass2 LH 18	18	2\0	SKC.GCC.K00 1808	SKC.GCC.L00 1946
Hutch: Glass2 RH 18	18	2\0	SKC.HCC.K00 1808	SKC.HCC.L00 1946
Hutch: Glass2 36	36	0\2	SKC.BFC.K00 2344	SKC.BFC.L00 2654
Hutch: Glass2 54	54	2\2	SKC.BJC.K00 3333	SKC.BJC.L00 3642
Hutch: Glass2 72	72	0\4	SKC.BMC.K00 4321	SKC.BMC.L00 5000
Hutch: Glass2 90	90	2\4	SKC.BQC.K00 5048	SKC.BQC.L00 5802

Dimensions: widths as listed 15d 30.6h (36.6h for units with cubby).  
Doors have frosted glass in an a satin aluminum frame.  
Mounting hardware included.

! Note: Units with Glass Doors are not available with Option LD Locks.

+ Options (all items above)

Wall Hutches are standard with veneer.  
For a Wood1 Solid Color finish, change the last digit to 1.  
For inner cabinet lights, specify Option IL; add \$132 per light (one per door recommended).

23.4 Height* ±	w	23.4h* COM yd	Cabinet	w. Cubby
Fabric Wall Panel: 36	36	1.8	SHW.FD0.000 276	SHW.FC0.000 276
Fabric Wall Panel: 54	54	2	SHW.JD0.000 450	SHW.JC0.000 450
Fabric Wall Panel: 72	72	2.3	SHW.MD0.000 482	SHW.MC0.000 482
Fabric Wall Panel: 90	90	2.8	SHW.QD0.000 552	SHW.QC0.000 552
Fabric Wall Panel: 108	108	3.2	SHW.SD0.000 586	SHW.SC0.000 586

36 Height* ±	w	36h* COM yd	Cabinet	w. Cubby
Fabric Wall Panel: 36X	36	1.8	SHW.FF0.000 276	SHW.FE0.000 276
Fabric Wall Panel: 54X	54	2	SHW.JF0.000 450	SHW.JE0.000 450
Fabric Wall Panel: 72X	72	2.3	SHW.MF0.000 482	SHW.ME0.000 482
Fabric Wall Panel: 90X	90	2.8	SHW.QF0.000 552	SHW.QE0.000 552
Fabric Wall Panel: 108X	108	3.2	SHW.SF0.000 586	SHW.SE0.000 586

Allow 1.5 inches depth for panels, including mounting brackets.  
Mounting hardware included.  
Panels allow for cord passage behind.

\* Height on units with Cubby is 6 inches less.

Specify: Product Number  
Quantity  
Tagging  
Wood Finish  
Hardware Finish

• Denotes item illustrated

Prices listed in Wood1 Finishes.

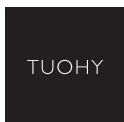

Towers54

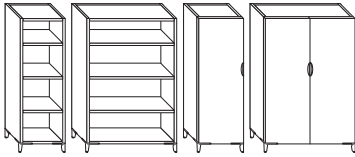

	15 Depth	w	15d	54h	Wood Base	Foot	Product No.	List \$	Product No.	List \$
•	Tower 54/15: Shelving 18	18					SGA.GCB.000	1202	SGA.HCB.000	1472
•	Tower 54/15: DblShelving 36	36					SGA.GFB.000	2565	SGA.HFB.000	2836
•	Tower 54/15: Cabinet LH 18	18					SGB.GCB.000	1435	SGB.HCB.000	1708
•	Tower 54/15: Cabinet RH 18	18					SGC.GCB.000	1435	SGC.HCB.000	1708
•	Tower 54/15: DblCabinet 36	36					SGD.GFB.000	3160	SGD.HFB.000	3435

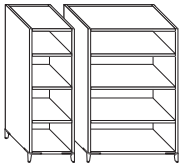

	24 Depth Shelving	w	24d	54h	Wood Base	Foot	Product No.	List \$	Product No.	List \$
	Tower 54/24: Shelving 18	18					SGA.GCD.000	1539	SGA.HCD.000	1811
	Tower 54/24: DblShelving 36	36					SGA.GFD.000	3083	SGA.HFD.000	3356

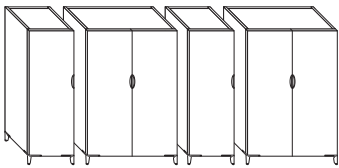

	24 Depth Cabinets	w	24d	54h	Wood Base	Foot	Product No.	List \$	Product No.	List \$
•	Tower 54/24: Cabinet LH 18	18					SGB.GCD.000	1760	SGB.HCD.000	2030
	Tower 54/24: Cabinet RH 18	18					SGC.GCD.000	1760	SGC.HCD.000	2030
	Tower 54/24: Cabinet LH 24	24					SGB.GDD.000	2173	SGB.HDD.000	2447
	Tower 54/24: Cabinet RH 24	24					SGC.GDD.000	2173	SGC.HDD.000	2447
•	Tower 54/24: DblCabinet 36	36					SGD.GFD.000	3578	SGD.HFD.000	3847
•	Tower 54/24: Garment LH 18	18					SGE.GCD.000	1733	SGE.HCD.000	2004
	Tower 54/24: Garment RH 18	18					SGF.GCD.000	1733	SGF.HCD.000	2004
•	Tower 54/24: Garment: Cab 36	36					SGG.GFD.000	3537	SGG.HFD.000	3811
	Tower 54/24: Cab: Garment 36	36					SGH.GFD.000	3537	SGH.HFD.000	3811



	24 Depth Cabinet/Drawers	36w	24d	54h	Wood Base	Foot	Product No.	List \$	Product No.	List \$
	Tower 54/24: Cab/LatF						SGJ.GFD.000	4162	SGJ.HFD.000	4435
	Tower 54/24: Cab/LatB/LatF						SGK.GFD.000	4319	SGK.HFD.000	4590

Wood Base

+ Options (all items this page)



Foot

Towers54 are standard with veneer, finished top surface, unfinished back.  
 For a unit with finished back, change the 8th digit from 0 to 1; add \$236.  
 For a Wood1 Solid Color finish, change the last digit to 1.  
 For a veneer unit with solid color drawer faces, change the last digit to 4.  
 For a solid color unit with veneer drawer faces, change the last digit to 5.

Standard foot and pull finish is Resin Aluminum. For Polished Aluminum, specify Option AP:  
 All Shelving types w. Foot: specify Option AP; add \$202.  
 All Cabinet types w. Foot: specify Option AP; add \$225.  
 All Cabinet types w. Wood Base: specify Option AP; add \$22.

Specify: Product Number  
 Quantity  
 Tagging  
 Wood Finish  
 Hardware Finish

• Denotes item illustrated

Prices listed in Wood1 Finishes.

Towers72

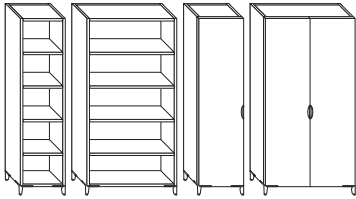

	15 Depth	w	15d	71.2h	Wood Base	Foot	Product No.	List \$	Product No.	List \$
•	Tower 72/15: Shelving 18	18			SGA.JCB.000	2017	SGA.KCB.000	2292		
•	Tower 72/15: Shelving 36	36			SGA.JFB.000	3099	SGA.KFB.000	3373		
•	Tower 72/15: Cabinet LH 18	18			SGB.JCB.000	2128	SGB.KCB.000	2402		
•	Tower 72/15: Cabinet RH 18	18			SGC.JCB.000	2128	SGC.KCB.000	2402		
•	Tower 72/15: DblCabinet 36	36			SGD.JFB.000	3704	SGD.KFB.000	3977		

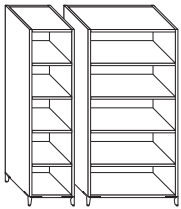

	24 Depth Shelving	w	24d	71.2h	Wood Base	Foot	Product No.	List \$	Product No.	List \$
	Tower 72/24: Shelving 18	18			SGA.JCD.000	2508	SGA.KCD.000	2783		
	Tower 72/24: Shelving 36	36			SGA.JFD.000	3688	SGA.KFD.000	3962		

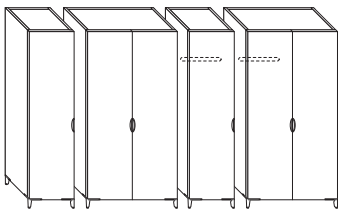

	24 Depth Cabinets	w	24d	71.2h	Wood Base	Foot	Product No.	List \$	Product No.	List \$
•	Tower 72/24: Cabinet LH 18	18			SGB.JCD.000	2665	SGB.KCD.000	2933		
	Tower 72/24: Cabinet RH 18	18			SGC.JCD.000	2665	SGC.KCD.000	2933		
	Tower 72/24: Cabinet LH 24	24			SGB.JDD.000	3290	SGB.KDD.000	3536		
	Tower 72/24: Cabinet RH 24	24			SGC.JDD.000	3290	SGC.KDD.000	3536		
•	Tower 72/24: DblCabinet 36	36			SGD.JFD.000	4520	SGD.KFD.000	4791		
•	Tower 72/24: Garment LH 18	18			SGE.JCD.000	2439	SGE.KCD.000	2710		
	Tower 72/24: Garment RH 18	18			SGF.JCD.000	2439	SGF.KCD.000	2710		
•	Tower 72/24: Garment: Cab 36	36			SGG.JFD.000	4294	SGG.KFD.000	4566		
	Tower 72/24: Cab: Garment 36	36			SGH.JFD.000	4294	SGH.KFD.000	4566		

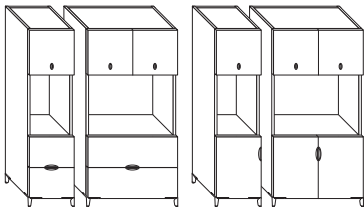

	24 Depth Cabinet/Shelving	w	24d	71.2h	Wood Base	Foot	Product No.	List \$	Product No.	List \$
•	Tower 72/24: Cab/Shlv/2F 18LH	18			SGU.JCD.000	2792	SGU.KCD.000	3063		
	Tower 72/24: Cab/Shlv/2F 18RH	18			SGV.JCD.000	2792	SGV.KCD.000	3063		
•	Tower 72/24: Cab/Shlv/LatF 36	36			SGL.JFD.000	4771	SGL.KFD.000	5045		
•	Tower 72/24: Cab/Shlv/Cab 18LH	18			SGW.JCD.000	2715	SGW.KCD.000	2985		
	Tower 72/24: Cab/Shlv/Cab 18RH	18			SGX.JCD.000	2715	SGX.KCD.000	2985		
•	Tower 72/24: Cab/Shlv/Cab 36	36			SGM.JFD.000	4617	SGM.KFD.000	4888		



	24 Depth Cabinet/Drawers	36w	24d	71.2h	Wood Base	Foot	Product No.	List \$	Product No.	List \$
	Tower 72/24: Cab/LatF 36				SGJ.JFD.000	5013	SGJ.KFD.000	5281		
	Tower 72/24: Cab/LatB/LatF 36				SGK.JFD.000	5179	SGK.KFD.000	5452		
	Tower 72/24: Cab/3LatF 36				SGN.JFD.000	5257	SGN.KFD.000	5528		

Wood Base    Foot

+ Options (all items this page)

Towers72 are standard with veneer, secondary veneers on top surface, unfinished back.  
 For a unit with finished back, change the 8th digit from 0 to 1; add \$261.  
 For a Wood1 Solid Color finish, change the last digit to 1.  
 For a veneer unit with solid color drawer faces, change the last digit to 4.  
 For a solid color unit with veneer drawer faces, change the last digit to 5.

Standard foot and pull finish is Resin Aluminum. For Polished Aluminum, specify Option AP:  
 All Shelving types w. Foot: specify Option AP; add \$202.  
 All Cabinet types w. Foot: specify Option AP; add \$231.  
 All Cabinet types w. Wood Base: specify Option AP; add \$27.



Specify: Product Number  
 Quantity  
 Tagging  
 Wood Finish  
 Hardware Finish

• Denotes item illustrated

Prices listed in Wood1 Finishes.

Towers85

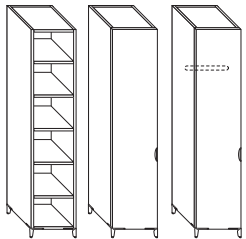
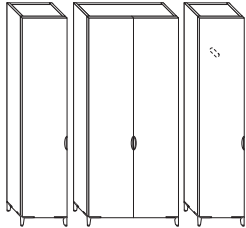
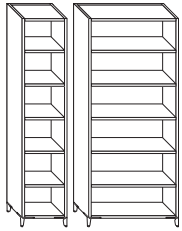

			Product No.	List \$	Product No.	List \$
15 Depth Shelving	w	15d	83.8h	Wood Base	Foot	
Tower 85/15: Shelving 18	18			SGA.LCB.000	2298	SGA.MCB.000 2571
Tower 85/15: DblShelving 36	36			SGA.LFB.000	3239	SGA.MFB.000 3511

				Product No.	List \$	Product No.	List \$
15 Depth Cabinets	w	15d	83.8h	Wood Base	Foot		
• Tower 85/15: Cabinet LH 18	18			SGB.LCB.000	2522	SGB.MCB.000 2795	
Tower 85/15: Cabinet RH 18	18			SGC.LCB.000	2522	SGC.MCB.000 2795	
• Tower 85/15: DblCabinet 36	36			SGD.LFB.000	3843	SGD.MFB.000 4115	
• Tower 85/15: Garment LH 18	18			SGE.LCB.000	2411	SGE.MCB.000 2683	
Tower 85/15: Garment RH 18	18			SGF.LCB.000	2411	SGF.MCB.000 2683	

				Product No.	List \$	Product No.	List \$
24 Depth	w	24d	83.8h	Wood Base	Foot		
• Tower 85/24: Shelving 18	18			SGA.LCD.000	2820	SGA.MCD.000 3090	
• Tower 85/24: Cabinet LH 18	18			SGB.LCD.000	3112	SGB.MCD.000 3386	
Tower 85/24: Cabinet RH 18	18			SGC.LCD.000	3112	SGC.MCD.000 3386	
Tower 85/24: Cabinet LH 24	24			SGB.LDD.000	3845	SGB.MDD.000 4079	
Tower 85/24: Cabinet RH 24	24			SGC.LDD.000	3845	SGC.MDD.000 4079	
• Tower 85/24: Garment LH 18	18			SGE.LCD.000	2958	SGE.MCD.000 3231	
Tower 85/24: Garment RH 18	18			SGF.LCD.000	2958	SGF.MCD.000 3231	

+ Options (all items above)

- Towers85 are standard with veneer, secondary veneers on top surface, unfinished back.
- For a unit with finished back, change the 8th digit from 0 to 1; add \$287.
- For a Wood1 Solid Color finish, change the last digit to 1.
- For a veneer unit with solid color drawer faces, change the last digit to 4.
- For a solid color unit with veneer drawer faces, change the last digit to 5.

Standard foot and pull finish is Resin Aluminum. For Polished Aluminum, specify Option AP:  
 All Shelving types w. Foot: specify Option AP; add \$202.  
 Cabinet types w. Foot: specify Option AP; add \$212.  
 Cabinet types w. Wood Base: specify Option AP; add \$10.

Specify: Product Number  
Quantity  
Tagging  
Wood Finish  
Hardware Finish

• Denotes item illustrated

Prices listed in Wood1 Finishes.

Tower Tops

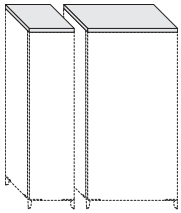
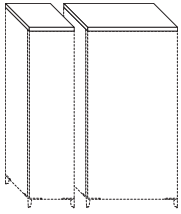

				Product No.	List \$	Product No.	List \$
Tops for Towers 54h ‡	w	d	1.5th	Detail Front Only		\$ Detail Front/Back	
TowerTop 54/15: 18	18	15.1		STB.ACB.000	828	STB.BCB.000	899
TowerTop 54/15: 36	36	15.1		STB.AFB.000	907	STB.BFB.000	985
• TowerTop 54/24: 18	18	24.1		STB.ACD.000	893	STB.BCD.000	975
TowerTop 54/24: 24	24	24.1		STB.ADD.000	926	STB.BDD.000	1005
TowerTop 54/24: 30	30	24.1		STB.AED.000	955	STB.BED.000	1038
• TowerTop 54/24: 36	36	24.1		STB.AFD.000	985	STB.BFD.000	1069

A-grade veneers on ceiling side of top.

§ Add 0.1 to depth

				Product No.	List \$	Product No.	List \$
Tops for Towers > 54h ‡	w	d	1.5th	Detail Front Only		\$ Detail Front/Back	
TowerTop 72^/15: 18	18	15.1		STA.ACB.000	296	STA.BCB.000	369
TowerTop 72^/15: 36	36	15.1		STA.AFB.000	402	STA.BFB.000	481
• TowerTop 72^/24: 18	18	24.1		STA.ACD.000	422	STA.BCD.000	494
TowerTop 72^/24: 24	24	24.1		STA.ADD.000	428	STA.BDD.000	504
• TowerTop 72^/24: 36	36	24.1		STA.AFD.000	435	STA.BFD.000	515

Secondary grade veneers on ceiling side of top.

§ Add 0.1 to depth

+ Options (for Tower Tops)

For a solid color finish, change the last digit to 1.

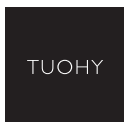

Specify: Product Number  
 Quantity  
 Tagging  
 Wood Finish  
 Hardware Finish

• Denotes item illustrated  
 ‡ Requires field sub-assembly

Prices listed in Wood1 Finishes.

