

XPECT COLLECTION
SPECIFICATION GUIDE & LIST PRICES

04.15.12

TUOHY

XPECT COLLECTION

TYPICALS	310	BOOKCASES	324
INTRODUCTION	312	PEDESTALS	324
TABLE-DESKS	314	HUTCHES	328
DESKS	315	WALL HUTCHES	331
RUNOFFS	318	HUTCHES, SLIDING GLASS DOORS	332
BRIDGES	320	HUTCH SHELVES	335
DIVIDER PANELS	321	FABRIC PANELS, WALL HUNG	335
SURROUND PANELS	321	WALL PANELS	336
CREDENZA TOPS	322	WALL PANEL SHELVES	336
TOP-TO-TOWER CONNECTOR	322	TOWERS	337
TOP SUPPORT KEELS	323		
POST-LEGS	323		
BASE L/T PANELS	323		
MODESTY PANELS	324		

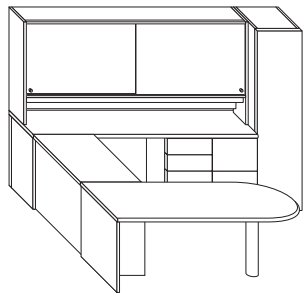

X-A

- Hutch72: Sliding2 90, Fabric Back Panel
- Tower 72/24: Cabinet RH 18
- CredenzaTop24: 90
- Base L-Panel LH 18x24, Unfinished Back
- Ped24: 2BF 18, Unfinished Back
- Ped24: 2F 18, Unfinished Back
- Bridge24: 48
- Computer Corner Adapter Top
- Desk/Bullet: Post-TBase 72x36

Product Number	List Price	Qty
LLQF-90-15-72	5707	1
LPC-18-24-72	2287	1
LF-90-24	1088	1
LHLU-18-24	472	1
LKFU-18-24	1593	1
LKEU-18-24	1482	1
LCF-48-24	1400	1
LE-12-12	209	1
LACJ-72-36	2933	1

Total: 17171

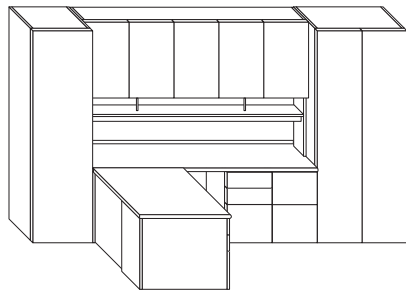

X-B

- Tower 85/24: Garment LH 24
- Hutch85: Cabinet2 90, Fabric Back Panel
- Hutch Shelf 90 for Standard Hutch
- Tower 85/24: Cabinet DBL 36
- CredenzaTop24: 90
- Base L-Panel LH 36x24
- Modesty-Panel: 18
- Ped24: 2F 18, Unfinished Back
- Ped24: 2BF 18, Unfinished Back
- Runoff36 Top: LH 54
- Modesty-Panel: 36 Finished Back
- Ped36: 2BF 18 Finished Back

LPE-24-24-85	2696	1
LLHF-90-15-85	3969	1
LLWS-90-15	754	1
LPD-36-24-85	3843	1
LF-90-24	1088	1
LHLU-36-24	531	1
LJU-18	352	1
LKEU-18-24	1482	1
LKFU-18-24	1593	1
LBA-54-36	1157	1
LJF-36	462	1
LKFF-18-36	1973	1

Total: 19900

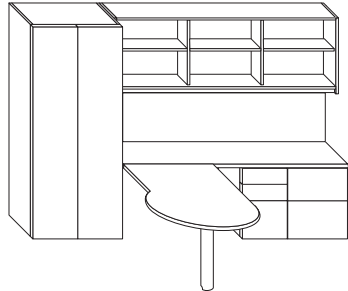

X-C

- Tower 85/24: Garment: Cab 36
- WallHutch: WoodShelf2 90
- Fabric Wall Panel: 90 for Wall Hutch
- CredenzaTop24: 90
- Ped24: 2BF 18, Unfinished Back
- Ped24: 2LatF 30, Unfinished Back
- Top-to-Tower Connector
- Runoff36/P: Post-Leg LH 66

LPH-36-24-85	4342	1
LME-90-15-30.6	2637	1
LN-90-23.4	545	1
LF-90-24	1088	1
LKFU-18-24	1883	1
LKEU-30-24	1719	1
LFB	40	1
LBD-66-36	3018	1

Total: 15272

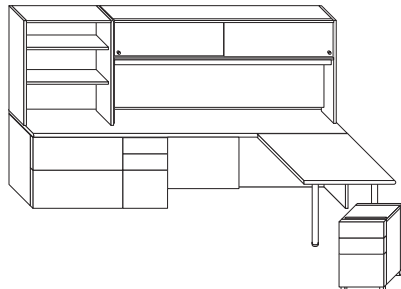

X-D

- Hutch72: WoodShelving3 36
- Hutch72: Sliding1 90 2 Doors, Fabric BP
- Hutch Shelf 90 for Standard Hutch
- CredenzaTop24: 126
- Ped24: 2LatF 36, Unfinished Back
- Ped24: 2BF 18, Unfinished Back
- PedMobile18: 2BF 18
- Modesty-Panel: 36
- Credenza Support Keel: 70
- Base L-Panel RH 36x24, Unfinished Back
- Runoff36 Top: RH 54
- Post2 Legs

LLJ-36-15-72	1463	1
LLNF-90-15-72	4773	1
LLWS-90-15	754	1
LF-126-24	1545	1
LKEU-36-24	1819	1
LKFU-18-24	1593	1
LKFM-18-18	1760	1
LJU-36	420	1
LG-70	216	1
LHRU-36-24	531	1
LBB-54-36	1157	1
7VMUA92	515	1

Total: 16546

Specify: Product Number, Quantity
Tagging
Wood Finish
Hardware Finish
Edge Detail

Totals are extended sums.
Prices listed in Group 1 Finishes.

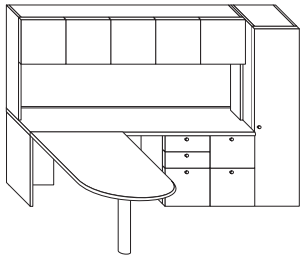

X-G

- Runoff36/Bullet: Post-Leg 60
- Base L-Panel LH 18x24
- Ped24: 2BF 18
- Ped24: 2F 18
- CredenzaTop24: 90
- Hutch72: Cabinet1 90, Wood Back Panel
- Tower 72/24: Cabinet RH 18

Product Number	List Price	Qty
LBC-60-36	2315	1
LHLU-18-24	472	1
LKFU-18-24	1593	1
LKEU-18-24	1482	1
LF-90-24	1088	1
LLBW-90-15-72	3182	1
LPC-18-24-72	2287	1
Total:	12419	

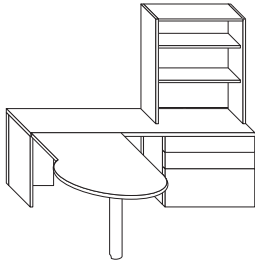

X-3

- Runoff36/P: Post-Leg LH 66
- Base L-Panel LH 18x24
- Ped24: 2LatB/LatF 36
- CredenzaTop24: 90
- Hutch72: WoodShelving3 36

LBD-66-36	3018	1
LHLU-18-24	472	1
LKFU-36-24	1990	1
LF-90-24	1088	1
LLJ-36-15-72	1463	1
Total:	8031	

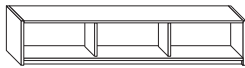

X-4

- Desk/Bullet: Post-TBase 72x36
- Bridge24: 48
- Base L-Panel LH 18x24
- Ped24: 2LatF 36
- CredenzaTop24: 90
- WallHutch: WoodShelf1 90

LACJ-72-36	2933	1
LCF-48-24	1400	1
LHLU-18-24	472	1
LKEU-36-24	1819	1
LF-90-24	1088	1
LMA-90-15-18	2103	1
Total:	9815	

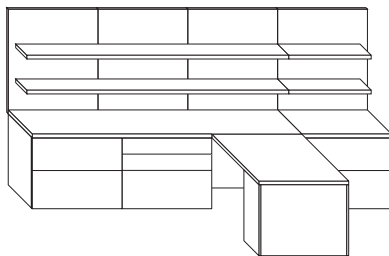

X-H

- Ped24: 2LatF 36, Unfinished Back
- Ped24: 2LatB/LatF 36, Unfinished Back
- Modesty-Access: 36
- Ped24: 2LatF 36, Unfinished Back
- CredenzaTop24: 108
- CredenzaTop24: 36
- Ped36: Cabinet RH 12, Finished Back
- Runoff Desk Top: LH 54
- Wall Panel WoodGr1 36w 1.5d x 43.6h
- Wall Panel WoodGr1 36w 1.5d x 43.6h
- Wall Panel WoodGr1 36w 1.5d x 43.6h
- Wall Panel WoodGr1 36w 1.5d x 43.6h
- Wall Panel Shelf 105w 11.25d 43.7h (3-in from LH edge)
- Wall Panel Shelf 33w 11.25d 43.7h (3-in from RH edge)
- Wall Panel Shelf 105w 11.25d 57.6h (3-in from LH edge)
- Wall Panel Shelf 33w 11.25d 57.6h (3-in from RH edge)

LKEU-36-24	1819	1
LKFU-36-24	1990	1
LJR-36	503	1
LKEU-36-24	1819	1
LF-108-24	1238	1
LF-36-24	720	1
LKCF-12-36	1510	1
LBA-54-36	1157	1
LWP72D-36	993	1
LWP72D-36	993	1
LWP72D-36	993	1
LWP72D-36	993	1
LWS105L-43.7	1061	1
LWS33R-43.7	755	1
LWS105L-57.6	1061	1
LWS33R-57.6	755	1
Total:	18360	



Specify: Product Number, Quantity
 Tagging
 Wood Finish
 Hardware Finish
 Edge Detail

Totals are extended sums.
 Prices listed in Group 1 Finishes.

HARDWARE AND EDGES

Knob and Pull Hardware



100 Recessed Wood

575 Nickel Matte

671 Chrome Polished
673 Brass Polished
674 Black
675 Nickel Satin

820 Resin Stainless

Hardware Placement Notes

Drawer pulls will be centered on all drawer fronts, except as follows:

- 575 Pulls will be mounted LEFT on drawers faces 18-inches wide or less.
- 830 Pulls will be mounted RIGHT on drawers faces 18-inches wide or less.
- Door knobs and pulls will be mounted opposite the hinge side in all instances.



830 Resin Stainless

840 Resin Stainless

851 Chrome Polished
856 Stainless Steel

Edge Detail

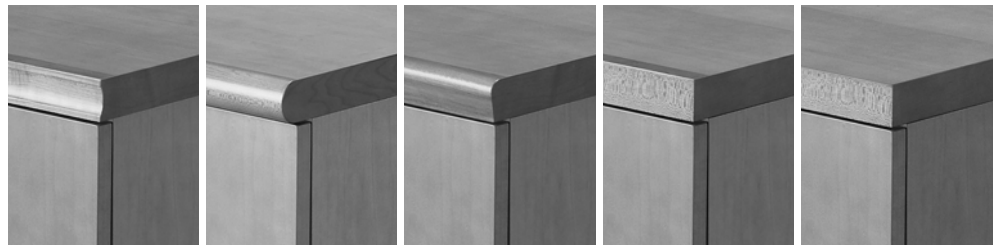

55 Concave
(0.08-in overhang)

56 Bullnose
(0.87-in overhang)

57 Soft Bevel
(0.34-in overhang)

58 Square
(0.08-in overhang)

50 Square All-Veneer
(0.08-in overhang)

Solid wood edge detail on user and visitor edges (except 50); other edges are flush-cut matching veneer. Visitor edges are those normally used with guest chairs, as on Desks and Bullet or P-Shape Runoffs. Dimensions listed in this price list do not include the edge overhang; make allowances accordingly.

OPTIONS

Wood Species/Finish

Units can be specified in standard TUOHY Wood Finishes, Solid Colors, or any combination thereof. Exotic veneers and sketch-face patterns may be applied on a quote basis.

Parametrics

Xpect products are parametrically specified. You are not restricted to the sizes listed in this price list. Call out the nominal dimension that you desire, TUOHY will calculate the appropriate edge overhangs based upon the style you select. There is no surcharge, just use the price for the next larger unit.

Example: LAAA-76-34 is a 76 wide x 34 deep rectangular 2 box/file-2 box/file desk. The price would be the same as a LAAA-78-36, which is the next size larger in both width and depth.

The following dimensions are fixed and cannot be changed:

Pedestal heights are 28.4 inches tall

Drawer style pedestals are available in 18, 30, 36 inches widths only.

Lap Drawers

Finishes Available:

Lap Drawer 24 inch Face	All TUOHY Hardwood Colors (Face only)	L70MKA00	540
Lap Drawer 24 inch Face w. Liner	All TUOHY Hardwood Colors (Face only)	L70MKA01	641
Lap Dwr Rear Fascia-4 ft/Field Cut	All TUOHY Hardwood Colors	L70PCF00	229
Lap Drawer 24 inch Face, Encased	All TUOHY Hardwood Colors (Face+case)	L70MKA02	799

ADDITIONAL NOTES

- ! All dimensions are nominal.
- ! All prices are based on Group 1 finishes and include freight.
- ! All drawer pedestals are standard with locks. Locks are optional on Hutches and Towers.
- ! Towers, Peds: Unfinished Back-ends overlay the back; Finished Back-back overlaying the ends.
- ! Refer to the General Information section of the TUOHY List Price Schedule for additional specification information, Terms & Conditions, and Warranty.
- ! Refer also to the TUOHY List Price Schedule for a complete list of additional options, including:
 Power Management Undershelf Lights Locks Pencil Trays Keyboard Mechanisms



Table-Desks

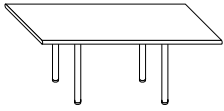

	w	d	29.9h	Open Leg	Product Number	List \$	Product Number	List \$
Table Rectangle 60x24	60	24		Open Leg	LQCG-60-24	2264		
Table Rectangle 60x30	60	30			LQCG-60-30	2304		
Table Rectangle 66x30	66	30			LQCG-66-30	2353		
Table Rectangle 72x30	72	30			LQCG-72-30	2400		
Table Rectangle 78x30	78	30			LQCG-78-30	2451		
Table Rectangle 60x36	60	36			LQCG-60-36	2547		
Table Rectangle 66x36	66	36			LQCG-66-36	2618		
• Table Rectangle 72x36	72	36			LQCG-72-36	2690		
Table Rectangle 78x36	78	36			LQCG-78-36	2758		

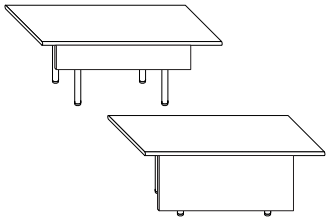

	w	d	29.9h	Half Modesty Panel	Full Modesty Panel		
Table/Modesty Rectangle 60x24	60	24		LQCJ-60-24	2456	LQCH-60-24	2504
Table/Modesty Rectangle 60x30	60	30		LQCJ-60-30	2499	LQCH-60-30	2547
Table/Modesty Rectangle 66x30	66	30		LQCJ-66-30	2552	LQCH-66-30	2602
Table/Modesty Rectangle 72x30	72	30		LQCJ-72-30	2605	LQCH-72-30	2656
Table/Modesty Rectangle 78x30	78	30		LQCJ-78-30	2666	LQCH-78-30	2719
Table/Modesty Rectangle 60x36	60	36		LQCJ-60-36	2739	LQCH-60-36	2787
Table/Modesty Rectangle 66x36	66	36		LQCJ-66-36	2818	LQCH-66-36	2868
• Table/Modesty Rectangle 72x36	72	36		LQCJ-72-36	2895	LQCH-72-36	2947
Table/Modesty Rectangle 78x36	78	36		LQCJ-78-36	2972	LQCH-78-36	3025

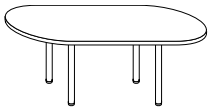

	w	d	29.9h	Open Leg		
Table Track 72x30	72	30		LQFG-72-30	4335	
Table Track 78x30	78	30		LQFG-78-30	4414	
• Table Track 72x36	72	36		LQFG-72-36	4414	
Table Track 78x36	78	36		LQFG-78-36	4493	

+ Options/Parametrics:

Width range: 60-78

Depth range: 24-36

Finish variables are top, modesty panel.

! Notes:

Tops are 1.5 inches thick; specify any Xpect edge detail.

Leg finish is Resin Brushed Aluminum.

Specify: Product Number, Quantity
Tagging
Wood Finish
Hardware Finish
Edge Detail

- Denotes Item is illustrated.
- ‡ Requires field sub-assembly.

Prices listed in Wood1 Finishes.

Desks, Double Pedestal

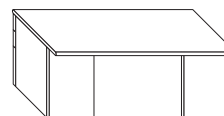
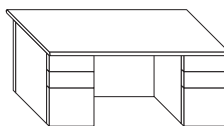
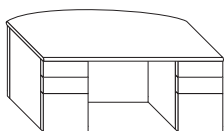
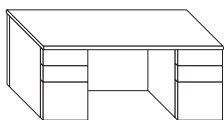

Rectangular Top ↯	w	d	29.9h		
Desk 60x24	60	24		LAA?-60-24	3888
Desk 60x30	60	30		LAA?-60-30	4091
Desk 66x30	66	30		LAA?-66-30	4159
Desk 72x30	72	30		LAA?-72-30	4237
Desk 78x30	78	30		LAA?-78-30	4300
Desk 84x30	84	30		LAA?-84-30	4387
Desk 60x36	60	36		LAA?-60-36	4324
Desk 66x36	66	36		LAA?-66-36	4395
• Desk 72x36	72	36		LAA?-72-36	4487
Desk 78x36	78	36		LAA?-78-36	4562
Desk 84x36	84	36		LAA?-84-36	4660
Desk 90x36	90	36		LAA?-90-36	4754

D-Top ↯	w	d	29.9h		
Desk/D 60x24	60	30		LAB?-60-24	4298
Desk/D 60x30	60	36		LAB?-60-30	4499
Desk/D 66x30	66	36		LAB?-66-30	4572
Desk/D 72x30	72	36		LAB?-72-30	4661
Desk/D 78x30	78	36		LAB?-78-30	4730
Desk/D 84x30	84	36		LAB?-84-30	4823
Desk/D 60x36	60	42		LAB?-60-36	4754
Desk/D 66x36	66	42		LAB?-66-36	4837
• Desk/D 72x36	72	42		LAB?-72-36	4934
Desk/D 78x36	78	42		LAB?-78-36	5019
Desk/D 84x36	84	42		LAB?-84-36	5125
Desk/D 90x36	90	42		LAB?-90-36	5230

Overhang-Top ↯	w	d	29.9h		
Desk/Overhang 60x30	60	36		LAE?-60-30	4140
Desk/Overhang 66x30	66	36		LAE?-66-30	4215
Desk/Overhang 72x30	72	36		LAE?-72-30	4307
Desk/Overhang 78x30	78	36		LAE?-78-30	4386
Desk/Overhang 84x30	84	36		LAE?-84-30	4485
Desk/Overhang 60x36	60	42		LAE?-60-36	4373
Desk/Overhang 66x36	66	42		LAE?-66-36	4453
• Desk/Overhang 72x36	72	42		LAE?-72-36	4558
Desk/Overhang 78x36	78	42		LAE?-78-36	4645
Desk/Overhang 84x36	84	42		LAE?-84-36	4754
Desk/Overhang 90x36	90	42		LAE?-90-36	4867

? Specify configuration (user's left-right) by modifying the Product Number:

- For 2BF-2BF, change the 4th digit from ? to A.
- For 2F-2F, change the 4th digit from ? to B.
- For 2BF-2F, change the 4th digit from ? to C.
- For 2F-2BF, change the 4th digit from ? to D.

+ Options/Parametrics:

Width range: 60-90 (peds are 18w fixed —top and modesty panel change). Ex: LAAA-62.25-30 4038

Depth range: 24-36 (drawer depths will be 20 or 30). Ex: LAAA-74-34.5 4429

Maximum of 3 surface grommets may be used; see Options and surcharges.

Finish variables are top, faces, backs, modesty panel.

! Notes:

- Modesty panel is inset 0.75 inch.
- D-Tops and Overhang-Tops have a 6 inch visitor's overhang.
- Face locks are included as standard
- Tops have Flush-Cut Ends.

Specify: Product Number, Quantity
 Tagging
 Wood Finish
 Hardware Finish
 Edge Detail

- Denotes Item is illustrated.
- ↯ Includes locks.

Prices listed in Wood1 Finishes.



Product Number List \$

Desks, Single Pedestal

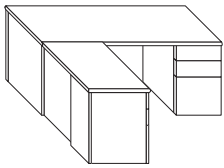

Rectangular Top ↯	w	d	29.9h		
Desk1 60x24	60	24		LAA?-60-24	3147
Desk1 60x30	60	30		LAA?-60-30	3325
Desk1 66x30	66	30		LAA?-66-30	3388
Desk1 72x30	72	30		LAA?-72-30	3466
Desk1 78x30	78	30		LAA?-78-30	3530
Desk1 60x36	60	36		LAA?-60-36	3535
Desk1 66x36	66	36		LAA?-66-36	3607
• Desk1 72x36	72	36		LAA?-72-36	3693
Desk1 78x36	78	36		LAA?-78-36	3768

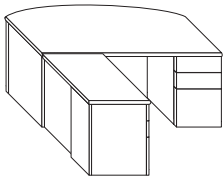

D-Top ↯	w	d	29.9h		
Desk1/D 60x30	60	36		LAB?-60-30	3734
Desk1/D 66x30	66	36		LAB?-66-30	3806
Desk1/D 72x30	72	36		LAB?-72-30	3890
Desk1/D 78x30	78	36		LAB?-78-30	3960
Desk1/D 60x36	60	42		LAB?-60-36	3535
Desk1/D 66x36	66	42		LAB?-66-36	4045
• Desk1/D 72x36	72	42		LAB?-72-36	4141
Desk1/D 78x36	78	42		LAB?-78-36	4223

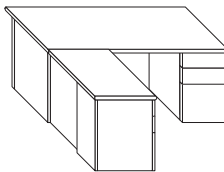

Overhang-Top ↯	w	d	29.9h		
Desk1/Overhang 60x30	60	36		LAE?-60-30	3374
Desk1/Overhang 66x30	66	36		LAE?-66-30	3446
Desk1/Overhang 72x30	72	36		LAE?-72-30	3536
Desk1/Overhang 78x30	78	36		LAE?-78-30	3612
Desk1/Overhang 60x36	60	42		LAE?-60-36	3584
Desk1/Overhang 66x36	66	42		LAE?-66-36	3665
• Desk1/Overhang 72x36	72	42		LAE?-72-36	3763
Desk1/Overhang 78x36	78	42		LAE?-78-36	3852

? Specify configuration (user's left-right) by modifying the Product Number:

- For LBase-2BF, change the 4th digit from ? to E.
- For LBase-2F, change the 4th digit from ? to F.
- For 2BF-LBase, change the 4th digit from ? to G.
- For 2F-LBase, change the 4th digit from ? to H.

+ Options/Parametrics:

- Width range: 60-78, peds are 18 inches fixed width—top and modesty panel change.
- Depth range: 24-36, drawer depths will be 20 or 30.
- Maximum of 3 surface grommets may be used; see Options and surcharges.
- Finish variables are top, faces, backs, modesty panel.

! Notes:

- Modesty panel is inset 0.75 inch.
- D-Tops and Overhang-Tops have a 6 inch front (visitor's) overhang.
- Face locks are included as standard
- Tops have Flush-Cut Ends.

Specify: Product Number, Quantity
Tagging
Wood Finish
Hardware Finish
Edge Detail

- Denotes Item is illustrated.
- ↯ Includes locks.

Prices listed in Wood1 Finishes.

Product Number List \$

Desks, Bullet-Top

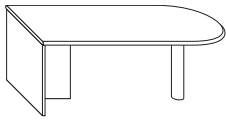

Post-Leg & T-Base ‡	w	d	29.9h		
Desk/Bullet: Post-TBase 60x24	60	24		LACJ-60-24	2499
Desk/Bullet: Post-TBase 66x30	66	30		LACJ-66-30	2749
Desk/Bullet: Post-TBase 72x30	72	30		LACJ-72-30	2804
• Desk/Bullet: Post-TBase 72x36	72	36		LACJ-72-36	2933
Desk/Bullet: Post-TBase 78x36	78	36		LACJ-78-36	2986
Desk/Bullet: Post-TBase 84x36	84	36		LACJ-84-36	3072

+ Options/Parametrics:

Width range: 60-84

Depth range: 24-36

Metal post leg is available in MRB Resin Black or MRS Resin Silver.

Finish variable is the top.

Desks, P-Top

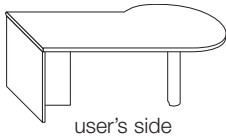

Post & T-Base ‡	w	d	29.9h		
Desk/P: Post-TBase 60x24	60	30		LADK-60-24	3106
Desk/P: Post-TBase 66x30	66	36		LADK-66-30	3339
Desk/P: Post-TBase 72x30	72	36		LADK-72-30	3361
Desk/P: Post-TBase 72x36	72	42		LADK-72-36	3659
Desk/P: Post-TBase 78x36	78	42		LADK-78-36	3683
Desk/P: Post-TBase 84x36	84	42		LADK-84-36	3730
Desk/P: TBase-Post 60x24	60	30		LADJ-60-24	3106
Desk/P: TBase-Post 66x30	66	36		LADJ-66-30	3339
Desk/P: TBase-Post 72x30	72	36		LADJ-72-30	3361
• Desk/P: TBase-Post 72x36	72	42		LADJ-72-36	3659
Desk/P: TBase-Post 78x36	78	42		LADJ-78-36	3683
Desk/P: TBase-Post 84x36	84	42		LADJ-84-36	3730

+ Options/Parametrics:

Width range: 60-84

Depth range: 24-42

Metal post leg is available in MRB Resin Black or MRS Resin Silver.

Finish variable is the top.

! Notes (all items this page):

Tops have a Flush-Cut End.



Specify: Product Number, Quantity
 Tagging
 Wood Finish
 Hardware Finish
 Edge Detail

• Denotes Item is illustrated.
 ‡ Requires field sub-assembly.

Prices listed in Wood1 Finishes.

Runoffs, Rectangular Top Only

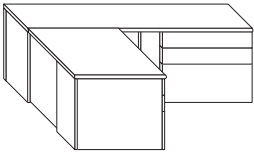
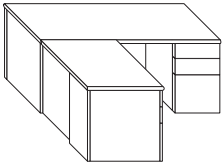
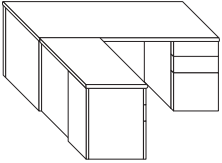
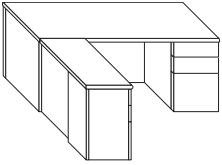

Product Number List \$ Product Number List \$

Credenza Depths	w	1.5th	18d Top		24d Top	
Runoff Cred Top: LH 42	42		LBA-42-18	838	LBA-42-24	905
Runoff Cred Top: LH 48	48		LBA-48-18	879	LBA-48-24	951
• Runoff Cred Top: LH 54	54		LBA-54-18	908	LBA-54-24	989
Runoff Cred Top: LH 60	60		LBA-60-18	942	LBA-60-24	1053
Runoff Cred Top: LH 72	72		LBA-72-18	1017	LBA-72-24	1134
Runoff Cred Top: LH 84	84		LBA-84-18	1096	LBA-84-24	1235
Runoff Cred Top: LH 90	90		LBA-90-18	1189	LBA-90-24	1327
Runoff Cred Top: LH 108	108		LBA-108-18	1337	LBA-108-24	1472
Runoff Cred Top: LH 120	120		LBA-120-18	1467	LBA-120-24	1605
Runoff Cred Top: RH 42	42		LBB-42-18	838	LBB-42-24	905
Runoff Cred Top: RH 48	48		LBB-48-18	879	LBB-48-24	951
Runoff Cred Top: RH 54	54		LBB-54-18	908	LBB-54-24	989
Runoff Cred Top: RH 60	60		LBB-60-18	942	LBB-60-24	1053
Runoff Cred Top: RH 72	72		LBB-72-18	1017	LBB-72-24	1134
Runoff Cred Top: RH 84	84		LBB-84-18	1096	LBB-84-24	1235
Runoff Cred Top: RH 90	90		LBB-90-18	1189	LBB-90-24	1327
Runoff Cred Top: RH 108	108		LBB-108-18	1337	LBB-108-24	1472
Runoff Cred Top: RH 120	120		LBB-120-18	1467	LBB-120-24	1605

Desk Depths	w	1.5th	30d Top		36d Top	
Runoff Desk Top: LH 42	42		LBA-42-30	966	LBA-42-36	1030
Runoff Desk Top: LH 48	48		LBA-48-30	1025	LBA-48-36	1096
• Runoff Desk Top: LH 54	54		LBA-54-30	1073	LBA-54-36	1157
Runoff Desk Top: LH 60	60		LBA-60-30	1117	LBA-60-36	1238
Runoff Desk Top: LH 72	72		LBA-72-30	1246	LBA-72-36	1364
Runoff Desk Top: LH 84	84		LBA-84-30	1371	LBA-84-36	1490
Runoff Desk Top: LH 90	90		LBA-90-30	1463	LBA-90-36	1600
Runoff Desk Top: LH 108	108		LBA-108-30	1610	LBA-108-36	1747
Runoff Desk Top: LH 120	120		LBA-120-30	1741	LBA-120-36	1882
Runoff Desk Top: RH 42	42		LBB-42-30	966	LBB-42-36	1030
Runoff Desk Top: RH 48	48		LBB-48-30	1025	LBB-48-36	1096
Runoff Desk Top: RH 54	54		LBB-54-30	1073	LBB-54-36	1157
Runoff Desk Top: RH 60	60		LBB-60-30	1117	LBB-60-36	1238
Runoff Desk Top: RH 72	72		LBB-72-30	1246	LBB-72-36	1364
Runoff Desk Top: RH 84	84		LBB-84-30	1371	LBB-84-36	1490
Runoff Desk Top: RH 90	90		LBB-90-30	1463	LBB-90-36	1600
Runoff Desk Top: RH 108	108		LBB-108-30	1610	LBB-108-36	1747
Runoff Desk Top: RH 120	120		LBB-120-30	1741	LBB-120-36	187

+ Options/Parametrics:
Width range: 18-120
Depth range: 18-36

! Notes:

See page 321 for Post-Legs that may be used with Runoff Tops shown above.

The recommended maximum open span under tops is 54 inches use legs, bases & pedestals accordingly.

Tops are Edge Detail Front Only (Flush-Cut End/Back).

Specify: Product Number, Quantity
Tagging
Wood Finish
Hardware Finish
Edge Detail

• Denotes Item is illustrated.
Prices listed in Wood1 Finishes.

Product Number List \$

Runoffs, Rectangular Top Only (cont.)

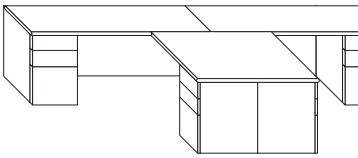

48d Top	w	48d 1.5th		
Runoff48 Top: LH 42	42		LBA-42-48	1084
Runoff48 Top: LH 48	48		LBA-48-48	1128
• Runoff48 Top: LH 54	54		LBA-54-48	1170
Runoff48 Top: LH 60	60		LBA-60-48	1214
Runoff48 Top: LH 72	72		LBA-72-48	1321
Runoff48 Top: LH 84	84		LBA-84-48	1406

+ Options/Parametrics:

Width range: 42-84
Depth range: 36-48

! Notes:

See page 321 for Post-Legs that may be used with Runoff Tops shown above.
The maximum open span under tops is 54 inches; use legs, bases and pedestals accordingly.
Tops have Edge Detail Front and Back (Flush-Cut End).

Runoffs, Bullet-Shape

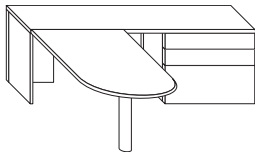

30d Bullet w. Post-Leg ‡	w	30d 29.9h		
Runoff30/Bullet: Post-Leg 48	48		LBC-48-30	2094
Runoff30/Bullet: Post-Leg 54	54		LBC-54-30	2142
Runoff30/Bullet: Post-Leg 60	60		LBC-60-30	2196
Runoff30/Bullet: Post-Leg 66	66		LBC-66-30	2242
Runoff30/Bullet: Post-Leg 72	72		LBC-72-30	2302

+ Options/Parametrics:

Width range: 48-72
Depth range: 30-36

Metal post leg is available in MRB Resin Black or MRS Resin Silver.

Runoffs, P-Shape

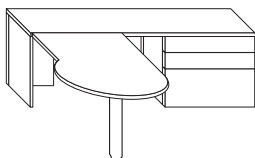

36d P-Shape w. Post-Leg ‡	w	36d 29.9h		
Runoff30/P: Post-Leg LH 66	66		LBD-66-30	2886
Runoff30/P: Post-Leg LH 72	72		LBD-72-30	2949
Runoff30/P: Post-Leg RH 66	66		LBE-66-30	2886
Runoff30/P: Post-Leg RH 72	72		LBE-72-30	2949

+ Options/Parametrics:

Width range: 48-72
Depth range: 30-36

Metal post leg is available in MRB Resin Black or MRS Resin Silver.

Specify: Product Number, Quantity
Tagging
Wood Finish
Hardware Finish
Edge Detail

• Denotes Item is illustrated.
‡ Requires field sub-assembly.

Prices listed in Wood1 Finishes.



Bridges

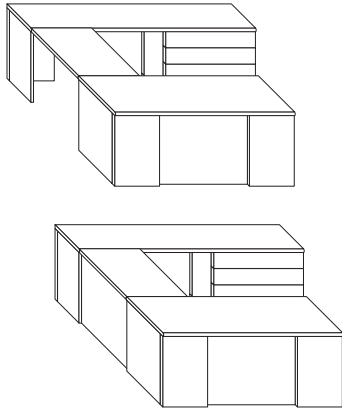

		Product Number	List \$	Product Number	List \$
18d ‡	w 18d 29.9h	Top Only		With Fixed Panel	
Bridge18: 36	36	LCD-36-18	862	LCF-36-18	1188
Bridge18: 42	42	LCD-42-18	898	LCF-42-18	1246
Bridge18: 48	48	LCD-48-18	939	LCF-48-18	1318
Bridge18: 54	54	LCD-54-18	969	LCF-54-18	1381
24d ‡	w 24d 29.9h				
Bridge24: 36	36	LCD-36-24	925	LCF-36-24	1251
Bridge24: 42	42	LCD-42-24	965	LCF-42-24	1316
• Bridge24: 48	48	LCD-48-24	1017	LCF-48-24	1400
Bridge24: 54	54	LCD-54-24	1059	LCF-54-24	1469
30d ‡	w 30d 29.9h				
Bridge30: 36	36	LCD-36-30	985	LCF-36-30	1313
Bridge30: 42	42	LCD-42-30	1036	LCF-42-30	1384
Bridge30: 48	48	LCD-48-30	1095	LCF-48-30	1480
Bridge30: 54	54	LCD-54-30	1146	LCF-54-30	1556

- + Options/Parametrics:
Width range: 36-54
Depth range: 18-30
Finish variables are top, mod panel.

! Notes:

Finished modesty panel.
Width is nominal; accommodates hutch sitting on desk-bridge-credenza combination.
Modesty panel is designed to screw to two L-Panels.
Tops have Edge Detail Front Only.

Bridges, Removable Access Panel

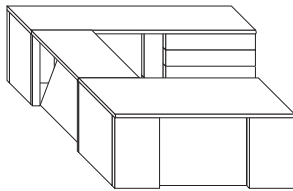

18d ‡	w 18d 29.9h	Unfinished Back	
Bridge18/Access: 36	36	LCR-36-18	1311
Bridge18/Access: 42	42	LCR-42-18	1367
Bridge18/Access: 48	48	LCR-48-18	1423
Bridge18/Access: 54	54	LCR-54-18	1472
24d ‡	w 24d 29.9h	Unfinished Back	
Bridge24/Access: 36	36	LCR-36-24	1372
Bridge24/Access: 42	42	LCR-42-24	1435
• Bridge24/Access: 48	48	LCR-48-24	1505
Bridge24/Access: 54	54	LCR-54-24	1563
30d ‡	w 30d 29.9h	Unfinished Back	
Bridge30/Access: 36	36	LCR-36-30	1435
Bridge30/Access: 42	42	LCR-42-30	1505
Bridge30/Access: 48	48	LCR-48-30	1582
Bridge30/Access: 54	54	LCR-54-30	1649

- + Options/Parametrics:
Width range: 36-54
Depth range: 18-30
Finish variables are top, access panel.

! Notes:

Unfinished back on access panel.
Width is nominal; accommodates hutch sitting on desk-bridge-credenza combination.
Access panel has 2.5 inches clearance under top.
Access panel sits out from the wall 3 inches and is attached with Velcro to two spacers.
Spacers are designed to screw between two L-Panels.
Tops have Edge Detail Front Only.

Specify: Product Number
Quantity
Tagging
Wood Finish
Edge Detail

- Denotes Item is illustrated.
- ‡ Requires field sub-assembly.

Prices listed in Wood1 Finishes.

Divider Panels

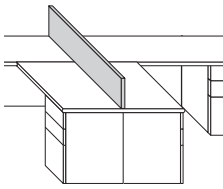

		Prod. Prefix	Width Codes and List \$											
1.5th 12.125h			18	24	30	36	45	48	54	60	72	84	90	108
Fabric-Fabric	LWDFFF		920	974	1044	1115	1210	1257	1329	1398	1540	1680	1751	1985
Glass-Glass	LWDGGG		1105	1258	1399	1540	1742	1823	1965	2105	2390	2672	2813	3259
Metal-Metal	LWDMMM		822	845	882	920	967	997	1035	1072	1149	1225	1264	1400
Wood-Fabric	LWDWFF		844	873	918	963	1021	1054	1100	1144	1236	1326	1371	1529
Wood-Glass	LWDWGG		936	1015	1095	1175	1285	1337	1418	1498	1660	1821	1902	2166
Wood-Metal	LWDWMM		794	808	836	865	898	924	954	982	1040	1098	1127	1236
Wood-Wood	LWDWWW		767	771	791	812	830	851	871	891	932	970	991	1072

> To Specify Divider Panels:

Determine the Product No. for each set by selecting the appropriate Product Prefix and appending the desired Width Code. Tag the furniture item/location that is to receive each Divider Panel.

+ Options/Parametrics:

Widths: 12-108. Replace item number width code with actual dimension use next larger std size for pricing.

! Notes:

All Divider Panels are 1.5 inches thick exposed surfaces have finished veneers.

Wood veneers are all Group 1 species and solid paint colors inquire regarding other species/colors.

Fabric is an overlay, COM selection must be suitable for vertical/panel applications.

Glass is an overlay, 4mm thick, back-painted.

Metal is an overlay, MRBS Resin Brushed Steel.

Surround Panels

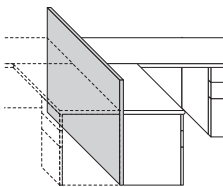

		Prod. Prefix	Width Codes and List \$											
1.5th 42h			18	24	30	36	45	48	54	60	72	84	90	108
Fabric-Fabric	LWXFF		1011	1119	1224	1332	1470	1553	1657	1765	1979	2192	2300	2673
Glass-Glass	LWXGG		1198	1366	1534	1704	1934	2049	2215	2384	2722	3060	3229	3789
Metal-Metal	LWXMM		914	988	1061	1137	1226	1293	1364	1440	1588	1737	1812	2088
Wood-Fabric	LWXWF		935	1017	1097	1179	1279	1350	1429	1511	1675	1836	1919	2217
Wood-Glass	LWXWG		1028	1140	1252	1366	1512	1599	1708	1821	2047	2271	2384	2775
Wood-Metal	LWXWM		887	952	1016	1083	1158	1221	1282	1349	1479	1609	1675	1924
Wood-Wood	LXWWW		859	916	970	1028	1090	1147	1201	1258	1370	1482	1539	1760

> To Specify Surround Panels:

Determine the Product No. for each set by selecting the appropriate Product Prefix and appending the desired Width Code. Tag the furniture item/location that is to receive each Surround Panel.

+ Options/Parametrics:

Width range: 18-108

! Notes:

All Surround Panels are 1.5 inches thick exposed surfaces have finished veneers.

Wood veneers are all Group 1 species and solid paint colors inquire regarding other species/colors.

Fabric is an overlay, COM selection must be suitable for vertical/panel applications.

Glass is an overlay, 4mm thick, back-painted.

Metal is an overlay, MRBS Resin Brushed Steel.

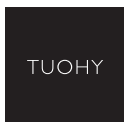

Specify: Product Number
Quantity
Tagging
Wood Finish
Edge Detail

• Denotes Item is illustrated.
‡ Requires field sub-assembly.

Prices listed in Wood1 Finishes.

Product Number List \$

Credenza Tops

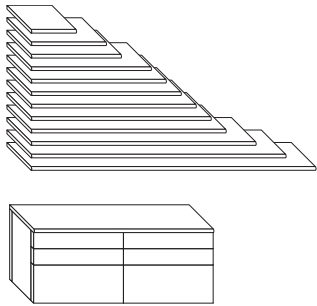

Rectangular 15d	w	15d 1.5th		
CredenzaTop15: 18	18		LF-18-15	608
CredenzaTop15: 30	30		LF-30-15	644
CredenzaTop15: 36	36		LF-36-15	671
CredenzaTop15: 48	48		LF-48-15	722
CredenzaTop15: 54	54		LF-54-15	748
CredenzaTop15: 60	60		LF-60-15	776
CredenzaTop15: 66	66		LF-66-15	800
CredenzaTop15: 72	72		LF-72-15	830
CredenzaTop15: 78	78		LF-78-15	855
CredenzaTop15: 84	84		LF-84-15	890
CredenzaTop15: 90	90		LF-90-15	917
CredenzaTop15: 108	108		LF-108-15	1018
CredenzaTop15: 120	120		LF-120-15	1074

Rectangular 24d	w	24d 1.5th		
CredenzaTop24: 18	18		LF-18-24	610
CredenzaTop24: 30	30		LF-30-24	680
CredenzaTop24: 36	36		LF-36-24	720
CredenzaTop24: 48	48		LF-48-24	798
CredenzaTop24: 54	54		LF-54-24	828
CredenzaTop24: 60	60		LF-60-24	873
CredenzaTop24: 66	66		LF-66-24	911
CredenzaTop24: 72	72		LF-72-24	955
CredenzaTop24: 78	78		LF-78-24	992
CredenzaTop24: 84	84		LF-84-24	1051
CredenzaTop24: 90	90		LF-90-24	1088
CredenzaTop24: 108	108		LF-108-24	1238
CredenzaTop24: 120	120		LF-120-24	1372

Rectangular 30d	w	30d 1.5th		
CredenzaTop30: 18	18		LF-18-30	688
CredenzaTop30: 30	30		LF-30-30	771
CredenzaTop30: 36	36		LF-36-30	810
CredenzaTop30: 48	48		LF-48-30	897
CredenzaTop30: 54	54		LF-54-30	941
CredenzaTop30: 60	60		LF-60-30	996
CredenzaTop30: 66	66		LF-66-30	1040
CredenzaTop30: 72	72		LF-72-30	1090
CredenzaTop30: 78	78		LF-78-30	1131
CredenzaTop30: 84	84		LF-84-30	1177
CredenzaTop30: 90	90		LF-90-30	1225
CredenzaTop30: 108	108		LF-108-30	1419
CredenzaTop30: 120	120		LF-120-30	1588

+ Options/Parametrics:

Width range: 18-120
Depth range: 15-30

! Notes:

This listing is of credenza tops only.
The recommended maximum open span under tops is 54 inches; use bases/pedestals accordingly.
Tops have Edge Detail Front Only.

Top-to-Tower Connector

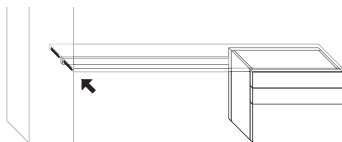

For All Top Depths ‡	1w	d	1h		
Top-to-Tower Connector		6		LFB	40

! Notes:

Pair of steel brackets in MRB Resin Black, flush-mounted to end/bottom of top.
Unsupported spans of 54 inches or more will also require a Credenza Support Keel.

Specify: Product Number
Quantity
Tagging
Wood Finish
Edge Detail

• Denotes Item is illustrated.
Prices listed in Wood1 Finishes.

Top Support Keels

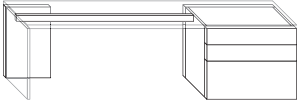

†	w	2d	1h	Product Number	List \$	Product Number	List \$
				MRB Resin Black Finish			
Top Support Keel: 52	52			LG-52	236		
Top Support Keel: 58	58			LG-58	243		
Top Support Keel: 64	64			LG-64	246		
Top Support Keel: 70	70			LG-70	250		
Top Support Keel: 82	82			LG-82	255		
• Top Support Keel: 88	88			LG-88	260		

! Notes:

Required for unsupported work surface spans of 54 inches or more.
Unit is a MRB Resin Black, 1 x 2 steel tube screwed to the underside of the work surface.

Post-Legs



For Credenza and Runoff Tops	w	d	28.4h		
Post-Legs (Pair)	2.2	Diam		7VMUA92	515

! Notes:

Remember when using Post-Legs that the maximum unsupported work surface span is 54 inches.
Metal finish is MRBA Resin Brushed Aluminum.
Includes wire management.

Base L/T Panels

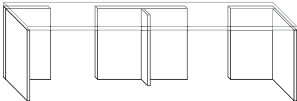

L-Panel LH †	w	d	28.4h	Unfinished Back	Finished Back
Base L-Panel LH 18x15	18	15		LHLU-18-15	LHLF-18-15
• Base L-Panel LH 18x24	18	24		LHLU-18-24	LHLF-18-24
Base L-Panel LH 18x30	18	30		LHLU-18-30	LHLF-18-30
Base L-Panel LH 18x36	18	36		LHLU-18-36	LHLF-18-36
Base L-Panel LH 24x15	24	15		LHLU-24-15	LHLF-24-15
Base L-Panel LH 24x24	24	24		LHLU-24-24	LHLF-24-24
Base L-Panel LH 24x30	24	30		LHLU-24-30	LHLF-24-30
Base L-Panel LH 24x36	24	36		LHLU-24-36	LHLF-24-36
Base L-Panel LH 36x15	36	15		LHLU-36-15	LHLF-36-15
Base L-Panel LH 36x24	36	24		LHLU-36-24	LHLF-36-24
Base L-Panel LH 36x30	36	30		LHLU-36-30	LHLF-36-30
Base L-Panel LH 36x36	36	36		LHLU-36-36	LHLF-36-36

L-Panel RH †	w	d	28.4h	Unfinished Back	Finished Back
Base L-Panel RH 18x15	18	15		LHRU-18-15	LHRF-18-15
• Base L-Panel RH 18x24	18	24		LHRU-18-24	LHRF-18-24
Base L-Panel RH 18x30	18	30		LHRU-18-30	LHRF-18-30
Base L-Panel RH 18x36	18	36		LHRU-18-36	LHRF-18-36
Base L-Panel RH 24x15	24	15		LHRU-24-15	LHRF-24-15
Base L-Panel RH 24x24	24	24		LHRU-24-24	LHRF-24-24
Base L-Panel RH 24x30	24	30		LHRU-24-30	LHRF-24-30
Base L-Panel RH 24x36	24	36		LHRU-24-36	LHRF-24-36
Base L-Panel RH 36x15	36	15		LHRU-36-15	LHRF-36-15
Base L-Panel RH 36x24	36	24		LHRU-36-24	LHRF-36-24
Base L-Panel RH 36x30	36	30		LHRU-36-30	LHRF-36-30
Base L-Panel RH 36x36	36	36		LHRU-36-36	LHRF-36-36

T-Panel †	w	d	28.4h	Unfinished Back	Finished Back
Base T-Panel 18x9	18	9		LHTU-18-9	LHTF-18-9
• Base T-Panel 36x9	36	9		LHTU-36-9	LHTF-36-9

+ Options/Parametrics:

Width range: 15-36
Depth range: 15-36 (L-Panels); 9-18 (T-Panels)

! Notes:

Units are available LH or RH with finished or unfinished backs.

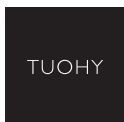

Specify: Product Number
Quantity
Tagging
Wood Finish

• Denotes Item is illustrated.
† Requires field sub-assembly.

Prices listed in Wood1 Finishes.

Modesty Panels

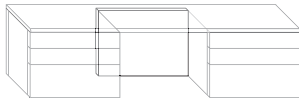

	Fixed ‡	w	1d 28.4h	Product Number	List \$	Product Number	List \$
				Unfinished Back		Finished Back	
	Modesty-Panel: 18	18		LJU-18	352	LJF-18	370
	Modesty-Panel: 24	24		LJU-24	376	LJF-24	402
	Modesty-Panel: 30	30		LJU-30	397	LJF-30	432
•	Modesty-Panel: 36	36		LJU-36	420	LJF-36	462
	Modesty-Panel: 42	42		LJU-42	438	LJF-42	493
	Modesty-Panel: 48	48		LJU-48	464	LJF-48	525
	Modesty-Panel: 54	54		LJU-54	487	LJF-54	556
	Modesty-Panel: 72	72		LJU-72	553	LJF-72	650

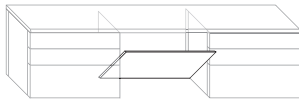

	Access/Removable ‡	w	2d 25.9h	Product Number	List \$
				Unfinished Back	
	Modesty-Access: 18	18		LJR-18	438
	Modesty-Access: 24	24		LJR-24	460
	Modesty-Access: 30	30		LJR-30	484
•	Modesty-Access: 36	36		LJR-36	503
	Modesty-Access: 42	42		LJR-42	527
	Modesty-Access: 48	48		LJR-48	552
	Modesty-Access: 54	54		LJR-54	572
	Modesty-Access: 72	72		LJR-72	636

+ Options/Parametrics:
Width range: 18-72

! Notes:

Units are exact width with two mounting strips for attachment to L-Panels or Pedestals.
Clearance on Access/Removable Panels is 2.5 inches below work surface and 3 inches from wall.

Bookcases

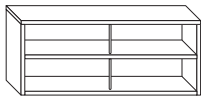

	15d 29.9h Wood Group 1	w	# Sections	Product Number	List \$	Product Number	List \$
				Unfinished Back		Finished Back	
	Bookcase 30	30	1	LKXU-30	1930	LKXF-30	2009
	Bookcase 36	36	1	LKXU-36	2013	LKXF-36	2105
	Bookcase 48	48	2	LKXU-48	2313	LKXF-48	2432
	Bookcase 54	54	2	LKXU-54	2425	LKXF-54	2556
	Bookcase 60	60	2	LKXU-60	2514	LKXF-60	2659
•	Bookcase 72	72	2	LKXU-72	2633	LKXF-72	2790
	Bookcase 81	81	3	LKXU-81	2951	LKXF-81	3135
	Bookcase 90	90	3	LKXU-90	3040	LKXF-90	3236
	Bookcase 108	108	3	LKXU-108	3320	LKXF-108	3564

! Notes:

Shelf support/dividers have a Resin Brushed Steel finish.

Pedestals, Shelving

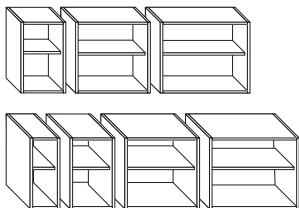

	Shelving	w	d 28.4h	Product Number	List \$	Product Number	List \$
				Unfinished Back		Finished Back	
•	Ped15: Shelving 18	18	15	LKAU-18-15	840	LKAF-18-15	874
•	Ped15: Shelving 30	30	15	LKAU-30-15	1021	LKAF-30-15	1080
•	Ped15: Shelving 36	36	15	LKAU-36-15	1115	LKAF-36-15	1182
•	Ped24: Shelving 18	18	24	LKAU-18-24	945	LKAF-18-24	977
•	Ped24: Shelving 30	30	24	LKAU-30-24	1161	LKAF-30-24	1217
•	Ped24: Shelving 36	36	24	LKAU-36-24	1275	LKAF-36-24	1342
	Ped30: Shelving 18	18	30	LKAU-18-30	1020	LKAF-18-30	1053
	Ped30: Shelving 30	30	30	LKAU-30-30	1251	LKAF-30-30	1309
	Ped30: Shelving 36	36	30	LKAU-36-30	1378	LKAF-36-30	1443
	Ped36: Shelving 18	18	36	LKAU-18-36	1095	LKAF-18-36	1128
	Ped36: Shelving 30	30	36	LKAU-30-36	1355	LKAF-30-36	1413
	Ped36: Shelving 36	36	36	LKAU-36-36	1488	LKAF-36-36	1555

+ Options/Parametrics:

Width range: 12-36
Depth range: 15-36
Finish variables are back (full units only) and shelf.

! Notes:

Units include one adjustable, removable shelf.
Units over 18 wide have inlaid bands on shelf for additional strength.
For additional flat shelves, see listing on opposite page.

Specify: Product Number • Denotes Item is illustrated.
Quantity ‡ Requires field sub-assembly.
Tagging
Wood Finish

Prices listed in Wood1 Finishes.

Pedestals, Cabinet

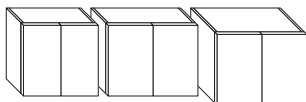
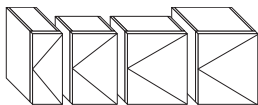

				Product Number	List \$	Product Number	List \$
LH Cabinet →	w	d	28.4h	Unfinished Back		Finished Back	
• Ped24: Cabinet LH 12	12	24		LKBU-12-24	1279	LKBF-12-24	1312
Ped30: Cabinet LH 12	12	30		LKBU-12-30	1386	LKBF-12-30	1419
Ped36: Cabinet LH 12	12	36		LKBU-12-36	1477	LKBF-12-36	1510
• Ped15: Cabinet LH 18	18	15		LKBU-18-15	1170	LKBF-18-15	1204
Ped24: Cabinet LH 18	18	24		LKBU-18-24	1251	LKBF-18-24	1283
Ped30: Cabinet LH 18	18	30		LKBU-18-30	1309	LKBF-18-30	1341
Ped36: Cabinet LH 18	18	36		LKBU-18-36	1369	LKBF-18-36	1402
• Ped15: Cabinet LH 24	24	15		LKBU-24-15	1293	LKBF-24-15	1336
• Ped24: Cabinet LH 24	24	24		LKBU-24-24	1394	LKBF-24-24	1437
Ped30: Cabinet LH 24	24	30		LKBU-24-30	1458	LKBF-24-30	1501
Ped36: Cabinet LH 24	24	36		LKBU-24-36	1527	LKBF-24-36	1570

RH Cabinet →	w	d	28.4h	Unfinished Back		Finished Back	
Ped24: Cabinet RH 12	12	24		LKCU-12-24	1279	LKCF-12-24	1312
Ped30: Cabinet RH 12	12	30		LKCU-12-30	1386	LKCF-12-30	1419
Ped36: Cabinet RH 12	12	36		LKCU-12-36	1477	LKCF-12-36	1510
Ped15: Cabinet RH 18	18	15		LKCU-18-15	1170	LKCF-18-15	1204
Ped24: Cabinet RH 18	18	24		LKCU-18-24	1251	LKCF-18-24	1283
Ped30: Cabinet RH 18	18	30		LKCU-18-30	1309	LKCF-18-30	1341
Ped36: Cabinet RH 18	18	36		LKCU-18-36	1369	LKCF-18-36	1402
Ped15: Cabinet RH 24	24	15		LKCU-24-15	1293	LKCF-24-15	1336
Ped24: Cabinet RH 24	24	24		LKCU-24-24	1394	LKCF-24-24	1437
Ped30: Cabinet RH 24	24	30		LKCU-24-30	1458	LKCF-24-30	1501
Ped36: Cabinet RH 24	24	36		LKCU-24-36	1527	LKCF-24-36	1570

Double Cabinet →	w	d	28.4h	Unfinished Back		Finished Back	
Ped15: DblCabinet 24	24	15		LKDU-24-15	1381	LKDF-24-15	1428
• Ped15: DblCabinet 30	30	15		LKDU-30-15	1471	LKDF-30-15	1523
• Ped15: DblCabinet 36	36	15		LKDU-36-15	1569	LKDF-36-15	1633
Ped24: DblCabinet 24	24	24		LKDU-24-24	1482	LKDF-24-24	1526
Ped24: DblCabinet 30	30	24		LKDU-30-24	1580	LKDF-30-24	1633
• Ped24: DblCabinet 36	36	24		LKDU-36-24	1693	LKDF-36-24	1758
Ped30: DblCabinet 24	24	30		LKDU-24-30	1545	LKDF-24-30	1590
Ped30: DblCabinet 30	30	30		LKDU-30-30	1648	LKDF-30-30	1701
Ped30: DblCabinet 36	36	30		LKDU-36-30	1771	LKDF-36-30	1835
Ped36: DblCabinet 24	24	36		LKDU-24-36	1615	LKDF-24-36	1660
Ped36: DblCabinet 30	30	36		LKDU-30-36	1725	LKDF-30-36	1776
Ped36: DblCabinet 36	36	36		LKDU-36-36	1849	LKDF-36-36	1913

+ Options/Parametrics:
Width range: 12-24 on Cabinets, 24-36 on Double Cabinets.
Depth range: 15-36
Finish variables are back, shelf, face.
For ventilation slots, specify Option VS; add \$266.

! Notes:
Locks are included on all pedestals.
Units include one adjustable, removable shelf.
Units over 18 wide have inlaid bands on shelf for additional strength.

Additional Flat Shelves

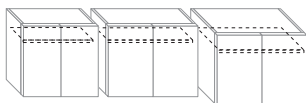

Open Shelves→	15d	24d	30d	36d
Flat Shelf 12w	LKAS-12-15 168	LKAS-12-24 184	LKAS-12-30 195	LKAS-12-36 205
Flat Shelf 18w	LKAS-18-15 181	LKAS-18-24 205	LKAS-18-30 221	LKAS-18-36 238
Flat Shelf 24w	LKAS-24-15 195	LKAS-24-24 227	LKAS-24-30 248	LKAS-24-36 270
Flat Shelf 30w	LKAS-30-15 208	LKAS-30-24 248	LKAS-30-30 275	LKAS-30-36 302
Flat Shelf 36w	LKAS-36-15 221	LKAS-36-24 270	LKAS-36-30 302	LKAS-36-36 334

+ Options/Parametrics:
For use in Cabinet units, change the 3rd digit from A to D; no price change.
! Notes:
Be sure to identify which shelving or cabinet pedestals are to receive these shelves.



Specify: Product Number
Quantity
Tagging
Wood Finish
Hardware Finish

• Denotes Item is illustrated.
Prices listed in Wood1 Finishes.

Pedestals, Drawer

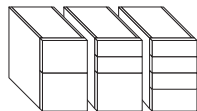
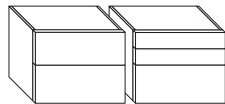
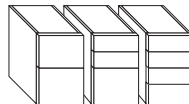
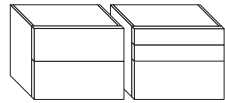
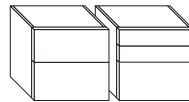
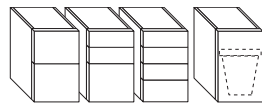
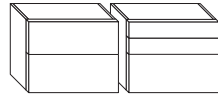
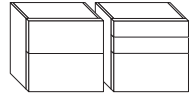
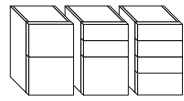

	Product Number	List \$	Product Number	List \$
18d ~ w 18d 28.4h	Unfinished Back		Finished Back	
• Ped18: 2F 18	18	LKEU-18-18	1455	LKEF-18-18 1521
• Ped18: 2BF 18	18	LKFU-18-18	1544	LKFF-18-18 1612
• Ped18: 4B 18	18	LKGU-18-18	1720	LKGF-18-18 1789
• Ped18: 2LatF 30	30	LKEU-30-18	1664	LKEF-30-18 1765
• Ped18: 2LatB/LatF 30	30	LKFU-30-18	1823	LKFF-30-18 1946
• Ped18: 2LatB/LatF 36	36	LKFU-36-18	1926	LKFF-36-18 2049

	Product Number	List \$	Product Number	List \$
24d ~ w 24d 28.4h	Unfinished Back		Finished Back	
• Ped24: 2F 18	18	LKEU-18-24	1482	LKEF-18-24 1548
• Ped24: 2BF 18	18	LKFU-18-24	1593	LKFF-18-24 1661
• Ped24: 4B 18	18	LKGU-18-24	1776	LKGF-18-24 1845
• Ped24: Trash/Recycle 18	18	LKLU-18-24	1650	LKLF-18-24 1773
• Ped24: 2LatF 30	30	LKEU-30-24	1719	LKEF-30-24 1818
• Ped24: 2LatB/LatF 30	30	LKFU-30-24	1883	LKFF-30-24 2004
• Ped24: 2LatB/LatF 36	36	LKFU-36-24	1990	LKFF-36-24 2115

	Product Number	List \$	Product Number	List \$
30d ~ w 30d 28.4h	Unfinished Back		Finished Back	
• Ped30: 2F 18	18	LKEU-18-30	1537	LKEF-18-30 1606
• Ped30: 2BF 18	18	LKFU-18-30	1655	LKFF-18-30 1721
• Ped30: 4B 18	18	LKGU-18-30	1845	LKGF-18-30 1914
• Ped30: 2LatF 30	30	LKEU-30-30	1787	LKEF-30-30 1886
• Ped30: 2LatB/LatF 30	30	LKFU-30-30	1956	LKFF-30-30 2076
• Ped30: 2LatB/LatF 36	36	LKFU-36-30	2069	LKFF-36-30 2190

	Product Number	List \$	Product Number	List \$
36d ~ w 36d 28.4h	Unfinished Back		Finished Back	
• Ped36: 2F 18	18	LKEU-18-36	1769	LKEF-18-36 1838
• Ped36: 2BF 18	18	LKFU-18-36	1906	LKFF-18-36 1973
• Ped36: 4B 18	18	LKGU-18-36	2128	LKGF-18-36 2198

+ Options/Parametrics:

Widths 18, 30 and 36 only.
Depth range: 18-36 (18w units); 18-30 (30, 36w units)
Finish variables are back, face.

! Notes:

Locks are included on all pedestals.
Drawers are 0.5 Birch with dovetailed corners.
Drawer bottoms are 0.25 inch thick dadoed into drawer sides.
Slides are ball bearing full extension.
Box drawers include drawer dividers.
File drawers include Pendaflex file hanging system.
Units through 22 deep have a 15 deep drawer with front to back filing only.
Units 22.1 through 32.9 deep have a 20 deep drawer.
Units 33 deep and more have a 30 deep drawer.

Specify: Product Number
Quantity
Tagging
Wood Finish
Hardware Finish

• Denotes Item is illustrated.
Prices listed in Wood1 Finishes.

Pedestals, Mobile

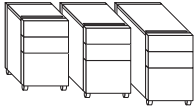

Mobile -	18w	d	27.2h	Product Number	List \$	Product Number	List \$
PedMobile18: 2BF 18		18d				LKFM-18-18	1760
PedMobile24: 2BF 18		24d				LKFM-18-24	1811
PedMobile30: 2BF 18		30d				LKFM-18-30	1870

+ Options/Parametrics:

Widths: 18 only.
 Depth range: 18-30
 Finish variables are face and back.

! Notes:

Locks are included on all pedestals.
 Drawers are 0.5 Birch with dovetailed corners.
 Drawer bottoms are 0.25 inch thick dadoed into drawer sides.
 Slides are ball bearing full extension.
 Box drawers include drawer dividers.
 File drawers include Pendaflex file hanging system.
 Units under 22 deep have a 15 deep drawer with front to back filing only.
 Units over 22 deep and under 33 deep have a 20 deep drawer.

Pedestals, Drawer/Cabinet

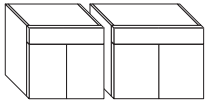

Lateral Box/ Double Cabinet -	w	d	28.4h	Unfinished Back	Finished Back
Ped18: LatB/DbiCab 30	30	18		LKHU-30-18	1725 LKHF-30-18 1776
Ped18: LatB/DbiCab 36	36	18		LKHU-36-18	1869 LKHF-36-18 1933
• Ped24: LatB/DbiCab 30	30	24		LKHU-30-24	1809 LKHF-30-24 1861
• Ped24: LatB/DbiCab 36	36	24		LKHU-36-24	1968 LKHF-36-24 2030
Ped30: LatB/DbiCab 30	30	30		LKHU-30-30	1888 LKHF-30-30 1941
Ped30: LatB/DbiCab 36	36	30		LKHU-36-30	2059 LKHF-36-30 2121

Options/Parametrics and Notes: See below.

Pedestals42, Drawer

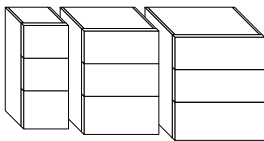

Files, Top Required -	w	d	42h	Unfinished Back
• Ped18: 3F 18	18	18		LKJU-18-18 1988
Ped18: 3LatF 30	30	18		LKJU-30-18 2305
Ped18: 3LatF 36	36	18		LKJU-36-18 2450
Ped24: 3F 18	18	24		LKJU-18-24 2026
• Ped24: 3LatF 30	30	24		LKJU-30-24 2388
Ped24: 3LatF 36	36	24		LKJU-36-24 2540
Ped30: 3F 18	18	30		LKJU-18-30 2115
Ped30: 3LatF 30	30	30		LKJU-30-30 2487
• Ped30: 3LatF 36	36	30		LKJU-36-30 2645
Ped36: 3F 18	18	36		LKJU-18-36 2462

+ Options/Parametrics:

Widths as listed only.
 Depth range: 18-36 (18w units); 18-30 (30, 36w units).
 Finish variables are back, face, shelf on units with cabinet doors, otherwise face only.
 To include Anti-Tilt Mechanisms, specify Option AT; add \$474.

! Notes:

Drawer Pedestals42 must be secured on location to the wall; otherwise, specify Option AT above.
 Locks are included on all pedestals.
 Drawers are 0.5 Birch with dovetailed corners.
 Drawer bottoms are 0.25 inch thick dadoed into drawer sides.
 Slides are ball bearing full extension.
 Box drawers include drawer dividers.
 File drawers include Pendaflex file hanging system.
 Units through 22 deep have a 15 deep drawer with front-to-back filing only.
 Units 22.1 through 32.9 deep have a 20 deep drawer.
 Units 33 deep or more have a 30 deep drawer.

Specify: Product Number
 Quantity
 Tagging
 Wood Finish
 Hardware Finish

• Denotes Item is illustrated.
 Prices listed in Wood1 Finishes.



Hutches, Wood Shelving1

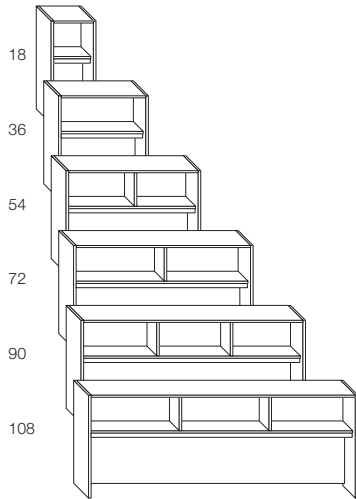

42.1h (72h installed)		w	15d	Shv	COM	Fabric Back Panel	Wood Back Panel
• Hutch72: WoodShelving1	18	18	1\0	1.3	LLAF-18-15-72	1675	LLAW-18-15-72 1281
• Hutch72: WoodShelving1	36	36	0\1	1.8	LLAF-36-15-72	1933	LLAW-36-15-72 1511
• Hutch72: WoodShelving1	54	54	1\1	2	LLAF-54-15-72	2363	LLAW-54-15-72 1914
• Hutch72: WoodShelving1	72	72	0\2	2.3	LLAF-72-15-72	2671	LLAW-72-15-72 2197
• Hutch72: WoodShelving1	90	90	1\2	2.8	LLAF-90-15-72	2975	LLAW-90-15-72 2472
• Hutch72: WoodShelving1	108	108	0\3	3.2	LLAF-108-15-72	3302	LLAW-108-15-72 2777

+ Options/Parametrics:
Width range: 18-108
Depth range: 15-18; for depths over 15 add \$1.10 per inch of width (Ex: LLAW-108-18-72 = 2896).
Height range: 36.1-42.1 (66-72 installed)

! Notes:
Units under 42.1h (72h installed) have an A grade top surface.
Units at 42.1h (72h installed) have a 3 grade top surface.
The shelving area opening remains constant at 14.6 high.
Units have an unfinished back and are designed to go up against a wall.
Fabric/Wood Back Panels are removable for wire access and management.
The back of the units have cord access slots located 2.5 up from the bottom.
The removable back panel has 0.5 clearance at the bottom and 0.75 clearance at the top.
Dividers: None through 36w; one at 36.1-72w; two at 72.1w or more.
Finish variables are back, removable back.
Fabric Panels on units over 96w are produced in two sections.

Hutches, Wood Shelving Full Height

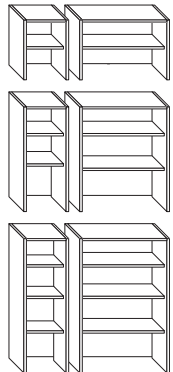

26.1h (56h installed)		w	15d	Shv	Wood Back Panel
• Hutch56: WoodShelving2	18	18	2\0		LLJ-18-15-56 938
• Hutch56: WoodShelving2	36	36	0\2		LLJ-36-15-56 1094

42.1h (72h installed)		w	15d	Shv	Wood Back Panel
• Hutch72: WoodShelving3	18	18	3\0		LLJ-18-15-72 1138
• Hutch72: WoodShelving3	36	36	0\3		LLJ-36-15-72 1463

55.1h (85h installed)		w	15d	Shv	Wood Back Panel
• Hutch85: WoodShelving4	18	18	4\0		LLJ-18-15-85 1295
• Hutch85: WoodShelving4	36	36	0\4		LLJ-36-15-85 1759

+ Options/Parametrics:
Width range: 18-36
Depth range: 15-18; for depths over 15 add \$1.65 per inch of width (Ex: LLJ-36-18-85 = 1818).
Height range: 24.1-55.1 (54-85 installed)
Finish variables are back, shelves.

! Notes:
Units under 42.1h (72h installed) have an A grade top surface.
Units 42.1h (72h installed) and higher have a 3 grade top surface.
Units have an unfinished back and are designed to go up against a wall.
Number of adjustable shelves varies approximately on 14 inch openings.
Fabric Panels on units over 96w are produced in two sections.

Specify: Product Number
Quantity
Tagging
Wood Finish

• Denotes Item is illustrated.
Prices listed in Wood1 Finishes.

Hutches, Cabinet1

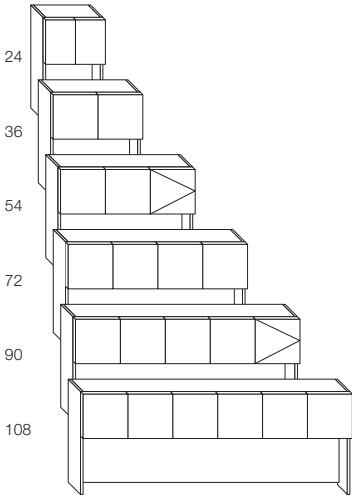

42.1h (72h installed)	w	15d	Shv	COM	Fabric Back Panel	Wood Back Panel
• Hutch72: Cabinet1 24	24	0\1	1.8	LLBF-24-15-72	2066	LLBW-24-15-72 1664
• Hutch72: Cabinet1 36	36	0\1	1.8	LLBF-36-15-72	2254	LLBW-36-15-72 1835
• Hutch72: Cabinet1 54	54	1\1	2	LLBF-54-15-72	2812	LLBW-54-15-72 2369
• Hutch72: Cabinet1 72	72	0\2	2.3	LLBF-72-15-72	3249	LLBW-72-15-72 2779
• Hutch72: Cabinet1 90	90	1\2	2.8	LLBF-90-15-72	3678	LLBW-90-15-72 3182
• Hutch72: Cabinet1 108	108	0\3	3.2	LLBF-108-15-72	4135	LLBW-108-15-72 3613

+ Options/Parametrics:

Width range: 24-108

Depth range: 15-18; for depths over 15 add \$1.10 per inch of width (Ex: LLBW-108-18-72 = 3732).

Height range: 30.1-42.1h (60-72 installed)

Finish variables are back, removable back, face.

! Notes:

Units under 42.1h (72h installed) have an A grade top surface.

Units 42.1h (72h installed) have a 3 grade top surface.

Units have an unfinished back and are designed to go up against a wall.

The shelving area opening remains constant at 14.6 high.

Units are available with either a COM fabric panel or wood panel. These panels are removable and are used to cover cord access.

The back of the units have cord access slots located 2.5 up from the bottom.

The removable back panel has 0.5 clearance at the bottom and 0.75 clearance at the top.

Units 24 through 42 wide have two doors.

Units 42.1 through 60 wide have three doors.

Units 60.1 through 78 wide have four doors.

Units 78.1 through 90 wide have five doors.

Units over 90 wide have six doors.

Fabric Panels on units over 96w are produced in two sections.

Hutches, Cabinet2

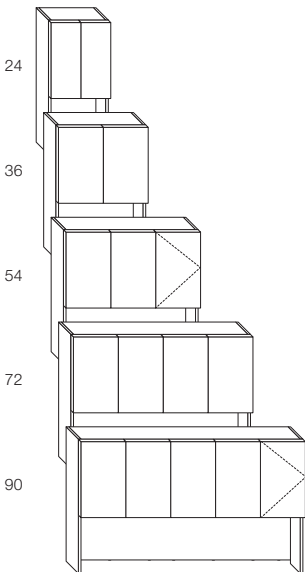

55.1h (85 installed)	w	15d	Shv	COM	Fabric Back Panel	Wood Back Panel
• Hutch85: Cabinet2 24	24	0\2	1.8	LLHF-24-15-85	2213	LLHW-24-15-85 1813
• Hutch85: Cabinet2 36	36	0\2	1.8	LLHF-36-15-85	2533	LLHW-36-15-85 2117
• Hutch85: Cabinet2 54	54	2\2	2	LLHF-54-15-85	3012	LLHW-54-15-85 2570
• Hutch85: Cabinet2 72	72	0\4	2.3	LLHF-72-15-85	3492	LLHW-72-15-85 3022
• Hutch85: Cabinet2 90	90	2\4	2.8	LLHF-90-15-85	3969	LLHW-90-15-85 3474

+ Options/Parametrics:

Width range: 24-90

Depth range: 15-18; for depths over 15 add \$2.20 per inch of width (Ex: LLHW-90-18-85 = 3672).

Height range: 50.1-55.1h (80-85 installed)

Finish variables are back, removable back, face.

! Notes:

Units have a 3 grade top surface.

Units have an unfinished back and are designed to go up against a wall.

The shelving area opening remains constant at 29.2 high.

Units are available with either a COM fabric panel or wood panel. These panels are removable and are used to cover cord access.

The back of the units have cord access slots located 2.5 up from the bottom.

The removable back panel has 0.5 clearance at the bottom and 0.75 clearance at the top.

Units 24 through 42 wide have two doors.

Units 42.1 through 60 wide have three doors.

Units 60.1 through 78 wide have four doors.

Units 78.1 through 90 wide have five doors.

Specify: Product Number
 Quantity
 Tagging
 Wood Finish

• Denotes Item is illustrated.
 Prices listed in Wood1 Finishes.

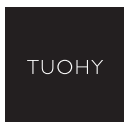

Hutches, Full Height Cabinet

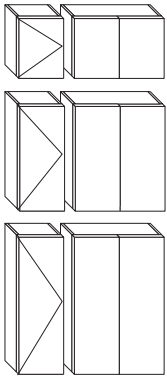

	w	15d	Shv	Product Number	List \$
26.1h (56 installed) Wood Back Panel					
Hutch56: Cabinet2 LH 18	18	2\0		LLK-18-15-56	1206
• Hutch56: Cabinet2 RH 18	18	2\0		LLL-18-15-56	1206
Hutch56: Cabinet2 36	36	0\2		LLM-36-15-56	1570
42.1h (72 installed) Wood Back Panel					
Hutch72: Cabinet3 LH 18	18	3\0		LLK-18-15-72	1444
• Hutch72: Cabinet3 RH 18	18	3\0		LLL-18-15-72	1444
• Hutch72: Cabinet3 36	36	0\3		LLM-36-15-72	1988
55.1h (85 installed) Wood Back Panel					
Hutch85: Cabinet4 LH 18	18	4\0		LLK-18-15-85	1638
• Hutch85: Cabinet4 RH 18	18	4\0		LLL-18-15-85	1638
• Hutch85: Cabinet4 36	36	0\4		LLM-36-15-85	2353

+ Options/Parametrics:

Width range: 18-36

Depth range: 15-18; for depths over 15 add \$1.65 per inch of width (Ex: LLM-36-18-85 = 2412).

Height range: 24.1-55.1 (54-85 installed)

Finish variables are back, face.

! Notes:

Units under 42.1h (72h installed) have an A grade top surface.

Units 42.1h (72h installed) and higher have a 3 grade top surface.

Units have an unfinished back and are designed to go up against a wall.

Number of adjustable shelves varies approximately on 14 inch openings.

Specify: Product Number
Quantity
Tagging
Wood Finish

• Denotes Item is illustrated.
Prices listed in Wood1 Finishes.

Wall Hutches, Shelving & Cabinet

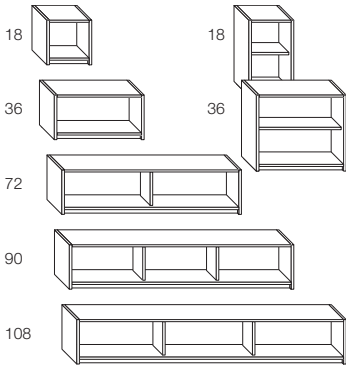

18h (Wall Cleat Included)	w	15dSgl\Tbl Shelf	Wall Hutch	Product Number	List \$
• WallHutch: WoodShelf1 18	18	1\0	LMA-18-15-18	918	
• WallHutch: WoodShelf1 36	36	0\1	LMA-36-15-18	1142	
• WallHutch: WoodShelf1 72	72	0\2	LMA-72-15-18	1808	
• WallHutch: WoodShelf1 90	90	0\3	LMA-90-15-18	2103	
• WallHutch: WoodShelf1 108	108	0\3	LMA-108-15-18	2467	
30.6h (Wall Cleat Included)	w	15dSgl\Tbl Shelf	Wall Hutch	Product Number	List \$
• WallHutch: WoodShelf2 18	18	2\0	LME-18-15-30.6	1158	
• WallHutch: WoodShelf2 36	36	0\2	LME-36-15-30.6	1456	
• WallHutch: WoodShelf2 72	72	0\4	LME-72-15-30.6	2243	
• WallHutch: WoodShelf2 90	90	0\6	LME-90-15-30.6	2637	

+ Options/Parametrics:

Width range: 18-108 for WoodShelf1, 18-90 for WoodShelf2
 Depth range: 15-18; for depths over 15 add \$1.10 per inch of width (Ex: LME-90-18-30.6 = 2736).
 Heights are fixed at 18 or 30.6
 Finish variable is the back.

! Notes:

Units have a 2 grade top surface.
 Dividers: None through 36w; one at 36.1-72w; two at 72.1w or more.
 Wall-mount cleats are included for field installation; wall hutches must be screwed through the back into the wall cleat.

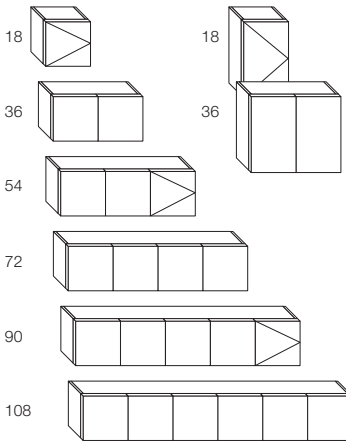

18h (Wall Cleat Included)	w	15dSgl\Tbl Shelf	Wall Hutch	Product Number	List \$
• WallHutch: Cabinet1 LH 18	18	1\0	LMC-18-15-18	1039	
• WallHutch: Cabinet1 RH 18	18	1\0	LMD-18-15-18	1039	
• WallHutch: Cabinet1 36	36	0\1	LMB-36-15-18	1544	
• WallHutch: Cabinet1 54	54	1\1	LMB-54-15-18	2071	
• WallHutch: Cabinet1 72	72	0\2	LMB-72-15-18	2501	
• WallHutch: Cabinet1 90	90	1\2	LMB-90-15-18	2931	
• WallHutch: Cabinet1 108	108	0\3	LMB-108-15-18	3378	
30.6h (Wall Cleat Included)	w	15dSgl\Tbl Shelf	Wall Hutch	Product Number	List \$
• WallHutch: Cabinet2 LH 18	18	2\0	LMF-18-15-30.6	1394	
• WallHutch: Cabinet2 RH 18	18	2\0	LMG-18-15-30.6	1394	
• WallHutch: Cabinet2 36	36	0\2	LMH-36-15-30.6	1841	
• WallHutch: Cabinet2 54	54	2\2	LMH-54-15-30.6	2471	
• WallHutch: Cabinet2 72	72	0\4	LMH-72-15-30.6	3018	
• WallHutch: Cabinet2 90	90	2\4	LMH-90-15-30.6	3560	

+ Options/Parametrics:

Width range: 18-108 for Cabinet 1, 18-90 for Cabinet 2.
 Depth range: 15-18; for depths over 15 add \$1.10 per inch of width (Ex: LMH-90-18-30.6 = 3659).
 Heights are fixed at 18 and 30.6.
 Finish variables are back, removable back, face.

! Notes:

Units have a 2 grade top surface.
 Wall-mount cleats are included for field installation; hutches must be screwed through the back into the wall cleat.
 Units 24 through 42 have two doors.
 Units 42.1 through 60 have three doors.
 Units 60.1 through 78 have four doors.
 Units 78.1 through 90 have five doors.
 Units over 90 wide have six doors.

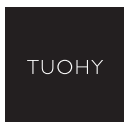

Specify: Product Number
 Quantity
 Tagging
 Wood Finish

• Denotes Item is illustrated.
 Prices listed in Wood1 Finishes.

Hutches, Sliding Glass Doors 72/1

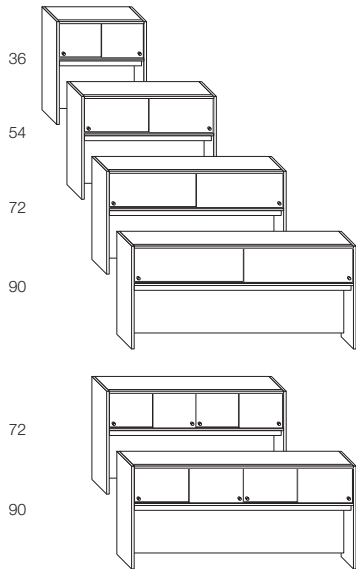

42.1h (72h installed)	w	15d	Shv	COM	Fabric Back Panel	Wood Back Panel
• Hutch72: Sliding1 36 2 Doors	36		1x1	1.8	LLNF-36-15-72 2850	LLNW-36-15-72 2428
• Hutch72: Sliding1 54 2 Doors	54		1x2	2	LLNF-54-15-72 3804	LLNW-54-15-72 3355
• Hutch72: Sliding1 72 2 Doors	72		1x2	2.3	LLNF-72-15-72 4290	LLNW-72-15-72 3814
• Hutch72: Sliding1 72 4 Doors	72		1x2	2.3	LLPF-72-15-72 4498	LLPW-72-15-72 4024
• Hutch72: Sliding1 90 2 Doors	90		1x2	2.8	LLNF-90-15-72 4773	LLNW-90-15-72 4272
• Hutch72: Sliding1 90 4 Doors	90		1x2	2.8	LLPF-90-15-72 4981	LLPW-90-15-72 4477

+ Options/Parameters:
Width range: 30-90
Depth range: 15-18; for depths over 15 add \$1.10 per inch of width (Ex: LLPW-90-18-72 = 4576).
Height range: 30.1-42.1h (60-72 installed)
Finish variables are back, removable back.

! Notes:
Sliding doors are frosted glass.
Satin anodized aluminum finish on hardware and apron.
Units under 42.1h (72h installed) have an A grade top surface.
Units 42.1h (72h installed) have a 3 grade top surface.
Units have an unfinished back and are designed to go up against a wall.
The shelving area opening remains constant at 14.6 high.
Units are available with either a COM fabric panel or wood panel. These panels are removable and are used to cover cord access.
The back of the units have cord access slots located 2.5 up from the bottom.
The removable back panel has 0.5 clearance at the bottom and 0.75 clearance at the top.

Hutches, Sliding Glass Doors 72/2

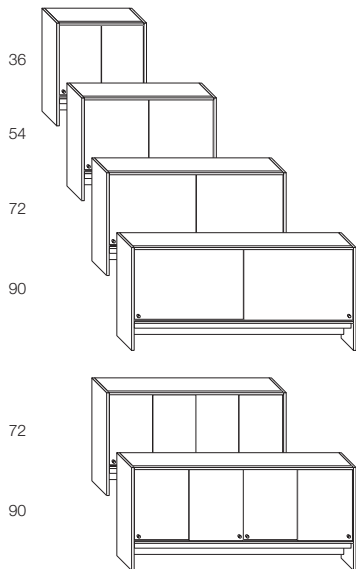

42.1h (72h installed)	w	15d	Shv	COM	Fabric Back Panel	Wood Back Panel
• Hutch72: Sliding2 36 2 Doors	36		2x1	1.8	LLQF-36-15-72 3224	LLQW-36-15-72 2802
• Hutch72: Sliding2 54 2 Doors	54		2x2	2	LLQF-54-15-72 4362	LLQW-54-15-72 3914
• Hutch72: Sliding2 72 2 Doors	72		2x2	2.3	LLQF-72-15-72 5033	LLQW-72-15-72 4562
• Hutch72: Sliding2 72 4 Doors	72		2x2	2.3	LLRF-72-15-72 5246	LLRW-72-15-72 4771
• Hutch72: Sliding2 90 2 Doors	90		2x4	2.8	LLQF-90-15-72 5707	LLQW-90-15-72 5206
• Hutch72: Sliding2 90 4 Doors	90		2x4	2.8	LLRF-90-15-72 5913	LLRW-90-15-72 5413

+ Options/Parameters:
Width range: 30-90
Depth range: 15-18; for depths over 15 add \$1.65 per inch of width (Ex: LLRW-90-18-72 = 5562).
Height range: 30.1-42.1h (60-72 installed)
Finish variables are back, removable back.

! Notes:
Sliding doors are frosted glass.
Units under 42.1h (72h installed) have an A grade top surface.
Units 42.1h (72h installed) have a 3 grade top surface.
Units have an unfinished back and are designed to go up against a wall.
The shelving area opening remains constant at 29.2 high.
Units are available with either a COM fabric panel or wood panel. These panels are removable and are used to cover cord access.
The back of the units have cord access slots located 2.5 up from the bottom.
The removable back panel has 0.5 clearance at the bottom and 0.75 clearance at the top.

Specify: Product Number
Quantity
Tagging
Wood Finish

• Denotes Item is illustrated.
‡ Requires field sub-assembly.

Prices listed in Wood1 Finishes.



Hutches, Sliding Glass Doors 85/2

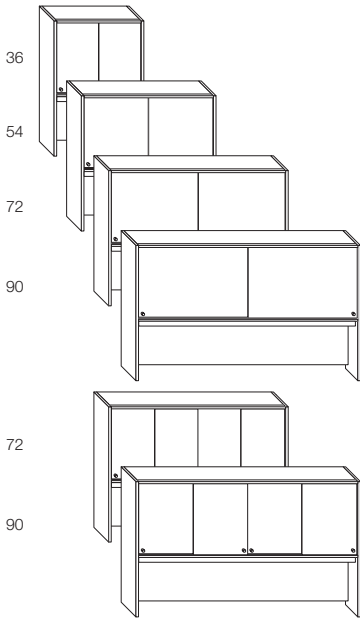

55.1h (85 installed)	w	15d	Shv	COM	Fabric Back Panel	Wood Back Panel	Product Number	List \$	Product Number	List \$
• Hutch85: Sliding2 36 2 Doors	36		2x1	1.8	LLQF-36-15-85	LLQW-36-15-85	3224		3083	
• Hutch85: Sliding2 54 2 Doors	54		2x2	2	LLQF-54-15-85	LLQW-54-15-85	4362		4114	
• Hutch85: Sliding2 72 2 Doors	72		2x2	2.3	LLQF-72-15-85	LLQW-72-15-85	5033		4804	
• Hutch85: Sliding2 72 4 Doors	72		2x2	2.3	LLRF-72-15-85	LLRW-72-15-85	5246		5017	
• Hutch85: Sliding2 90 2 Doors	90		2x4	2.8	LLQF-90-15-85	LLQW-90-15-85	5707		5498	
• Hutch85: Sliding2 90 4 Doors	90		2x4	2.8	LLRF-90-15-85	LLRW-90-15-85	5913		5705	

+ Options/Parametrics:

Width range: 30-90

Depth range: 15-18; for depths over 15 add \$1.65 per inch of width (Ex: LLRW-90-18-85 = 5854).

Height range: 50.1-55.1h (80-85 installed)

Finish variables are back, removable back.

! Notes:

Sliding doors are frosted glass.

Units have a 3 grade top surface.

Units have an unfinished back and are designed to go up against a wall.

The shelving area opening remains constant at 29.2 high.

Units are available with either a COM fabric panel or wood panel. These panels are removable and are used to cover cord access.

The back of the units have cord access slots located 2.5 up from the bottom.

The removable back panel has 0.5 clearance at the bottom and 0.75 clearance at the top.

Specify: Product Number
 Quantity
 Tagging
 Wood Finish

• Denotes Item is illustrated.
 ‡ Requires field sub-assembly.

Prices listed in Wood1 Finishes.



Wall Hutches, Sliding Glass Doors

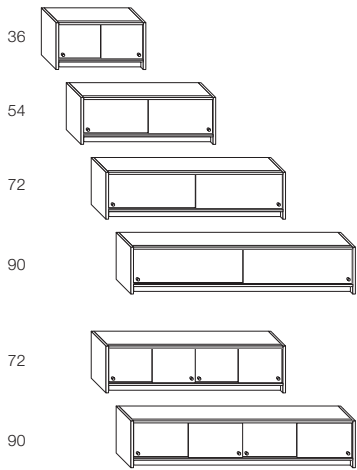

18h (Wall Cleat Included)	w	15d	Shv	Wall Hutch	Product Number	List \$
• WallHutch Sliding1 36 2 Drs	36		1x1	LMN-36-15-18		2327
• WallHutch Sliding1 54 2 Drs	54		1x2	LMN-54-15-18		3112
• WallHutch Sliding1 72 2 Drs	72		1x2	LMN-72-15-18		3540
• WallHutch Sliding1 72 4 Drs	72		1x2	LMP-72-15-18		3752
• WallHutch Sliding1 90 2 Drs	90		1x2	LMN-90-15-18		4029
• WallHutch Sliding1 90 4 Drs	90		1x2	LMP-90-15-18		4236

+ Options/Parametrics:

Width range: 30-90

Depth range: 15-18; for depths over 15 add \$1.10 per inch of width (Ex: LMP-90-18-18 = 4335).

Height is fixed at 18.

! Notes:

Sliding doors are frosted glass.

Satin anodized aluminum finish on hardware and apron.

Units have a 2 grade top surface.

Wall-mount cleats are included for field installation; hutches must be screwed through the back into the wall cleat.

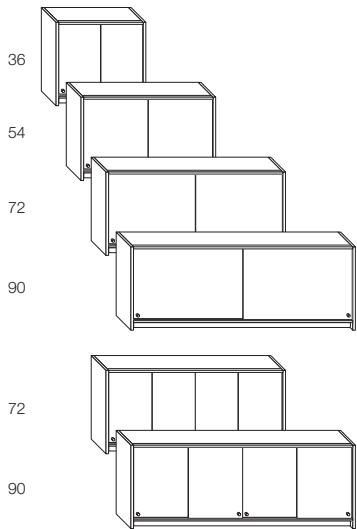

30.6h (Wall Cleat Included)	w	15d	Shv	Wall Hutch	Product Number	List \$
• WallHutch Sliding2 36 2 Drs	36		2x1	LMS-36-15-30.6		2531
• WallHutch Sliding2 54 2 Drs	54		2x2	LMS-54-15-30.6		3818
• WallHutch Sliding2 72 2 Drs	72		2x2	LMS-72-15-30.6		4562
• WallHutch Sliding2 72 4 Drs	72		2x2	LMT-72-15-30.6		4771
• WallHutch Sliding2 90 2 Drs	90		2x4	LMS-90-15-30.6		5298
• WallHutch Sliding2 90 4 Drs	90		2x4	LMT-90-15-30.6		5506

+ Options/Parametrics:

Width range: 30-90

Depth range: 15-18; for depths over 15 add \$1.65 per inch of width (Ex: LMT-90-18-30.6 = 5655).

Height is fixed at 30.6.

! Notes:

Sliding doors are frosted glass.

Satin anodized aluminum finish on hardware and apron.

Units have a 2 grade top surface.

Wall-mount cleats are included for field installation; hutches must be screwed through the back into the wall cleat.

PRIVATE OFFICE: XPECT

Specify: Product Number
Quantity
Tagging
Wood Finish

• Denotes Item is illustrated.
‡ Requires field sub-assembly.

Prices listed in Wood1 Finishes.

Hutch Shelves

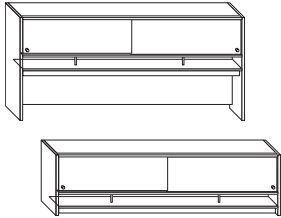

			Product Number	List \$	Product Number	List \$
Attaches to All Hutches ‡	w	15d	6h	Standard Hutch	Wall Hutch	
Hutch Shelf 36	36			LLWS-36-15	308	LLWW-36-15 308
Hutch Shelf 54	54			LLWS-54-15	433	LLWW-54-15 433
Hutch Shelf 72	72			LLWS-72-15	681	LLWW-72-15 681
• Hutch Shelf 90	90			LLWS-90-15	754	LLWW-90-15 754
Hutch Shelf 108	108			LLWS-108-15	885	LLWW-108-15 885

+ Options/Parametrics:

Width range: 18-108

Depth range: 15-18; for depths over 15 add \$0.55 per inch of width (Ex: LLWW-108-18 = 944).

! Notes:

Indicate to which hutch this is to be applied.

Wall Hutches will increase in height by 6 inches.

Fabric Panels, Wall Hung

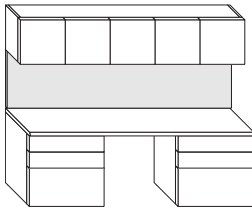

23.4h (Includes Wall Cleats) ‡	w	23.4h	COM	Wall Hutch	Wall Hutch w Shelf	
Fabric Wall Panel: 36	36		1.8	LN-36-23.4	278	LN-36-17.4 278
Fabric Wall Panel: 54	54		2	LN-54-23.4	453	LN-54-17.4 453
Fabric Wall Panel: 72	72		2.3	LN-72-23.4	487	LN-72-17.4 487
• Fabric Wall Panel: 90	90		2.8	LN-90-23.4	545	LN-90-17.4 545
Fabric Wall Panel: 108	108		3.2	LN-108-23.4	591	LN-108-17.4 591

36h (Includes Wall Cleats) ‡	w	36h	COM	Wall Hutch	Wall Hutch w Shelf	
Fabric Wall Panel: 36X	36		1.8	LN-36-36	278	LN-30-30 278
Fabric Wall Panel: 54X	54		2	LN-54-36	453	LN-54-30 453
Fabric Wall Panel: 72X	72		2.3	LN-72-36	487	LN-72-30 487
Fabric Wall Panel: 90X	90		2.8	LN-90-36	545	LN-90-30 545
Fabric Wall Panel: 108X	108		3.2	LN-108-36	591	LN-108-30 591

+ Options/Parametrics:

Width range: 18-108

Height range: 18-36

! Notes:

Cord management behind Fabric Panels is feasible.

For use with Wall Hung Hutches.

Fabric Panels for Wall Hutches with Shelf Added will be 6 inches shorter in height.

Fabric Panels on units over 96w are produced in two sections.



Specify: Product Number
 Quantity
 Tagging
 Wood Finish

• Denotes Item is illustrated.
 ‡ Requires field sub-assembly.

Prices listed in Wood1 Finishes.

Wall Panels	Prod. Prefix	Width Codes and List \$											
		18	24	30	36	45	48	54	60	72	84	90	108
Above Credenza/Desk		18	24	30	36	45	48	54	60	72	84	90	108
WallPanel/Cred 42	LWP42D-	720	733	748	784	804	812	848	885	1074	1264	1277	1318
WallPanel/Cred 56	LWP56D-	770	798	826	877	918	955	983	1033	1250	1468	1496	1579
WallPanel/Cred 72	LWP72D-	-	821	863	905	993	1056	1077	1119	1183	1430	1676	1718
WallPanel/Cred 85	LWP85D-	868	923	979	1078	1161	1189	1244	1321	1593	1865	1921	2086
Full Height		18	24	30	36	45	48	54	60	72	84	90	108
WallPanel/Full 42	LWP42F-	851	894	961	1004	1070	1093	1159	1226	1475	1724	1746	1900
WallPanel/Full 56	LWP56F-	901	958	1039	1097	1185	1213	1294	1374	1652	1929	1964	2161
WallPanel/Full 72	LWP72F-	952	1024	1119	1191	1299	1335	1430	1524	1830	2137	2187	2426
WallPanel/Full 85	LWP85F-	999	1084	1192	1277	1405	1447	1555	1662	1995	2327	2390	2668

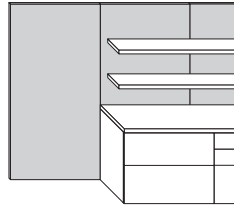

> To Specify Wall Panels:

Determine the Product No. for each set by selecting the appropriate Prod. Prefix and appending the desired Width Code.
Order wall panels in L to R order.
Specify wood finish selection, individually or collectively.

! Notes:

All panels are 1.5 inches thick; exposed ends have finished, matching veneers.
Panels have vertical veneers; horizontal veneers are available on request.
Wood veneers shown here are all Group 1 species and solid paint colors; inquire regarding other species/colors.
Use parametrics (see Options below) to reconcile widths with overall width of companion cases and tops.
Customer walls must be adequately constructed to accept wall hung units.
Wall Panels are designed to mount 0.5-in from the floor; avoid use of baseboards or make flush.

+ Options/Parametrics:

Widths: 12-108. Replace item number width code with actual dimension; use next larger std size for pricing.

Wall Panel Shelves	Prod. Prefix	\$	Prod. Prefix	\$	Prod. Prefix	\$	Prod. Prefix	\$
Wall Panel Shelf 18	LWS18-	733	LWS18L-	728	LWS18R-	728	LWS18X-	724
Wall Panel Shelf 24	LWS24-	742	LWS24L-	737	LWS24R-	737	LWS24X-	733
Wall Panel Shelf 30	LWS30-	751	LWS30L-	746	LWS30R-	746	LWS30X-	742
Wall Panel Shelf 36	LWS36-	759	LWS36L-	755	LWS36R-	755	LWS36X-	751
Wall Panel Shelf 45	LWS45-	831	LWS45L-	826	LWS45R-	826	LWS45X-	822
Wall Panel Shelf 48	LWS48-	835	LWS48L-	831	LWS48R-	831	LWS48X-	826
Wall Panel Shelf 54	LWS54-	844	LWS54L-	839	LWS54R-	839	LWS54X-	835
Wall Panel Shelf 60	LWS60-	898	LWS60L-	893	LWS60R-	893	LWS60X-	889
Wall Panel Shelf 72	LWS72-	916	LWS72L-	911	LWS72R-	911	LWS72X-	906
Wall Panel Shelf 84	LWS84-	1030	LWS84L-	1026	LWS84R-	1026	LWS84X-	1022
Wall Panel Shelf 90	LWS90-	1039	LWS90L-	1035	LWS90R-	1035	LWS90X-	1030
Wall Panel Shelf 108	LWS108-	1065	LWS108L-	1061	LWS108R-	1061	LWS108X-	1057

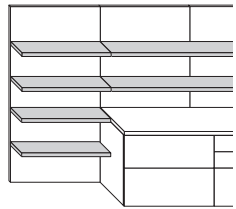

> Specify height location by appending height code to item number:

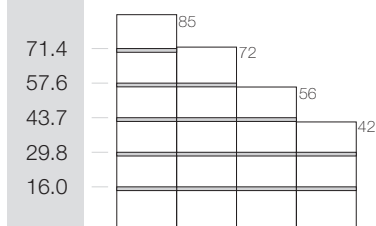

! Notes:

All shelves are 1.5 inches thick; exposed surfaces have finished veneers.
Wood veneers shown here are all Wood1 species and solid paint colors; inquire regarding other species/colors.

+ Options/Parametrics:

Widths: 12-108. Replace item number width code with actual dimension; use next larger std size for pricing.

Specify: Product Number
Quantity
Tagging
Wood Finish

• Denotes Item is illustrated.
‡ Requires field sub-assembly.

Prices listed in Wood1 Finishes.

Towers, Shelving

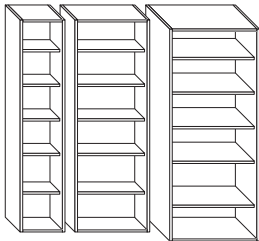
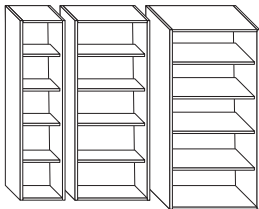
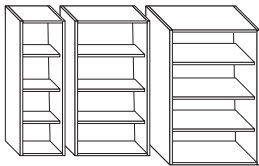
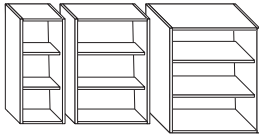
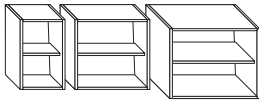

	Product Number	List \$
28 high		
	w d 28h	Unfinished Back
• Tower 28/15: Shelving 18	18 15	LPA-18-15-28 1060
• Tower 28/15: Shelving 30	30 15	LPA-30-15-28 1257
Tower 28/15: Shelving 36	36 15	LPA-36-15-28 1364
Tower 28/24: Shelving 18	18 24	LPA-18-24-28 1171
Tower 28/24: Shelving 30	30 24	LPA-30-24-28 1422
• Tower 28/24: Shelving 36	36 24	LPA-36-24-28 1560
42 high		
	w d 42h	Unfinished Back
• Tower 42/15: Shelving 18	18 15	LPA-18-15-42 1321
• Tower 42/15: Shelving 30	30 15	LPA-30-15-42 1593
Tower 42/15: Shelving 36	36 15	LPA-36-15-42 1735
Tower 42/24: Shelving 18	18 24	LPA-18-24-42 1499
Tower 42/24: Shelving 30	30 24	LPA-30-24-42 1844
• Tower 42/24: Shelving 36	36 24	LPA-36-24-42 2026
56 high		
	w d 56h	Unfinished Back
• Tower 56/15: Shelving 18	18 15	LPA-18-15-56 1566
• Tower 56/15: Shelving 30	30 15	LPA-30-15-56 1909
Tower 56/15: Shelving 36	36 15	LPA-36-15-56 2078
Tower 56/24: Shelving 18	18 24	LPA-18-24-56 1800
Tower 56/24: Shelving 30	30 24	LPA-30-24-56 2238
• Tower 56/24: Shelving 36	36 24	LPA-36-24-56 2460
72 high		
	w d 72h	Unfinished Back
• Tower 72/15: Shelving 18	18 15	LPA-18-15-72 1872
• Tower 72/15: Shelving 30	30 15	LPA-30-15-72 2295
Tower 72/15: Shelving 36	36 15	LPA-36-15-72 2488
Tower 72/24: Shelving 18	18 24	LPA-18-24-72 2198
Tower 72/24: Shelving 30	30 24	LPA-30-24-72 2725
• Tower 72/24: Shelving 36	36 24	LPA-36-24-72 2975
85 high		
	w d 85h	Unfinished Back
• Tower 85/15: Shelving 18	18 15	LPA-18-15-85 2171
• Tower 85/15: Shelving 30	30 15	LPA-30-15-85 2672
Tower 85/15: Shelving 36	36 15	LPA-36-15-85 2900
Tower 85/24: Shelving 18	18 24	LPA-18-24-85 2580
Tower 85/24: Shelving 30	30 24	LPA-30-24-85 3206
• Tower 85/24: Shelving 36	36 24	LPA-36-24-85 3502

+ Options/Parametrics:

Width range: 18-36

Depth range: 15-24

Height range: 28-85

Finish variables are back, shelves.

! Notes:

Number of shelves varies with height of unit: 3 shlvs @ 56h, 4 shlvs @ 72h, and 5 shlvs @ 85h.

Units under 72h have an A grade top surface.

Units 72h and higher have a 3 grade top surface.

Unfinished backs are standard.

Specify: Product Number
Quantity
Tagging
Wood Finish

• Denotes Item is illustrated.
Prices listed in Wood1 Finishes.



Towers, Cabinet Single Door

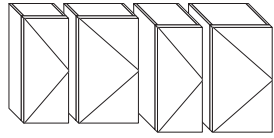

	w	d	42h	Product Number	List \$
42 high				Unfinished Back	
Tower 42/15: Cabinet LH 18	18	15		LPB-18-15-42	1498
• Tower 42/15: Cabinet RH 18	18	15		LPC-18-15-42	1498
Tower 42/15: Cabinet LH 24	24	15		LPB-24-15-42	1672
• Tower 42/15: Cabinet RH 24	24	15		LPC-24-15-42	1672
Tower 42/24: Cabinet LH 18	18	24		LPB-18-24-42	1640
• Tower 42/24: Cabinet RH 18	18	24		LPC-18-24-42	1640
Tower 42/24: Cabinet LH 24	24	24		LPB-24-24-42	1866
• Tower 42/24: Cabinet RH 24	24	24		LPC-24-24-42	1866

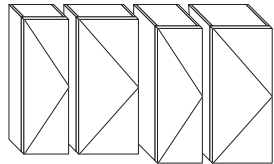

	w	d	56h	Product Number	List \$
56 high				Unfinished Back	
Tower 56/15: Cabinet LH 18	18	15		LPB-18-15-56	1739
• Tower 56/15: Cabinet RH 18	18	15		LPC-18-15-56	1739
Tower 56/15: Cabinet LH 24	24	15		LPB-24-15-56	1968
• Tower 56/15: Cabinet RH 24	24	15		LPC-24-15-56	1968
Tower 56/24: Cabinet LH 18	18	24		LPB-18-24-56	1922
• Tower 56/24: Cabinet RH 18	18	24		LPC-18-24-56	1922
Tower 56/24: Cabinet LH 24	24	24		LPB-24-24-56	2217
• Tower 56/24: Cabinet RH 24	24	24		LPC-24-24-56	2217

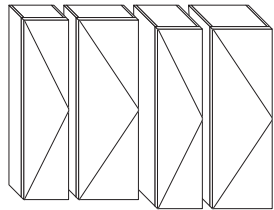

	w	d	72h	Product Number	List \$
72 high				Unfinished Back	
Tower 72/15: Cabinet LH 18	18	15		LPB-18-15-72	2040
• Tower 72/15: Cabinet RH 18	18	15		LPC-18-15-72	2040
Tower 72/15: Cabinet LH 24	24	15		LPB-24-15-72	2340
• Tower 72/15: Cabinet RH 24	24	15		LPC-24-15-72	2340
Tower 72/24: Cabinet LH 18	18	24		LPB-18-24-72	2287
• Tower 72/24: Cabinet RH 18	18	24		LPC-18-24-72	2287
Tower 72/24: Cabinet LH 24	24	24		LPB-24-24-72	2655
• Tower 72/24: Cabinet RH 24	24	24		LPC-24-24-72	2655

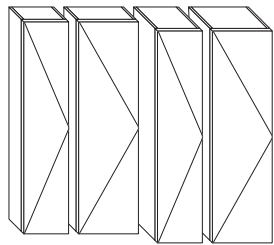

	w	d	85h	Product Number	List \$
85 high				Unfinished Back	
Tower 85/15: Cabinet LH 18	18	15		LPB-18-15-85	2330
• Tower 85/15: Cabinet RH 18	18	15		LPC-18-15-85	2330
Tower 85/15: Cabinet LH 24	24	15		LPB-24-15-85	2692
• Tower 85/15: Cabinet RH 24	24	15		LPC-24-15-85	2692
Tower 85/24: Cabinet LH 18	18	24		LPB-18-24-85	2629
• Tower 85/24: Cabinet RH 18	18	24		LPC-18-24-85	2629
Tower 85/24: Cabinet LH 24	24	24		LPB-24-24-85	3077
• Tower 85/24: Cabinet RH 24	24	24		LPC-24-24-85	3077

+ Options/Parametrics:
 Width range: 18-24
 Depth range: 15-24
 Height range: 42-85
 Finish variables are back, shelves, faces.
 For door locks, specify Option LD; add \$132.

! Notes:
 Number of shelves varies with height of unit: 3 shlvs @ 56h, 4 shlvs @ 72h, and 5 shlvs @ 85h.
 Units under 72 high have an A grade top surface.
 Units 72 high or over have 3 grade top surface.
 Unfinished backs are standard.

Specify: Product Number
 Quantity
 Tagging
 Wood Finish
 Hardware Finish

• Denotes Item is illustrated.
 Prices listed in Wood1 Finishes.



Towers, Cabinet Double Door

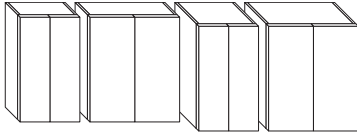

	42 high	w	d	42h	Unfinished Back	Product Number	List \$
•	Tower 42/15: Cabinet DBL 24	24	15			LPD-24-15-42	1812
•	Tower 42/15: Cabinet DBL 36	36	15			LPD-36-15-42	2103
•	Tower 42/24: Cabinet DBL 24	24	24			LPD-24-24-42	2004
•	Tower 42/24: Cabinet DBL 36	36	24			LPD-36-24-42	2363

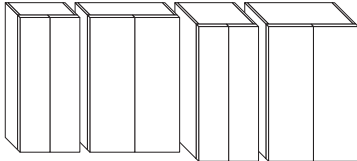

	56 high	w	d	56h	Unfinished Back	Product Number	List \$
•	Tower 56/15: Cabinet DBL 24	24	15			LPD-24-15-56	2105
•	Tower 56/15: Cabinet DBL 36	36	15			LPD-36-15-56	2470
•	Tower 56/24: Cabinet DBL 24	24	24			LPD-24-24-56	2355
•	Tower 56/24: Cabinet DBL 36	36	24			LPD-36-24-56	2795

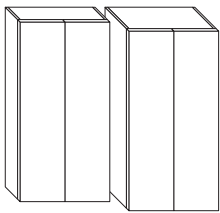

	72 high	w	d	72h	Unfinished Back	Product Number	List \$
•	Tower 72/15: Cabinet DBL 36	36	15			LPD-36-15-72	2919
•	Tower 72/24: Cabinet DBL 36	36	24			LPD-36-24-72	3322

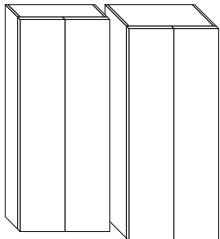

	85 high	w	d	85h	Unfinished Back	Product Number	List \$
•	Tower 85/15: Cabinet DBL 36	36	15			LPD-36-15-85	3357
•	Tower 85/24: Cabinet DBL 36	36	24			LPD-36-24-85	3843

+ Options/Parametrics:

Width range: 24-36

Depth range: 15-24

Height range: 42-85

Finish variables are back, shelves, faces.

For door locks, specify Option LD; add \$132.

! Notes:

Number of shelves varies with height of unit: 3 shlvs @ 56h, 4 shlvs @ 72h, and 5 shlvs @ 85h.

Units under 72 high have an A grade top surface.

Units 72 high or over have 3 grade top surface.

Unfinished backs are standard.



Specify: Product Number
 Quantity
 Tagging
 Wood Finish
 Hardware Finish

Prices listed in Wood1 Finishes.

Towers, Garment

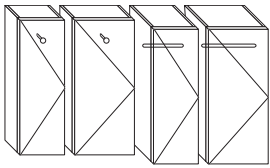

	56 high	w	d	56h	Product Number	List \$
					Unfinished Back	
	Tower 56/15: Garment LH 18	18	15		LPE-18-15-56	1509
•	Tower 56/15: Garment RH 18	18	15		LPF-18-15-56	1509
	Tower 56/15: Garment LH 24	24	15		LPE-24-15-56	1776
•	Tower 56/15: Garment RH 24	24	15		LPF-24-15-56	1776
	Tower 56/24: Garment LH 18	18	24		LPE-18-24-56	1664
•	Tower 56/24: Garment RH 18	18	24		LPF-18-24-56	1664
	Tower 56/24: Garment LH 24	24	24		LPE-24-24-56	1963
•	Tower 56/24: Garment RH 24	24	24		LPF-24-24-56	1963

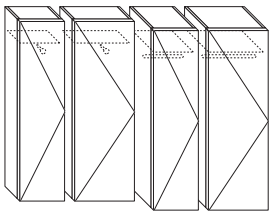

	72 high	w	d	72h	Product Number	List \$
					Unfinished Back	
	Tower 72/15: Garment LH 18	18	15		LPE-18-15-72	1797
•	Tower 72/15: Garment RH 18	18	15		LPF-18-15-72	1797
	Tower 72/15: Garment LH 24	24	15		LPE-24-15-72	2108
•	Tower 72/15: Garment RH 24	24	15		LPF-24-15-72	2108
	Tower 72/24: Garment LH 18	18	24		LPE-18-24-72	2004
•	Tower 72/24: Garment RH 18	18	24		LPF-18-24-72	2004
	Tower 72/24: Garment LH 24	24	24		LPE-24-24-72	2338
•	Tower 72/24: Garment RH 24	24	24		LPF-24-24-72	2338

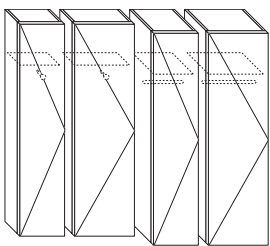

	85 high	w	d	85h	Product Number	List \$
					Unfinished Back	
	Tower 85/15: Garment LH 18	18	15		LPE-18-15-85	2113
•	Tower 85/15: Garment RH 18	18	15		LPF-18-15-85	2113
	Tower 85/15: Garment LH 24	24	15		LPE-24-15-85	2498
•	Tower 85/15: Garment RH 24	24	15		LPF-24-15-85	2498
	Tower 85/24: Garment LH 18	18	24		LPE-18-24-85	2376
•	Tower 85/24: Garment RH 18	18	24		LPF-18-24-85	2376
	Tower 85/24: Garment LH 24	24	24		LPE-24-24-85	2799
•	Tower 85/24: Garment RH 24	24	24		LPF-24-24-85	2799

Towers, Garment-Cabinet

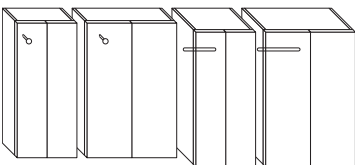

	56h	w	d	56h	Product Number	List \$
					Unfinished Back	
•	Tower 56/15: Garment:Cab 24	24	15		LPH-24-15-56	2344
	Tower 56/15: Cab:Garment 24	24	15		LPG-24-15-56	2344
•	Tower 56/15: Garment:Cab 36	36	15		LPH-36-15-56	2720
	Tower 56/15: Cab:Garment 36	36	15		LPG-36-15-56	2720
•	Tower 56/24: Garment:Cab 24	24	24		LPH-24-24-56	2637
	Tower 56/24: Cab:Garment 24	24	24		LPG-24-24-56	2637
•	Tower 56/24: Garment:Cab 36	36	24		LPH-36-24-56	3095
	Tower 56/24: Cab:Garment 36	36	24		LPG-36-24-56	3095

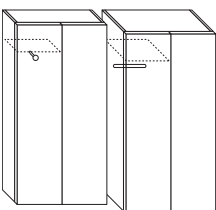

	72h	w	d	72h	Product Number	List \$
					Unfinished Back	
•	Tower 72/15: Garment:Cab 36	36	15		LPH-36-15-72	3312
	Tower 72/15: Cab:Garment 36	36	15		LPG-36-15-72	3312
•	Tower 72/24: Garment:Cab 36	36	24		LPH-36-24-72	3782
	Tower 72/24: Cab:Garment 36	36	24		LPG-36-24-72	3782

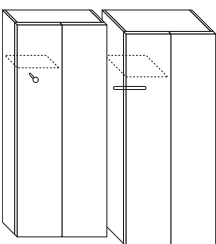

	85h	w	d	85h	Product Number	List \$
					Unfinished Back	
•	Tower 85/15: Garment:Cab 36	36	15		LPH-36-15-85	3881
	Tower 85/15: Cab:Garment 36	36	15		LPG-36-15-85	3881
•	Tower 85/24: Garment:Cab 36	36	24		LPH-36-24-85	4445
	Tower 85/24: Cab:Garment 36	36	24		LPG-36-24-85	4445

+ Options/Parametrics (all listings this page):
 Width range: 18-24 (Garment) and 24-36 (Garment-Cabinet)
 Depth range: 15-24 Height range: 54-85
 Finish variables are back, shelves, faces.
 For door locks, specify Option LD; add \$132.

! Notes:
 Number of shelves varies with height of unit: 3 shlvs @ 56h, 4 shlvs @ 70h, and 5 shlvs @ 85h.
 Units over 80 high get an adjustable shelf above the coat rod.
 Units less than 22 deep get a coat hook instead of a coat rod.
 Units under 72 high have an A grade top surface.
 Units 72 high or over have 3 grade top surface.

Specify: Product Number
 Quantity
 Tagging
 Wood Finish
 Hardware Finish

Prices listed in Wood1 Finishes.

Towers, Cabinet/Drawer

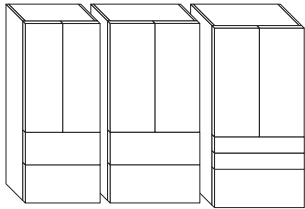
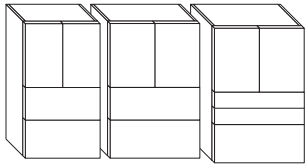

	56h	w	d	56h	Product Number	List \$
					Unfinished Back	
•	Tower 56/18: Cab/LatF 30	30	18		LPJ-30-18-56	2473
	Tower 56/18: Cab/LatB/LatF 30	30	18		LPK-30-18-56	2595
•	Tower 56/18: Cab/LatF 36	36	18		LPJ-36-18-56	3206
	Tower 56/18: Cab/LatB/LatF 36	36	18		LPK-36-18-56	3408
	Tower 56/24: Cab/LatF 30	30	24		LPJ-30-24-56	2644
	Tower 56/24: Cab/LatB/LatF 30	30	24		LPK-30-24-56	2761
	Tower 56/24: Cab/LatF 36	36	24		LPJ-36-24-56	3409
•	Tower 56/24: Cab/LatB/LatF 36	36	24		LPK-36-24-56	3609

	72h	w	d	72h	Product Number	List \$
					Unfinished Back	
•	Tower 72/18: Cab/LatF 30	30	18		LPJ-30-18-72	2923
	Tower 72/18: Cab/LatB/LatF 30	30	18		LPK-30-18-72	3045
•	Tower 72/18: Cab/LatF 36	36	18		LPJ-36-18-72	3693
	Tower 72/18: Cab/LatB/LatF 36	36	18		LPK-36-18-72	3893
	Tower 72/24: Cab/LatF 30	30	24		LPJ-30-24-72	3140
	Tower 72/24: Cab/LatB/LatF 30	30	24		LPK-30-24-72	3262
	Tower 72/24: Cab/LatF 36	36	24		LPJ-36-24-72	3948
•	Tower 72/24: Cab/LatB/LatF 36	36	24		LPK-36-24-72	4148

+ Options/Parametrics:

Width range: 30, 36 only

Depth range: 18-24

Height range: 56-72

Finish variables are back, shelves, faces.

For Cabinet/Door Locks, specify Option LD; add \$132.

For Drawer Gang Locks, specify Option LG; add \$183.

! Notes:

Units under 72 high have an A grade top surface.

Units 72 high or over have 3 grade top surface.

Unfinished backs are standard.



Specify: Product Number
 Quantity
 Tagging
 Wood Finish
 Hardware Finish

Prices listed in Wood1 Finishes.

Towers, Drawer

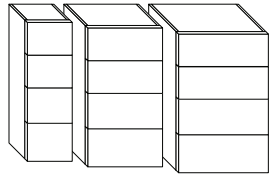
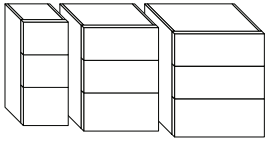

				Product Number	List \$
42h (3-Drawer)					
	w	d	42h	Unfinished Back	
• Tower18: 3F 18	18	18		LPL-18-18-42	1918
Tower18: 3LatF 30	30	18		LPL-30-18-42	2236
Tower18: 3LatF 36	36	18		LPL-36-18-42	2380
Tower24: 3F 18	18	24		LPL-18-24-42	1958
• Tower24: 3LatF 30	30	24		LPL-30-24-42	2318
Tower24: 3LatF 36	36	24		LPL-36-24-42	2468
Tower30: 3F 18	18	30		LPL-18-30-42	2042
Tower30: 3LatF 30	30	30		LPL-30-30-42	2417
• Tower30: 3LatF 36	36	30		LPL-36-30-42	2574
Tower36: 3F 18	18	36		LPL-18-36-42	2391
56h (4-Drawer)					
	w	d	56h	Unfinished Back	
• Tower18: 4F 18	18	18		LPM-18-18-56	2451
Tower18: 4LatF 30	30	18		LPM-30-18-56	2876
Tower18: 4LatF 36	36	18		LPM-36-18-56	3071
Tower24: 4F 18	18	24		LPM-18-24-56	2504
• Tower24: 4LatF 30	30	24		LPM-30-24-56	2982
Tower24: 4LatF 36	36	24		LPM-36-24-56	3185
Tower30: 4F 18	18	30		LPM-18-30-56	2619
Tower30: 4LatF 30	30	30		LPM-30-30-56	3119
• Tower30: 4LatF 36	36	30		LPM-36-30-56	3328
Tower36: 4F 18	18	36		LPM-18-36-56	3081

+ Options/Parametrics:

Widths 18, 30 and 36 only.

Depth range: 18-36 (18w units); 18-30 (30, 36w units).

Finish variable is face.

To include Anti-Tilt Mechanisms, specify Option AT; add \$474.

! Notes:

Drawer Towers must be secured on location to the wall; otherwise, specify Option AT above.

For Drawer Gang Locks, specify Option LG; add \$183.

Units listed above have finished tops.

Drawers are 0.5 Birch with dovetailed corners.

Drawer bottoms are 0.25 inch thick dadoed into drawer sides.

Slides are ball bearing full extension.

File drawers include Pendaflex file hanging system.

Units under 22 deep have a 15 deep drawer with front-to-back filing only.

Units over 22 deep and under 33 deep have a 20 deep drawer.

Units 33 deep and more have a 30 deep drawer.

Specify: Product Number
Quantity
Tagging
Wood Finish
Hardware Finish

Prices listed in Wood1 Finishes.