

PRICING & SPECIFICATION GUIDE
Danza Collection

June 1, 2022

TUOHY



Casegoods: **Danza**

Vertical Cadence	AD2
Drawer Layouts	AD3
Desk Shells	AD4
Desk Returns	AD6
Runoffs	AD8
Computer Corners	AD16
Wall Hung Credenza, AdjHt	AD18
Pedestals	AD19
Mobile Pedestals	AD21
Modesty Panels	AD22
Base Panels	AD23
Top Supports	AD23
Tops	AD24
Top Dividers	AD28
Hutches	AD29
Task Lights for Hutches	AD31
Wall Panels	AD32
Shelves	AD35
Towers Lateral Files	AD36
Towers 60.5	AD37
Towers 72.5h	AD40
Towers 84.5h	AD43

Vertical Cadence

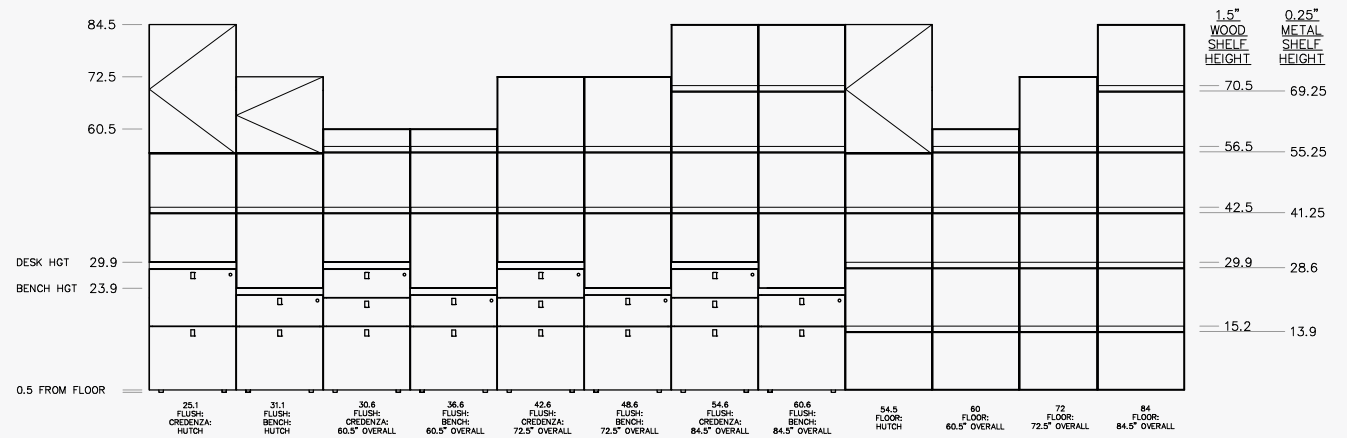

Drawer Layouts: Plan View

Slides: Under-Mount

Mobile 20d
Drawers 18d

16w 18w 24w

Pedestal Units 20d
Drawers 18d

16w 18w 20w 24w 30w 36w

Pedestal Units 24d
Drawers 21d

16w 18w 20w 24w 30w 36w

Peds 30d & 36d
Dwr 27d Dwr 15d

18w w-varies
Ht.Adj.

Box Drawer w Divider



Lateral Filing

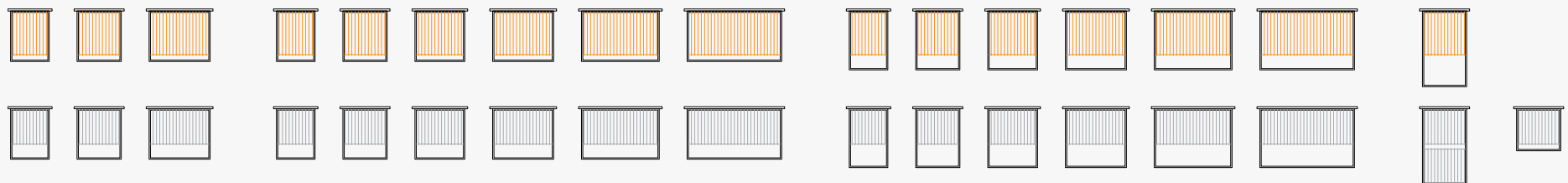

Front-to-Back Filing

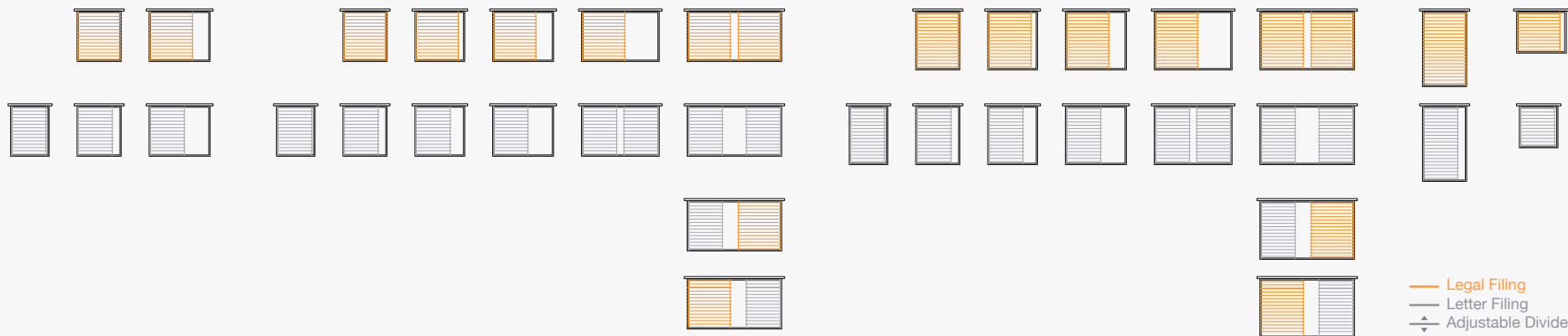

— Legal Filing
— Letter Filing
⇕ Adjustable Divider

DRAWER CONSTRUCTION

A fine point for a quality casegood product is the inner drawer construction. Each TUOHY casegood offers you uncompromised excellence in this area as well. Drawer boxes are constructed with dovetail joinery for maximum durability. The drawer face is mounted separately to this box (i.e., five-sided construction) to maintain integrity.

Drawer bottoms are dadoed on all four sides. Slides for box drawers are rated at 100 pounds static load capacity; slides for file drawers are rated at a heavy duty 150 static load capacity. All slides are concealed, full extension and soft-close.

Box drawers have a removable divider, adjustable when depicted (⇕). File drawers have file frames for filing laterally or front-to-back, as depicted above. For Drawers for Lap Area, Drawer Pencil Tray, and Locks: See the Introduction/Terms-Options section of the Master Price List, page 12.

Desk Shell 29.9h

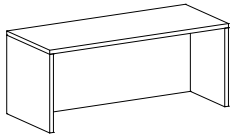
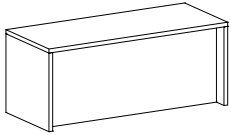

Description	Product No.	Spec Code	List \$	Spec Code	List \$	Spec Code	List \$	Spec Code	List \$
		HPL Top		Wood1 Top		Solid Surface Top		OcuWrite Top	
Desk 60w 30d	DZA?6030	HP	2600	W1	2866	SS	3711	AG	4138
Desk 60w 36d	DZA?6036	HP	2814	W1	3075	SS	4091	AG	4644
Desk 66w 30d	DZA?6630	HP	2698	W1	2965	SS	3894	AG	4385
Desk 66w 36d	DZA?6636	HP	2922	W1	3183	SS	4299	AG	4931
• Desk 72w 30d	DZA?7230	HP	2799	W1	3063	SS	4075	AG	4631
Desk 72w 36d	DZA?7236	HP	3031	W1	3289	SS	4504	AG	5214
Desk 78w 30d	DZA?7830	HP	2898	W1	3158	SS	4256	AG	4877
Desk 78w 36d	DZA?7836	HP	3140	W1	3396	SS	4713	AG	5500
Desk 84w 30d	DZA?8430	HP	2997	W1	3256	SS	4440	AG	5123
Desk 84w 36d	DZA?8436	HP	3249	W1	3502	SS	4920	AG	5785

! Notes:

Top finishes are listed above; specify Wood1 finish for elements below worksurface.
 All desk pedestals are 18w wide.
 Pedestals are 24d on 30d shell.
 Pedestals are 30d on 36d shell.
 Glass tops have metal edges; MRBAS, Metal Resin Brushed Aluminum w/ Steel Tint; HPL tops have PVC edges; all other tops are self-edged.
 Standard HPL top material is Formica 949 White Matte.
 Standard Solid Surface material is Avonite Polaris White, Matte.
 OcuWrite Back-Painted Glass color: O.BWT White.
 Acrylic faces are Stylelite Arctic White standard.
 Modesty panel is set back 5.25 inches.
 Locks included.

+ Options:

For 30d Desk Shell:
 For shell only, omit the ? in the 4th digit.
 To add B/B/F left, append 4th digit from ? to A; and add \$1921 to total
 To add B/B/F right, append 4th digit from ? to B; and add \$1921 to total
 To add F/F left, append 4th digit from ? to C; and add \$1769 to total
 To add F/F right, append 4th digit from ? to D; and add \$1769 to total
 To add B/B/F left - F/F right, append 4th digit from ? to E; and add \$3692 to total.
 To add F/F left - B/B/F right, append 4th digit from ? to F; and add \$3692 to total
 To add B/B/F left - B/B/F right, append 4th digit from ? to G; and add \$3841 to total
 To add F/F left - F/F right append 4th digit from ? to H; and add \$3539 to total
 For 36d Desk Shell:
 To add B/B/F left, append 4th digit from ? to A; and add \$2171 to total
 To add B/B/F right, append 4th digit from ? to B; and add \$2171 to total
 To add F/F left, append 4th digit from ? to C; and add \$1966 to total
 To add F/F right, append 4th digit from ? to D; and add \$1966 to total
 To add B/B/F left - F/F right, append 4th digit from ? to E; and add \$4138 to total
 To add F/F left - B/B/F right, append 4th digit from ? to F; and add \$4138 to total
 To add B/B/F left - B/B/F right, append 4th digit from ? to G; and add \$4341 to total
 To add F/F left F/F right, append 4th digit from ? to H; and add \$3935 to total
 To add metal edge to Wood, Laminate or Acrylic Solid Surface tops, add ME to the end of Spec code, and price that correlates to top size from metal edge table.
 Metal edge table is located just below Top options.
 To add acrylic faces, append A to end of Product Code, and add \$437 List per pedestal.
 Pull finish is standard MRBAS, Brushed Aluminum w/Steel tint; for polished specify MPA, Polished Aluminum.

Desk Shell 29.9-48.4h
Adjustable Height

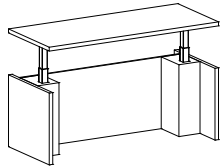
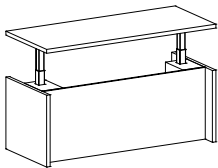

Description	Product No.	Spec Code	List \$	Spec Code	List \$	Spec Code	List \$	Spec Code	List \$
		HPL Top		Wood1 Top		Solid Surface Top		OcuWrite Top	
Desk 60w 30d	DZB?6030	HP	5281	W1	5549	SS	6395	AG	6819
Desk 60w 36d	DZB?6036	HP	5495	W1	5759	SS	6773	AG	7326
Desk 66w 30d	DZB?6630	HP	5382	W1	5647	SS	6576	AG	7065
Desk 66w 36d	DZB?6636	HP	5606	W1	5866	SS	6979	AG	7612
• Desk 72w 30d	DZB?7230	HP	5481	W1	5744	SS	6757	AG	7313
Desk 72w 36d	DZB?7236	HP	5714	W1	5973	SS	7188	AG	7898
Desk 78w 30d	DZB?7830	HP	5580	W1	5842	SS	6940	AG	7559
Desk 78w 36d	DZB?7836	HP	5823	W1	6078	SS	7394	AG	8181
Desk 84w 30d	DZB?8430	HP	5680	W1	5938	SS	7121	AG	7804
Desk 84w 36d	DZB?8436	HP	5932	W1	6185	SS	7602	AG	8467

! Notes:

Top finishes are listed above; specify Wood1 finish for elements below worksurface.
 All desk pedestals are 18w wide.
 Pedestals are 24d on 30d shell.
 Pedestals are 30d on 36d shell.
 Glass tops have metal edges; MRBAS, Metal Resin Brushed Aluminum w/ Steel Tint; HPL tops have PVC edges; all other tops are self-edged.
 Standard HPL top material is Formica 949 White Matte.
 Standard Solid Surface material is Avonite Polaris White, Matte.
 OcuWrite Back-Painted Glass color: O.BWT White.
 Acrylic faces are Stylelite Arctic White standard.
 Modesty panel is set back 5.25 inches.
 Locks Included.

+ Options:

For shell only, omit the ? in the 4th digit.
 For 30d Desk Shell:
 To add B/B/F left, append 4th digit from ? to A; and add \$1769 to total
 To add B/B/F right, append 4th digit from ? to B; and add \$1769 to total
 To add B/B/F left - B/B/F right, append 4th digit from ? to G; and add \$3691 to total
 For 36d Desk Shell:
 To add B/B/F left, append 4th digit from ? to A; and add \$1966 to total
 To add B/B/F right, append 4th digit from ? to B; and add \$1966 to total
 To add B/B/F left - B/B/F right, append 4th digit from ? to G; and add \$4138 to total
 To add metal edge to Wood, Laminate or Acrylic Solid Surface tops, add ME to the end of Spec code, and price that correlates to top size from metal edge table.
 Metal edge table is located just below Top options.
 To add acrylic faces, append A to end of Product Code, and add \$437 List per pedestal.
 Pull finish is standard MRBAS, Brushed Aluminum w/Steel tint; for polished specify MPA, Polished Aluminum.
 Specify White, Silver or Black for height adjustable leg color.

Desk Return Shell 29.9h

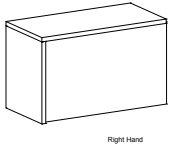

Right Hand

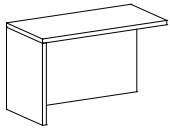

Description	Product No.	Spec Code	List \$	Spec Code	List \$	Spec Code	List \$	Spec Code	List \$
1.5 End Panel/Mod Panel		HPL Top		Wood1 Top		Solid Surface Top		OcuWrite Top	
• Return 48w 24d	DZC?4824	HP	1836	W1	2049	SS	2589	AG	2889
Return 54w 24d	DZC?5424	HP	1933	W1	2143	SS	2751	AG	3103
Return 60w 24d	DZC?6024	HP	2032	W1	2239	SS	2914	AG	3317

! Notes:

Top finishes are listed above; specify Wood1 finish for elements below worksurface.

All return pedestals are 18w x 20d.

Glass tops have metal edges; MRBAS, Metal Resin Brushed Aluminum w/ Steel Tint; HPL tops have PVC edges; all other tops are self-edged.

Standard HPL top material is Formica 949 White Matte.

Standard Solid Surface material is Avonite Polaris White, Matte.

OcuWrite Back-Painted Glass color: O.BWT White.

Acrylic faces are Stylelite Arctic White standard.

Modesty panel is recessed 1.5-in.

Specify L, for left; or R, for right hand runoff. Place at the end of Product number.

Locks Included.

+ Options:

For 24d Shell:

For shell only, omit the ? in the 4th digit.

To add B/B/F left, append 4th digit from ? to E; and add \$1921 to total

To add B/B/F right, append 4th digit from ? to F; and add \$1921 to total

To add F/F left, append 4th digit from ? to G; and add \$1769 to total

To add F/F right, append 4th digit from ? to H; and add \$1769 to total

To add metal edge to Wood, Laminate or Acrylic Solid Surface tops, add ME to the end of Spec code, and price that correlates to top size from metal edge table.

Metal edge table is located just below Top options.

To add acrylic faces, append A to end of Product Code, and add \$437List

Pull finish is standard MRBAS, Brushed Aluminum w/Steel tint; for polished specify MPA, Polished Aluminum.

Desk Return Shell 29.9-48.4h
Height Adjustable

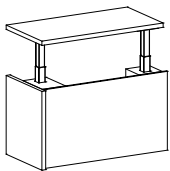

Right Hand

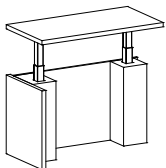

Left Hand

Description	Product No.	Spec Code	List \$	Spec Code	List \$	Spec Code	List \$	Spec Code	List \$
1.5 End Panel/Mod Panel		HPL Top		Wood1 Top		Solid Surface Top		OcuWrite Top	
• Runoff 48w 24d	DZD?4824	HP	4492	W1	4701	SS	5242	AG	5543
Runoff 54w 24d	DZD?5424	HP	4587	W1	4797	SS	5405	AG	5757
Runoff 60w 24d	DZD?6024	HP	4685	W1	4892	SS	5567	AG	5972

! Notes:

Top finishes are listed above; specify Wood1 finish for elements below worksurface.
 Height adjustable legs will be inside plinths.
 Glass tops have metal edges; MRBAS, Metal Resin Brushed Aluminum w/ Steel Tint; HPL tops have PVC edges; all other tops are self-edged.
 Standard HPL top material is Formica 949 White Matte.
 Standard Solid Surface material is Avonite Polaris White, Matte.
 OcuWrite Back-Painted Glass color: O.BWT White.
 Specify L for left, or R for right hand runoff. Place at the end of Product number.
 Mod Panel set back 1.5 inches.
 Locks included.

+ Options:

To add metal edge to Wood, Laminate or Acrylic Solid Surface tops, add ME to the end of Spec code, and price that correlates to top size from metal edge table.
 Metal edge table is located just below Top options.
 Pull finish is standard MRBAS, Brushed Aluminum w/Steel tint; for polished specify MPA, Polished Aluminum.
 Specify White, Silver or Black for height adjustable leg color.

Runoff with Leg, 29.9h
Straight Leg



Runoff with Leg, 29.9h
Loop Leg

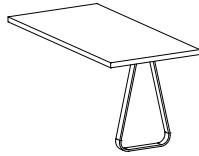

Description	Product No.	Spec Code	List \$	Spec Code	List \$	Spec Code	List \$	Spec Code	List \$
		HPL Top		Wood1 Top		Solid Surface Top		OcuWrite Top	
Runoff 48w 30d	DZES4830	HP	1967	W1	2343	SS	3316	AG	3720
Runoff 48w 36d	DZES4836	HP	2045	W1	2419	SS	3523	AG	4031
Runoff 54w 30d	DZES5430	HP	2015	W1	2391	SS	3446	AG	3916
Runoff 54w 36d	DZES5436	HP	2104	W1	2473	SS	3680	AG	4265
• Runoff 60w 30d	DZES6030	HP	2064	W1	2437	SS	3575	AG	4109
Runoff 60w 36d	DZES6036	HP	2161	W1	2528	SS	3836	AG	4498
Runoff 66w 30d	DZES6630	HP	2112	W1	2482	SS	3706	AG	4303
Runoff 66w 36d	DZES6636	HP	2218	W1	2583	SS	3992	AG	4730
Runoff 72w 30d	DZES7230	HP	2161	W1	2528	SS	3836	AG	4498
Runoff 72w 36d	DZES7236	HP	2276	W1	2638	SS	4149	AG	4965
		HPL Top		Wood1 Top		Solid Surface Top		OcuWrite Top	
Runoff 48w 30d	DZEC4830	HP	2101	W1	2477	SS	3449	AG	3851
Runoff 48w 36d	DZEC4836	HP	2177	W1	2550	SS	3657	AG	4164
Runoff 54w 30d	DZEC5430	HP	2147	W1	2523	SS	3577	AG	4046
Runoff 54w 36d	DZEC5436	HP	2234	W1	2605	SS	3813	AG	4396
• Runoff 60w 30d	DZEC6030	HP	2196	W1	2569	SS	3709	AG	4241
Runoff 60w 36d	DZEC6036	HP	2293	W1	2661	SS	3970	AG	4631
Runoff 66w 30d	DZEC6630	HP	2245	W1	2614	SS	3839	AG	4435
Runoff 66w 36d	DZEC6636	HP	2351	W1	2715	SS	4125	AG	4863
Runoff 72w 30d	DZEC7230	HP	2293	W1	2661	SS	3970	AG	4631
Runoff 72w 36d	DZEC7236	HP	2408	W1	2770	SS	4282	AG	5096

! Notes:

Top finishes are listed above.

Glass tops have metal edges; MRBAS, Metal Resin Brushed Aluminum w/ Steel Tint; HPL tops have PVC edges; all other tops are self-edged.

Standard HPL top material is Formica 949 White Matte.

Standard Solid Surface material is Avonite Polaris White, Matte.

OcuWrite Back-Painted Glass color: O.BWT White.

+ Options:

Standard leg colors are MRTG: Thunder Grey, MRW: White, MRB: Black, MRSA: Satin Aluminum.

Optional: MPA: Polished Aluminum, MRBAS: Brushed Aluminum w/Steel Tint.

Straight Leg; Polished Aluminum add = \$1009 list, Brushed Aluminum w/Steel Tint add= \$255 list.

Continuous Loop; Polished Aluminum add = \$1189 list, Brushed Aluminum w/Steel Tint add = \$300 list.

To add metal edge to Wood, Laminate or Acrylic Solid Surface tops, add ME to the end of Spec code, and price that correlates to top size from metal edge table.

Metal edge table is located just below Top options.

Runoff, Short EndPnl & Mod 29.9h

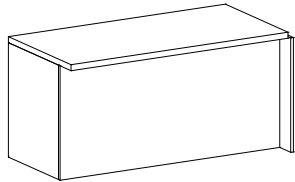

Right Hand

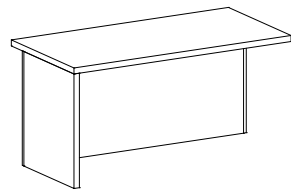

Left Hand

Description	Product No.	Spec Code	List \$	Spec Code	List \$	Spec Code	List \$	Spec Code	List \$
		HPL Top		Wood1 Top		Solid Surface Top		OcuWrite Top	
Runoff 48w 30d	DZEA4830	HP	1936	W1	2143	SS	2819	AG	3221
Runoff 48w 36d	DZEA4836	HP	2060	W1	2263	SS	3073	AG	3579
Runoff 54w 30d	DZEA5430	HP	1983	W1	2189	SS	2948	AG	3416
Runoff 54w 36d	DZEA5436	HP	2118	W1	2318	SS	3230	AG	3813
• Runoff 60w 30d	DZEA6030	HP	2033	W1	2234	SS	3079	AG	3612
Runoff 60w 36d	DZEA6036	HP	2175	W1	2372	SS	3385	AG	4046
Runoff 66w 30d	DZEA6630	HP	2081	W1	2280	SS	3209	AG	3805
Runoff 66w 36d	DZEA6636	HP	2233	W1	2427	SS	3542	AG	4280
Runoff 72w 30d	DZEA7230	HP	2129	W1	2327	SS	3340	AG	4001
Runoff 72w 36d	DZEA7236	HP	2290	W1	2482	SS	3699	AG	4514

! Notes:

Top finishes are listed above.

1.5-in End Panel.

Glass tops have metal edges; MRBAS, Metal Resin Brushed Aluminum w/ Steel Tint; HPL tops have PVC edges; all other tops are self-edged.

Standard HPL top material is Formica 949 White Matte.

Standard Solid Surface material is Avonite Polaris White, Matte.

OcuWrite Back-Painted Glass color: O.BWT White.

Modesty panel is set back 5.25 inches.

+ Options:

Specify Wood1 finish for End Panel and Modesty.

Specify L, for left; or R, for right hand runoff. Place at the end of Product number.

To add metal edge to Wood, Laminate or Acrylic Solid Surface tops, add ME to the end of Spec code, and price that correlates to top size from metal edge table.

Metal edge table is located just below Top options.

Runoff, EndPnl & Modesty 29.9h

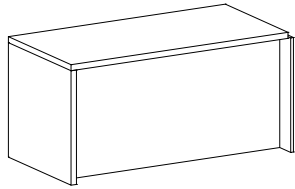

Right Hand

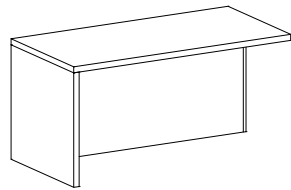

Left Hand

Description	Product No.	Spec Code	List \$	Spec Code	List \$	Spec Code	List \$	Spec Code	List \$
		HPL Top		Wood1 Top		Solid Surface Top		OcuWrite Top	
Runoff 48w 30d	DZEB4830	HP	1983	W1	2190	SS	2865	AG	3269
Runoff 48w 36d	DZEB4836	HP	2107	W1	2310	SS	3121	AG	3626
Runoff 54w 30d	DZEB5430	HP	2032	W1	2235	SS	2995	AG	3463
Runoff 54w 36d	DZEB5436	HP	2164	W1	2365	SS	3277	AG	3862
• Runoff 60w 30d	DZEB6030	HP	2079	W1	2281	SS	3125	AG	3658
Runoff 60w 36d	DZEB6036	HP	2223	W1	2420	SS	3433	AG	4094
Runoff 66w 30d	DZEB6630	HP	2128	W1	2327	SS	3256	AG	3852
Runoff 66w 36d	DZEB6636	HP	2280	W1	2475	SS	3590	AG	4328
Runoff 72w 30d	DZEB7230	HP	2175	W1	2372	SS	3385	AG	4046
Runoff 72w 36d	DZEB7236	HP	2337	W1	2529	SS	3745	AG	4561

! Notes:

Top finishes are listed above.

1.5-in End Panel.

Glass tops have metal edges; MRBAS, Metal Resin Brushed Aluminum w/ Steel Tint; HPL tops have PVC edges; all other tops are self-edged.

Standard HPL top material is Formica 949 White Matte.

Standard Solid Surface material is Avonite Polaris White, Matte.

OcuWrite Back-Painted Glass color: O.BWT White.

Modesty panel is set back 5.25 inches.

+ Options:

Specify Wood1 finish for End Panel and Modesty.

Specify L, for left; or R, for right hand runoff. Place at the end of Product number.

To add metal edge to Wood, Laminate or Acrylic Solid Surface tops, add ME to the end of Spec code, and price that correlates to top size from metal edge table.

Metal edge table is located just below Top options.

Runoff, Ped & Modesty 29.9h

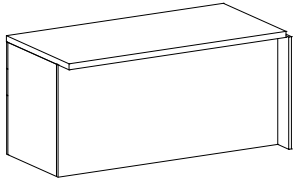

Right Hand

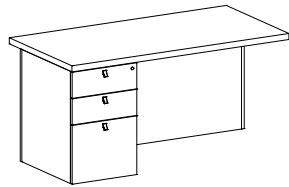

Left Hand

Description	Product No.	Spec Code	List \$	Spec Code	List \$	Spec Code	List \$	Spec Code	List \$
		HPL Top		Wood1 Top		Solid Surface Top		OcuWrite Top	
Runoff 48w 30d	DZF?4830	HP	1701	W1	1909	SS	2583	AG	2986
Runoff 48w 36d	DZF?4836	HP	1778	W1	1981	SS	2792	AG	3298
Runoff 54w 30d	DZF?5430	HP	1749	W1	1953	SS	2714	AG	3182
Runoff 54w 36d	DZF?5436	HP	1835	W1	2036	SS	2948	AG	3532
Runoff 60w 30d	DZF?6030	HP	1796	W1	2000	SS	2844	AG	3376
Runoff 60w 36d	DZF?6036	HP	1893	W1	2090	SS	3104	AG	3765
Runoff 66w 30d	DZF?6630	HP	1845	W1	2045	SS	2974	AG	3570
Runoff 66w 36d	DZF?6636	HP	1952	W1	2145	SS	3261	AG	3998
Runoff 72w 30d	DZF?7230	HP	1893	W1	2090	SS	3104	AG	3765
Runoff 72w 36d	DZF?7236	HP	2009	W1	2200	SS	3416	AG	4232

! Notes:

Top finishes are listed above; specify Wood1 finish for elements below worksurface.

All runoff pedestals are 18w.

Pedestals are 24d on 30d shell.

Pedestals are 30d on 36d shell.

Glass tops have metal edges; MRBAS, Metal Resin Brushed Aluminum w/ Steel Tint; HPL tops have PVC edges; all other tops are self-edged.

Standard HPL top material is Formica 949 White Matte.

Standard Solid Surface material is Avonite Polaris White, Matte.

OcuWrite Back-Painted Glass color: O.BWT White.

Acrylic faces are Stylelite Arctic White standard.

Modesty panel is set back 5.25 inches.

Locks included.

+ Options:

For 30d Runoff Shell:

To add B/B/F left, append 4th digit to E and add \$1921 to total.

To add B/B/F right, append 4th digit to F and add \$1921 to total.

To add F/F left, append 4th digit to G and add \$1769 to total.

To add F/F right, append 4th digit to H and add \$1769 to total.

For 36d Runoff Shell:

To add B/B/F left, append 4th digit to E and add \$2171 to total.

To add B/B/F right, append 4th digit to F and add \$2171 to total.

To add F/F left, append 4th digit to G and add \$1966 to total.

To add F/F right, append 4th digit to H and add \$1966 to total.

To add acrylic faces, append A to end of Product Code, and add \$437 List

To add metal edge to Wood, Laminate or Acrylic Solid Surface tops, add ME to the end of Spec code, and price that correlates to top size from metal edge table.

Metal edge table is located just below Top options.

Pull finish is standard MRBAS, Brushed Aluminum w/Steel tint; for polished specify MPA, Polished Aluminum.

Runoff Shell, Short End Pnl 29.9-48.4h
Height Adjustable

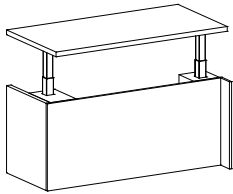

Right Hand

Description	Product No.	Spec Code	List \$	Spec Code	List \$	Spec Code	List \$	Spec Code	List \$
		HPL Top		Wood1 Top		Solid Surface Top		OcuWrite Top	
Runoff 48w 30d	DZEE4830	HP	4655	W1	4862	SS	5538	AG	5940
Runoff 48w 36d	DZEE4836	HP	4779	W1	4983	SS	5792	AG	6298
Runoff 54w 30d	DZEE5430	HP	4702	W1	4908	SS	5667	AG	6136
Runoff 54w 36d	DZEE5436	HP	4837	W1	5038	SS	5949	AG	6532
Runoff 60w 30d	DZEE6030	HP	4752	W1	4953	SS	5798	AG	6330
Runoff 60w 36d	DZEE6036	HP	4894	W1	5093	SS	6104	AG	6765
Runoff 66w 30d	DZEE6630	HP	4800	W1	4999	SS	5928	AG	6524
Runoff 66w 36d	DZEE6636	HP	4952	W1	5147	SS	6261	AG	6999
Runoff 72w 30d	DZEE7230	HP	4848	W1	5046	SS	6059	AG	6720
Runoff 72w 36d	DZEE7236	HP	5010	W1	5203	SS	6418	AG	7234

Runoff Shell, End Pnl 29.9-48.4h
Height Adjustable

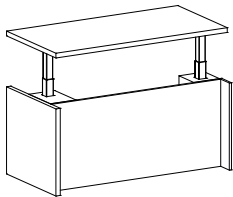

Right Hand

		HPL Top		Wood1 Top		Solid Surface Top		OcuWrite Top	
Runoff 48w 30d	DZEF4830	HP	4702	W1	4909	SS	5584	AG	5988
Runoff 48w 36d	DZEF4836	HP	4826	W1	5029	SS	5840	AG	6345
Runoff 54w 30d	DZEF5430	HP	4751	W1	4955	SS	5714	AG	6182
Runoff 54w 36d	DZEF5436	HP	4883	W1	5084	SS	5996	AG	6581
• Runoff 60w 30d	DZEF6030	HP	4798	W1	5000	SS	5844	AG	6377
Runoff 60w 36d	DZEF6036	HP	4942	W1	5139	SS	6152	AG	6813
Runoff 66w 30d	DZEF6630	HP	4847	W1	5046	SS	5975	AG	6571
Runoff 66w 36d	DZEF6636	HP	4999	W1	5194	SS	6309	AG	7047
Runoff 72w 30d	DZEF7230	HP	4894	W1	5093	SS	6104	AG	6765
Runoff 72w 36d	DZEF7236	HP	5056	W1	5248	SS	6465	AG	7280

! Notes:

Top finishes are listed above; specify Wood1 finish for elements below worksurface.
 Glass tops have metal edges; MRBAS, Metal Resin Brushed Aluminum w/ Steel Tint; HPL tops have PVC edges; all other tops are self-edged.
 Standard HPL top material is Formica 949 White Matte.
 Standard Solid Surface material is Avonite Polaris White, Matte.
 Mitre folded plinth construction.

1.5-in End Panel.
 OcuWrite Back-Painted Glass color: O.BWT White.

+ Options:

Specify Wood1 finish for End Panel and Modesty.
 Specify L for left, or R for right hand runoff. Place at the end of product number.
 Specify White, Silver or Black for height adjustable leg color.

To add metal edge to Wood, Laminate or Acrylic Solid Surface tops, add ME to the end of Spec code, and price that correlates to top size from metal edge table.
 Metal edge table is located just below Top options.

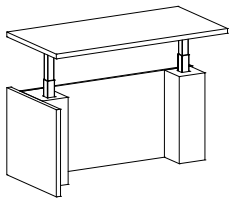

Left Hand

Runoff, Plinth-Mod-Plinth 29.9-48.4h
Height Adjustable

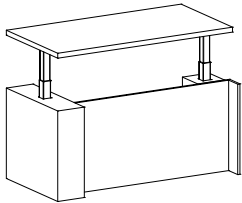

Description	Product No.	Spec Code	List \$	Spec Code	List \$	Spec Code	List \$	Spec Code	List \$
		HPL Top		Wood1 Top		Solid Surface Top		OcuWrite Top	
Runoff 48w 30d	DZEG4830	HP	4971	W1	5179	SS	5854	AG	6258
Runoff 48w 36d	DZEG4836	HP	5140	W1	5344	SS	6154	AG	6661
Runoff 54w 30d	DZEG5430	HP	5020	W1	5224	SS	5984	AG	6452
Runoff 54w 36d	DZEG5436	HP	5197	W1	5399	SS	6311	AG	6895
• Runoff 60w 30d	DZEG6030	HP	5068	W1	5270	SS	6115	AG	6645
Runoff 60w 36d	DZEG6036	HP	5258	W1	5454	SS	6468	AG	7128
Runoff 66w 30d	DZEG6630	HP	5114	W1	5316	SS	6245	AG	6840
Runoff 66w 36d	DZEG6636	HP	5315	W1	5508	SS	6624	AG	7360
Runoff 72w 30d	DZEG7230	HP	5164	W1	5361	SS	6375	AG	7036
Runoff 72w 36d	DZEG7236	HP	5372	W1	5564	SS	6780	AG	7595

! Notes:

Top finishes are listed above; specify Wood1 finish for elements below worksurface.
 Glass tops have metal edges; MRBAS, Metal Resin Brushed Aluminum w/ Steel Tint; HPL tops have PVC edges; all other tops are self-edged.
 Standard HPL top material is Formica 949 White Matte.
 Standard Solid Surface material is Avonite Polaris White, Matte.
 Mitre folded plinth construction.
 OcuWrite Back-Painted Glass color: O.BWT White.

+ Options:

Specify Wood1 finish for End Panel and Modesty.
 Specify L, for left; or R, for right hand runoff. Place at the end of product number.
 Specify White, Silver or Black for height adjustable leg color.
 To add metal edge to Wood, Laminate or Acrylic Solid Surface tops, add ME to the end of Spec code, and price that correlates to top size from metal edge table.
 Metal edge table is located just below Top options.

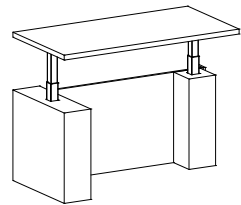

Runoff, Ped & Plinth 29.9-48.4h
Height Adjustable

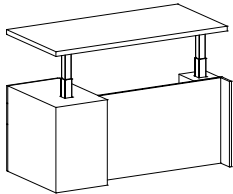

Right Hand

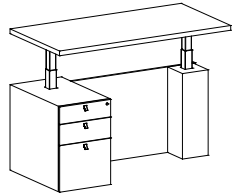

Left Hand

Description	Product No.	Spec Code	List \$	Spec Code	List \$	Spec Code	List \$	Spec Code	List \$
		HPL Top		Wood1 Top		Solid Surface Top		OcuWrite Top	
Runoff 48w 30d	DZG?4830	HP	5650	W1	5856	SS	6532	AG	5669
Runoff 48w 36d	DZG?4836	HP	6033	W1	6236	SS	7047	AG	6033
Runoff 54w 30d	DZG?5430	HP	5699	W1	5904	SS	6662	AG	5716
Runoff 54w 36d	DZG?5436	HP	6090	W1	6290	SS	7202	AG	6090
Runoff 60w 30d	DZG?6030	HP	5747	W1	5949	SS	6793	AG	5765
Runoff 60w 36d	DZG?6036	HP	6149	W1	6345	SS	7359	AG	6148
Runoff 66w 30d	DZG?6630	HP	5794	W1	5994	SS	6923	AG	5814
Runoff 66w 36d	DZG?6636	HP	6206	W1	6401	SS	7516	AG	6205
Runoff 72w 30d	DZG?7230	HP	5843	W1	6041	SS	7054	AG	5861
Runoff 72w 36d	DZG?7236	HP	6264	W1	6456	SS	7673	AG	6262

! Notes:

Mitre folded pedestal and plinth construction.

Top finishes are listed above; specify Wood1 finish for elements below worksurface.

All runoff pedestals are 18w 20d.

Glass tops have metal edges; MRBAS, Metal Resin Brushed Aluminum w/ Steel Tint; HPL tops have PVC edges; all other tops are self-edged.

Standard HPL top material is Formica 949 White Matte.

Standard Solid Surface material is Avonite Polaris White, Matte.

OcuWrite Back-Painted Glass color: O.BWT White.

Acrylic faces are Stylelite Arctic White standard.

Locks included.

+ Options:

To add B/B/F left, append 4th digit to A and add \$1921 to total.

To add B/B/F right, append 4th digit to B and add \$1921 to total.

Specify Wood1 finish for End Panel and Modesty.

Specify White, Silver or Black for height adjustable leg color.

To add metal edge to Wood, Laminate or Acrylic Solid Surface tops, add ME to the end of Spec code, and price that correlates to top size from metal edge table.

Metal edge table is located just below Top options.

To add acrylic faces, append A to end of Product Code, and add \$437 List.

Pull finish is standard MRBAS, Brushed Aluminum w/Steel tint; for polished specify MPA, Polished Aluminum.

Runoff, T-Leg 29.9-48.4h
Height Adjustable

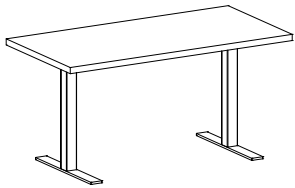

Description	Product No.	Spec Code	List \$	Spec Code	List \$	Spec Code	List \$	Spec Code	List \$
		HPL Top		Wood1 Top		Solid Surface Top		OcuWrite Top	
Runoff 48w 30d	DZEH4830	HP	3612	W1	3988	SS	4960	AG	5363
Runoff 48w 36d	DZEH4836	HP	3688	W1	4061	SS	5167	AG	5675
Runoff 54w 30d	DZEH5430	HP	3659	W1	4033	SS	5089	AG	5557
Runoff 54w 36d	DZEH5436	HP	3745	W1	4116	SS	5324	AG	5907
• Runoff 60w 30d	DZEH6030	HP	3708	W1	4081	SS	5219	AG	5753
Runoff 60w 36d	DZEH6036	HP	3804	W1	4171	SS	5481	AG	6141
Runoff 66w 30d	DZEH6630	HP	3755	W1	4126	SS	5350	AG	5946
Runoff 66w 36d	DZEH6636	HP	3862	W1	4226	SS	5635	AG	6374
Runoff 72w 30d	DZEH7230	HP	3804	W1	4171	SS	5481	AG	6141
Runoff 72w 36d	DZEH7236	HP	3919	W1	4282	SS	5792	AG	6608

! Notes:

- Standard HPL top material is Formica 949 White Matte.
- Standard Solid Surface material is Avonite Polaris White, Matte.
- OcuWrite Back-Painted Glass color: O.BWT White.
- Top finishes are listed above; specify Wood1 finish for elements below worksurface where applicable.
- Plinth bases are mitre folded construction. Available on 3 leg desk only.
- Plinth bases are priced in Wood1 options.

+ Options:

- Specify leg color: White, Black or Silver.
- Specify L for left; or R for right hand runoff. Place at the end of product number.

Runoff, Plinth 29.9-48.4h
Height Adjustable

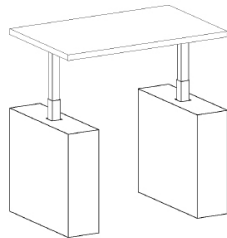
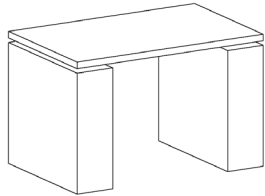

Description	Product No.	Spec Code	List \$	Spec Code	List \$	Spec Code	List \$	Spec Code	List \$
		HPL Top		Wood1 Top		Solid Surface Top		OcuWrite Top	
Runoff 48w 30d	DZEP4830	HP	5996	W1	6265	SS	7223	AG	8249
Runoff 48w 36d	DZEP4836	HP	6250	W1	6509	SS	7482	AG	8507
Runoff 54w 30d	DZEP5430	HP	6108	W1	6372	SS	7363	AG	8517
Runoff 54w 36d	DZEP5436	HP	6340	W1	6598	SS	7622	AG	8776
• Runoff 60w 30d	DZEP6030	HP	6198	W1	6462	SS	7503	AG	8786
Runoff 60w 36d	DZEP6036	HP	6429	W1	6683	SS	7752	AG	9035
Runoff 66w 30d	DZEP6630	HP	6288	W1	6546	SS	7634	AG	9045
Runoff 66w 36d	DZEP6636	HP	6365	W1	6772	SS	7888	AG	9299
Runoff 72w 30d	DZEP7230	HP	6377	W1	6634	SS	7770	AG	9308
Runoff 72w 36d	DZEP7236	HP	6653	W1	6862	SS	8033	AG	9571

! Notes:

- Standard HPL top material is Formica 949 White Matte.
- Standard Solid Surface material is Avonite Polaris White, Matte.
- OcuWrite Back-Painted Glass color: O.BWT White.
- Top finishes are listed above; specify Wood1 finish for elements below worksurface where applicable.
- Plinth bases are mitre folded construction.
- Plinth bases are priced in Wood1 options.

+ Options:

- Specify leg color: White, Black or Silver.

Computer Corner, T Legs 29.9-48.4h
Height Adjustable

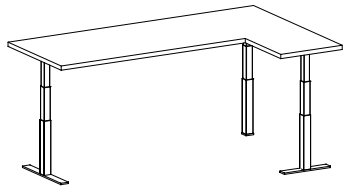

Description	Product No.	Spec Code	List \$	Spec Code	List \$
		HPL Top		Wood1 Top	
Corner 72w 30d x 48w 20d	DZEJ72304820	HP	4525	W1	4880
Corner 72w 36d x 48w 24d	DZEJ72364824	HP	4690	W1	5038
Corner 78w 30d x 48w 20d	DZEJ78304820	HP	4572	W1	4925
Corner 78w 36d x 48w 24d	DZEJ78364824	HP	4747	W1	5094
Corner 84w 30d x 48w 20d	DZEJ84304820	HP	4620	W1	4971
Corner 84w 36d x 48w 24d	DZEJ84364824	HP	4807	W1	5149
Corner 96w 30d x 48w 20d	DZEJ96304820	HP	4717	W1	5061
Corner 96w 36d x 48w 24d	DZEJ96364824	HP	4921	W1	5259
		HPL Top		Wood1 Top	
Corner 72w 30d x 54w 20d	DZEJ72305420	HP	4555	W1	4910
Corner 72w 36d x 54w 24d	DZEJ72365424	HP	4728	W1	5074
Corner 78w 30d x 54w 20d	DZEJ78305420	HP	4604	W1	4955
Corner 78w 36d x 54w 24d	DZEJ78365424	HP	4787	W1	5129
Corner 84w 30d x 54w 20d	DZEJ84305420	HP	4651	W1	5001
Corner 84w 36d x 54w 24d	DZEJ84365424	HP	4846	W1	5184
Corner 96w 30d x 54w 20d	DZEJ96305420	HP	4747	W1	5094
Corner 96w 36d x 54w 24d	DZEJ96365424	HP	4961	W1	5294
		HPL Top		Wood1 Top	
Corner 72w 30d x 60w 20d	DZEJ72306020	HP	4587	W1	4939
Corner 72w 36d x 60w 24d	DZEJ72366024	HP	4768	W1	5111
Corner 78w 30d x 60w 20d	DZEJ78306020	HP	4637	W1	4987
Corner 78w 36d x 60w 24d	DZEJ78366024	HP	4826	W1	5166
Corner 84w 30d x 60w 20d	DZEJ84306020	HP	4685	W1	5032
Corner 84w 36d x 60w 24d	DZEJ84366024	HP	4883	W1	5222
Corner 96w 30d x 60w 20d	DZEJ96306020	HP	4780	W1	5124
• Corner 96w 36d x 60w 24d	DZEJ96366024	HP	4999	W1	5331

! Notes:

- Standard HPL top material is Formica 949 White Matte.
- Standard Solid Surface material is Avonite Polaris White, Matte.
- OcuWrite Back-Painted Glass color: O.BWT White.
- Top finishes are listed above; specify Wood1 finish for elements below worksurface where applicable.
- Plinth bases are mitre folded construction. Available on 3 leg desk only.
- Plinth bases are priced in Wood1 options.

+ Options:

- Specify leg color: White, Black or Silver.
- Specify L for left; or R for right hand runoff. Place at the end of product number.

Computer Corner, Plinth Bases 29.9-48.4h
Height Adjustable

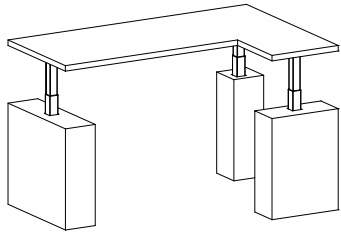

Description	Product No.	Spec Code	List \$	Spec Code	List \$
		HPL Top		Wood1 Top	
• Corner 72w 30d x 48w 20d	DZEK72304820	HP	6824	W1	7179
Corner 72w 36d x 48w 24d	DZEK72364824	HP	6990	W1	7336
Corner 78w 30d x 48w 20d	DZEK78304820	HP	6870	W1	7223
Corner 78w 36d x 48w 24d	DZEK78364824	HP	7047	W1	7391
Corner 84w 30d x 48w 20d	DZEK84304820	HP	6919	W1	7269
Corner 84w 36d x 48w 24d	DZEK84364824	HP	7105	W1	7446
Corner 96w 30d x 48w 20d	DZEK96304820	HP	7016	W1	7360
Corner 96w 36d x 48w 24d	DZEK96364824	HP	7221	W1	7557
		HPL Top		Wood1 Top	
Corner 72w 30d x 54w 20d	DZEK72305420	HP	6855	W1	7210
Corner 72w 36d x 54w 24d	DZEK72365424	HP	7027	W1	7374
Corner 78w 30d x 54w 20d	DZEK78305420	HP	6902	W1	7253
Corner 78w 36d x 54w 24d	DZEK78365424	HP	7086	W1	7429
Corner 84w 30d x 54w 20d	DZEK84305420	HP	6951	W1	7301
Corner 84w 36d x 54w 24d	DZEK84365424	HP	7144	W1	7483
Corner 96w 30d x 54w 20d	DZEK96305420	HP	7047	W1	7391
Corner 96w 36d x 54w 24d	DZEK96365424	HP	7258	W1	7594
		HPL Top		Wood1 Top	
Corner 72w 30d x 60w 20d	DZEK72306020	HP	6886	W1	7239
Corner 72w 36d x 60w 24d	DZEK72366024	HP	7065	W1	7410
Corner 78w 30d x 60w 20d	DZEK78306020	HP	6935	W1	7285
Corner 78w 36d x 60w 24d	DZEK78366024	HP	7125	W1	7465
Corner 84w 30d x 60w 20d	DZEK84306020	HP	6983	W1	7331
Corner 84w 36d x 60w 24d	DZEK84366024	HP	7183	W1	7520
Corner 96w 30d x 60w 20d	DZEK96306020	HP	7080	W1	7422
Corner 96w 36d x 60w 24d	DZEK96366024	HP	7298	W1	7630

! Notes:

- Standard HPL top material is Formica 949 White Matte.
- Standard Solid Surface material is Avonite Polaris White, Matte.
- OcuWrite Back-Painted Glass color: O.BWT White.
- Top finishes are listed above; specify Wood1 finish for elements below worksurface where applicable.
- Plinth bases are mitre folded construction. Available on 3 leg desk only.
- Plinth bases are priced in Wood1 options.

+ Options:

- Specify leg color: White, Black or Silver.
- Specify L for left; or R for right hand runoff. Place at the end of product number.

Wall Hung Credenza 29.9-48.4h
 Height Adjustable
 Veneer Interior

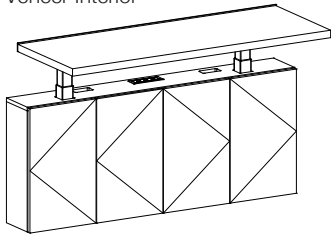

Description	Spec Code	List \$	Spec Code	List \$	Spec Code	List \$	Spec Code	List \$
	HPL Top		Wood1 Top		Solid Surface Top		OcuWrite Top	
Wall Hung 48w 24d	DZFA4824	HP 8073	W1	8455	SS	9187	AG	10476
Wall Hung 48w 30d	DZFA4830	HP 8865	W1	9242	SS	10082	AG	11575
Wall Hung 54w 24d	DZFA5424	HP 8423	W1	8804	SS	9603	AG	11017
Wall Hung 54w 30d	DZFA5430	HP 9255	W1	9632	SS	10557	AG	12186
• Wall Hung 60w 24d	DZFA6024	HP 8799	W1	9175	SS	10043	AG	11584
Wall Hung 60w 30d	DZFA6030	HP 9673	W1	10045	SS	11055	AG	12824
Wall Hung 66w 24d	DZFA6624	HP 9136	W1	9513	SS	10447	AG	12111
Wall Hung 66w 30d	DZFA6630	HP 10051	W1	10422	SS	11514	AG	13421
Wall Hung 72w 24d	DZFA7224	HP 9486	W1	9859	SS	10861	AG	12651
Wall Hung 72w 30d	DZFA7230	HP 10441	W1	10809	SS	11987	AG	14031
Wall Hung 78w 24d	DZFA7824	HP 9825	W1	10196	SS	11264	AG	13180
Wall Hung 78w 30d	DZFA7830	HP 10820	W1	11185	SS	12447	AG	14630

! Notes:

- Glass tops have metal edges; MRBAS, Metal Resin Brushed Aluminum w/ Steel Tint; HPL tops have PVC edges; all other tops are self-edged.
- Standard HPL top material is Formica 949 White Matte.
- Standard Solid Surface material is Avonite Polaris White, Matte.
- OcuWrite Back-Painted Glass color: O.BWT White.
- 24d units have a 9d base section.
- 30d units have a 15d base section.
- Vertical hinge door access standard on all units.
- All units must be attached to wall.
- Accessory power standard with Duplex and dual Charging USB, soft plug.
- Tops are included with wall hung units.
- No locks.
- Pencil catches are standard on Wall Hung Credenzas.
- Pencil catch finish standard as MRBAS, Brushed Aluminum w/Steel Tint.

+ Options:

- Specify White, Silver or Black for height adjustable leg color.
- To add metal edge to Wood, Laminate or Acrylic Solid Surface tops, add ME to the end of Spec code, and price that correlates to top size from metal edge table.

Wall Hung Credenza 29.9-48.4h
 Height Adjustable
 Cabinet Grade Interior

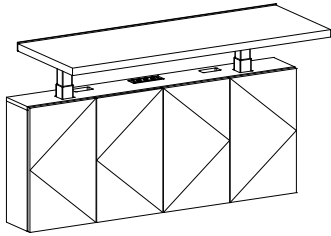

Description	Spec Code	List \$	Spec Code	List \$	Spec Code	List \$	Spec Code	List \$
	HPL Top		Wood1 Top		Solid Surface Top		OcuWrite Top	
Wall Hung 48w 24d	DZfZ4824	HP 5058	W1 5317	SS 6285	AG 7311			
Wall Hung 48w 30d	DZfZ4830	HP 5443	W1 5704	SS 6724	AG 8006			
Wall Hung 54w 24d	DZfZ5424	HP 5277	W1 5536	SS 6532	AG 7686			
Wall Hung 54w 30d	DZfZ5430	HP 5673	W1 5935	SS 7011	AG 8454			
• Wall Hung 60w 24d	DZfZ6024	HP 5469	W1 5728	SS 6775	AG 8057			
Wall Hung 60w 30d	DZfZ6030	HP 5886	W1 6143	SS 7271	AG 8874			
Wall Hung 66w 24d	DZfZ6624	HP 5867	W1 5919	SS 7013	AG 8423			
Wall Hung 66w 30d	DZfZ6630	HP 6387	W1 6373	SS 7554	AG 9317			
Wall Hung 72w 24d	DZfZ7224	HP 5867	W1 6120	SS 7260	AG 8798			
Wall Hung 72w 30d	DZfZ7230	HP 6387	W1 6599	SS 7841	AG 9764			
Wall Hung 78w 24d	DZfZ7824	HP 6108	W1 6316	SS 7511	AG 9178			
Wall Hung 78w 30d	DZfZ7830	HP 6613	W1 6821	SS 8119	AG 10203			

! Notes:

- Glass tops have metal edges; MRBAS, Metal Resin Brushed Aluminum w/ Steel Tint; HPL tops have PVC edges; all other tops are self-edged.
- Standard HPL top material is Formica 949 White Matte.
- Standard Solid Surface material is Avonite Polaris White, Matte.
- OcuWrite Back-Painted Glass color: O.BWT White.
- 24d units have a 9d base section.
- 30d units have a 15d base section.
- Vertical hinge door access standard on all units.
- All units must be attached to wall.
- Tops are included with wall hung units.
- No locks.
- Pencil catches are standard on Wall Hung Credenzas.
- Pencil catch finish standard as MRBAS, Brushed Aluminum w/Steel Tint.

+ Options:

- Specify White, Silver or Black for height adjustable leg color.
- To add metal edge to Wood, Laminate or Acrylic Solid Surface tops, add ME to the end of Spec code, and price that correlates to top size from metal edge table.
- To add Power, add "PWR" to end of Item Number; Add \$ 265 to total cost. Power includes, Duplex and dual Charging USB (A), soft plug.

Pedestals 22.4h

Description	Prod.No. List \$		Prod.No. List \$					
	20d		24d					
Low Pedestals	DZFB	\$ sum	DZFC	\$ sum				
Low Pedestals w/ Toe Kick	DZFBTK	\$ sum	DZFCTK	\$ sum				
	Spec Code	▲	Spec Code	▲	Spec Code	Add \$	Spec Code	Add \$
	Wood1 Faces		Wood1 Faces		Acrylic Faces		Finished Back	
Shelving 16w	A16	1332	A16	1387	—	—	FB	71
• Shelving 18w	A18	1372	A18	1426	—	—	FB	79
Shelving 20w	A20	1411	A20	1465	—	—	FB	88
Shelving 24w	A24	1492	A24	1546	—	—	FB	106
Shelving 30w	A30	1611	A30	1667	—	—	FB	133
Shelving 36w	A36	1730	A36	1785	—	—	FB	158
Cabinet 16w LH	CL16	1819	CL16	1875	A	416	FB	71
Cabinet 16w RH	CR16	1819	CR16	1875	A	416	FB	71
• Cabinet 18w LH	CL18	1873	CL18	1929	A	416	FB	79
Cabinet 18w RH	CR18	1873	CR18	1929	A	416	FB	79
Cabinet 20w LH	CL20	1927	CL20	1982	A	416	FB	88
Cabinet 20w RH	CR20	1927	CR20	1982	A	416	FB	88
Cabinet 24w DBL	C24	2073	C24	2128	A	416	FB	106
Cabinet 30w DBL	C30	2212	C30	2287	A	416	FB	133
Cabinet 36w DBL	C36	2393	C36	2448	A	416	FB	158
Box/File 16w	R16	2011	R16	2107	A	416	FB	71
• Box/File 18w	R18	2032	R18	2112	A	416	FB	79
Box/File 20w	R20	2076	R20	2171	A	416	FB	88
Box/File 24w	R24	2124	R24	2224	A	416	FB	106
Box/File 30w	R30	2237	R30	2338	A	416	FB	133
Box/File 36w	R36	2334	R36	2437	A	416	FB	158
Open/File 16w	W16	1949	W16	2096	A	416	FB	71
• Open/File 18w	W18	1977	W18	2115	A	416	FB	79
Open/File 20w	W20	2016	W20	2174	A	416	FB	88
Open/File 24w	W24	2078	W24	2247	A	416	FB	106
Open/File 30w	W30	2195	W30	2382	A	416	FB	133
Open/File 36w	W36	2296	W36	2496	A	416	FB	158
Trash/Recycle 18w	T18	1938	T18	2056	A	416	FB	79
Trash/Recycle 20w	T20	2005	T20	2088	A	416	FB	88
Trash/Recycle 24w	T24	2067	T24	2174	A	416	FB	106

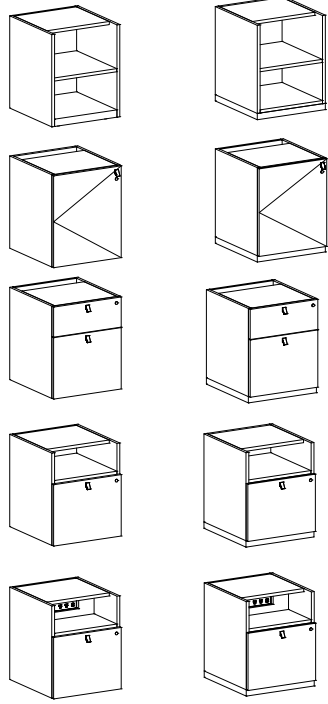

! Notes:



- All pedestals have unfinished backs and are manufactured as combined units.
- X4 extends the outer end panels 4 inches, to 24d, inside panels remain at 20d. Only available on 20d pedestals.
- Pull finish is standard MRBAS, for polished specify MPA, Polished Aluminum.
- Toe kick finish is standard MRBAS, Brushed Aluminum w/Steel Tint; for polished specify MPA, Polished Aluminum.
- Locks included standard.
- Power option on Open/File, includes (1) 60w USB-C, (2) Simplex and (2) Standard USB charging.
- Acrylic faces are Stylelite Arctic White standard.
- Trash/Recycle units 18w x 20d and 20w x 20d contain (1) Trash/Recycle bin.
- Trash/Recycle units 24w x 20d and all units 24d contain (2) Trash/Recycle bins.

+ Options:

- For pedestals with toe kick, use prefix code with toe kick.
- To extend the 20d pedestals on the end for wire passage, append X4 to end of the prefix code. Add, \$151.
- To add power to the Open/File pedestal, append PWR to the spec code; add \$1081.
- To change faces to Acrylic, add A to the spec code and add dollar amount for faces to total.
- To add finished back add FB and add dollar amount to total.
- For ventilation cutout add code VS, add \$437 to pedestal.

Grain Direction:
 Flat-cut veneers are applied vertically,
 quarter/rift-cut veneers horizontally.
 Other options on request.

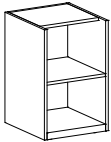
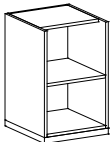
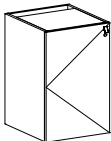
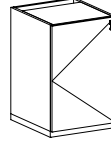
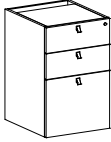
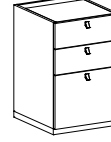
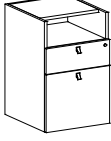
Pedestals 28.4h

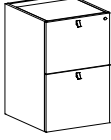
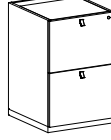
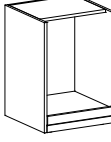
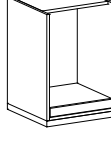
Description		Prod.No.	List \$	Prod.No.	List \$	Prod.No.	List \$	Prod.No.	List \$					
		20d		24d		30d		36d						
Pedestals		DZFD	\$ sum	DZFE	\$ sum	DZFF	\$ sum	DZFG	\$ sum					
Pedestals w/ Toe Kick		DZFDTK	\$ sum	DZFETK	\$ sum	DZFFTK	\$ sum	DZFGTK	\$ sum					
		Spec Code	▲	Spec Code	▲	Spec Code	▲	Spec Code	▲	Spec Code	Add \$	Spec Code	Add \$	
		Wood1 Faces		Wood1 Faces		Wood1 Faces		Wood1 Faces		Acrylic Faces		Finished Back		
		Shelving 16w	A16	1418	A16	1486	—	—	—	—	—	FB	88	
		• Shelving 18w	A18	1459	A18	1529	—	—	—	—	—	FB	100	
		Shelving 20w	A20	1502	A20	1570	—	—	—	—	—	FB	109	
		Shelving 24w	A24	1587	A24	1654	—	—	—	—	—	FB	133	
		Shelving 30w	A30	1712	A30	1781	—	—	—	—	—	FB	164	
		Shelving 36w	A36	1840	A36	1909	—	—	—	—	—	FB	197	
		Cabinet 16w LH	CL16	1905	CL16	1975	—	—	—	A	416	FB	88	
		Cabinet 16w RH	CR16	1905	CR16	1975	—	—	—	A	416	FB	88	
		• Cabinet 18w LH	CL18	1961	CL18	2030	—	—	—	A	416	FB	100	
		Cabinet 18w RH	CR18	1961	CR18	2030	—	—	—	A	416	FB	100	
		Cabinet 20w LH	CL20	2019	CL20	2087	—	—	—	A	416	FB	109	
		Cabinet 20w RH	CR20	2019	CR20	2087	—	—	—	A	416	FB	109	
		Cabinet 24w LH	CL24	2129	CL24	2197	—	—	—	A	416	FB	133	
		Cabinet 24w RH	CR24	2129	CR24	2197	—	—	—	A	416	FB	133	
		Cabinet 30w DBL	C30	2313	C30	2404	—	—	—	A	416	FB	164	
		Cabinet 36w DBL	C36	2503	C36	2572	—	—	—	A	416	FB	197	
		2Box/File 16w	H16	2313	H16	2422	H16	2737	H16	2826	A	416	FB	88
		• 2Box/File 18w	H18	2334	H18	2432	H18	2791	H18	2882	A	416	FB	100
		2Box/File 20w	H20	2393	H20	2505	H20	2825	H20	2921	A	416	FB	109
		2Box/File 24w	H24	2454	H24	2574	—	—	—	—	A	416	FB	133
		2Box/File 30w	H30	2599	H30	2718	—	—	—	—	A	416	FB	164
		2Box/File 36w	H36	2725	H36	2848	—	—	—	—	A	416	FB	197
		Open/Box/File 16w	X16	2259	X16	2426	X16	2684	X16	2809	A	416	FB	88
		• Open/Box/File 18w	X18	2289	X18	2447	X18	2741	X18	2871	A	416	FB	100
		Open/Box/File 20w	X20	2343	X20	2523	X20	2783	X20	2916	A	416	FB	109
		Open/Box/File 24w	X24	2417	X24	2611	—	—	—	—	A	416	FB	133
		Open/Box/File 30w	X30	2565	X30	2775	—	—	—	—	A	416	FB	164
		Open/Box/File 36w	X36	2697	X36	2922	—	—	—	—	A	416	FB	197
		File/File 16w	K16	2140	K16	2290	K16	2475	K16	2565	A	416	FB	88
		• File/File 18w	K18	2167	K18	2286	K18	2527	K18	2618	A	416	FB	100
		File/File 20w	K20	2216	K20	2366	K20	2558	K20	2655	A	416	FB	109
		File/File 24w	K24	2281	K24	2436	—	—	—	—	A	416	FB	133
		File/File 30w	K30	2430	K30	2586	—	—	—	—	A	416	FB	164
		File/File 36w	K36	2544	K36	2702	—	—	—	—	A	416	FB	197
		Utility Tray 16w	U16	1949	U16	2023	—	—	—	—	—	FB	88	
		• Utility Tray 18w	U18	1971	U18	2049	—	—	—	—	—	FB	100	
		Utility Tray 20w	U20	2009	U20	2085	—	—	—	—	—	FB	109	
		Utility Tray 24w	U24	2061	U24	2140	—	—	—	—	A	416	FB	133
		Utility Tray 30w	U30	2156	U30	2233	—	—	—	—	A	416	FB	164
		Utility Tray 36w	U36	2248	U36	2327	—	—	—	—	A	416	FB	197
		Trash/Recycle 18w	T18	2087	T18	2206	—	—	—	—	—	FB	100	
		Trash/Recycle 20w	T20	2116	T20	2235	—	—	—	—	—	FB	109	
		Trash/Recycle 24w	T24	2199	T24	2318	—	—	—	—	—	FB	133	

> See following page for Notes and Options.

Grain Direction:
 Flat-cut veneers are applied vertically,
 quarter/rift-cut veneers horizontally.
 Other options on request.

Modesty Panels

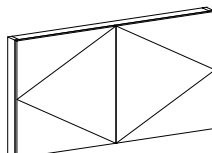
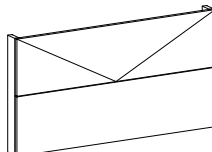
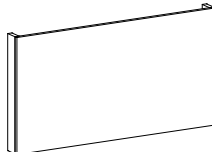
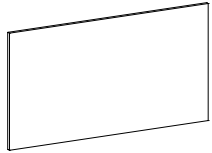

Description	Product No.	List \$	Product No.	List \$	Product No.	List \$	Product No.	List \$
22.4h			Fixed Finished Back 0.75d		Removable 3d		Horizontal Hinged 3d	Vertical Hinged 3d
ModPanel: Low Credenza 16w	DZGFA-16	520			DZGRA-16	597	—	—
ModPanel: Low Credenza 18w	DZGFA-18	534			DZGRA-18	610	—	—
ModPanel: Low Credenza 20w	DZGFA-20	547			DZGRA-20	625	—	—
ModPanel: Low Credenza 24w	DZGFA-24	575			DZGRA-24	652	—	—
ModPanel: Low Credenza 30w	DZGFA-30	614			DZGRA-30	693	—	—
ModPanel: Low Credenza 36w	DZGFA-36	657			DZGRA-36	734	DZGHA-36 1093	DZGVA-36 1183
ModPanel: Low Credenza 42w	DZGFA-42	697			DZGRA-42	775	DZGHA-42 1133	DZGVA-42 1225
ModPanel: Low Credenza 48w	DZGFA-48	738			DZGRA-48	816	DZGHA-48 1175	DZGVA-48 1266
ModPanel: Low Credenza 54w	DZGFA-54	779			DZGRA-54	856	DZGHA-54 1216	DZGVA-54 1307
ModPanel: Low Credenza 60w	DZGFA-60	821			DZGRA-60	1065	DZGHA-60 1479	DZGVA-60 1559
ModPanel: Low Credenza 72w	DZGFA-72	861			DZGRA-72	1105	DZGHA-72 1519	DZGVA-72 1600
ModPanel: Low Credenza 84w	—	—			DZGRA-84	1148	DZGHA-84 1561	DZGVA-84 1642
ModPanel: Low Credenza 96w	—	—			DZGRA-96	1188	DZGHA-96 1601	DZGVA-96 1683
ModPanel: Low Credenza 108w	—	—			DZGRA-108	1231	DZGHA-108 1643	DZGVA-108 1724
ModPanel: Low Credenza 120w	—	—			DZGRA-120	1271	DZGHA-120 1684	DZGVA-120 1764
28.4			Fixed Finished Back 0.75d		Removable 3d		Horizontal Hinged 3d	Vertical Hinged 3d
ModPanel: Credenza 16w	DZGFB-16	547			DZGRB-16	625	—	—
ModPanel: Credenza 18w	DZGFB-18	564			DZGRB-18	641	—	—
ModPanel: Credenza 20w	DZGFB-20	581			DZGRB-20	659	—	—
ModPanel: Credenza 24w	DZGFB-24	614			DZGRB-24	693	—	—
ModPanel: Credenza 30w	DZGFB-30	666			DZGRB-30	744	—	—
ModPanel: Credenza 36w	DZGFB-36	717			DZGRB-36	795	DZGHB-36 1154	DZGVB-36 1244
ModPanel: Credenza 42w	DZGFB-42	770			DZGRB-42	848	DZGHB-42 1206	DZGVB-42 1295
ModPanel: Credenza 48w	DZGFB-48	821			DZGRB-48	899	DZGHB-48 1257	DZGVB-48 1347
ModPanel: Credenza 54w	DZGFB-54	873			DZGRB-54	951	DZGHB-54 1308	DZGVB-54 1398
ModPanel: Credenza 60w	DZGFB-60	924			DZGRB-60	1204	DZGHB-60 1617	DZGVB-60 1698
ModPanel: Credenza 72w	DZGFB-72	975			DZGRB-72	1255	DZGHB-72 1668	DZGVB-72 1749
ModPanel: Credenza 84w	—	—			DZGRB-84	1307	DZGHB-84 1721	DZGVB-84 1800
ModPanel: Credenza 96w	—	—			DZGRB-96	1357	DZGHB-96 1772	DZGVB-96 1851
ModPanel: Credenza 108w	—	—			DZGRB-108	1408	DZGHB-108 1823	DZGVB-108 1902
ModPanel: Credenza 120w	—	—			DZGRB-120	1460	DZGHB-120 1873	DZGVB-120 1954

! Notes:

Panels over 54 inches come with T panel included.

Parametric pricing, use price of panel just larger than size needed, Replace dimension on Product number with actual dimension.

+ Options (for all except Fixed Finished Back panels):

For finished end left, add L to the product number.

Ex. For 16w 22.4h Removable ModPanel with finished end left, product number is DZGRA-16L

For finished end right, add R to the product number.

For finished both ends, add B to the product number.

Grain Direction:
Flat-cut veneers are applied vertically,
quarter/rift-cut veneers horizontally.
Other options on request.

Base Panels

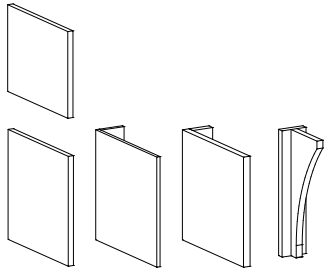

Description	Product No.	List \$	Product No.	List \$	Product No.	List \$	Product No.	List \$
22.4h	End Panels 1.5th		L-Panels 6w 0.75th		L-Panels 6w 1.5th		T-Panels 6w 1.5th	
Base Panel 20d 22.4h	DZHA20	598	DZHC20	589	DZHE20	646	DZHG20	696
Base Panel 24d 22.4h	DZHA24	646	DZHC24	614	DZHE24	692	DZHG24	743
• Base Panel 30d 22.4h	DZHA30	692	DZHC30	657	DZHE30	739	DZHG30	790
Base Panel 36d 22.4h	DZHA36	739	DZHC36	697	DZHE36	787	DZHG36	838
28.4h	End Panels 1.5th		L-Panels 6w 0.75th		L-Panels 6w 1.5th		T-Panels 6w 1.5th	
Base Panel 20d 28.4h	DZHB20	646	DZHD20	632	DZHF20	704	DZHH20	755
Base Panel 24d 28.4h	DZHB24	704	DZHD24	666	DZHF24	764	DZHH24	815
• Base Panel 30d 28.4h	DZHB30	764	DZHD30	717	DZHF30	822	DZHH30	873
Base Panel 36d 28.4h	DZHB36	822	DZHD36	770	DZHF36	879	DZHH36	930

! Notes:

End Panels to be used only next to pedestals.

L-Panels to be used when not next to a pedestal.

Specify L for left, or R for right hand End or L-panel. Place at the end of the Product number.

T-Panels must be used on open spans larger than 54w.

Top Supports

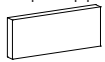

1.5th								
Top Supports 12w 4.5h	DZHJ12	511						
• Top Supports 15w 4.5h	DZHJ15	522						
Top Supports 18w 4.5h	DZHJ18	534						

! Notes:

Top supports assist in the transition of tops from standard height to low credenza height.

Tops, High Pressure Laminate

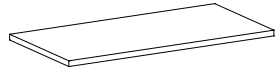

Description	Product No.	List \$	Product No.	List \$	Product No.	List \$	Product No.	List \$	Product No.	List \$	Product No.	List \$	Product No.	List \$
PVC Edge 1.5th	20d		24d		30d		36d		42d		48d		60d	
Top/Flat HPL:Self 16w	DZJA2016	708	DZJA2416	725	DZJA3016	749	DZJA3616	775	DZJA4216	801	DZJA4816	826	DZJA6016	878
Top/Flat HPL:Self 18w	DZJA2018	717	DZJA2418	737	DZJA3018	766	DZJA3618	795	DZJA4218	823	DZJA4818	852	DZJA6018	910
Top/Flat HPL:Self 20w	DZJA2020	730	DZJA2420	749	DZJA3020	783	DZJA3620	815	DZJA4220	846	DZJA4820	878	DZJA6020	942
Top/Flat HPL:Self 24w	DZJA2024	749	DZJA2424	775	DZJA3024	815	DZJA3624	852	DZJA4224	890	DZJA4824	929	DZJA6024	1007
Top/Flat HPL:Self 30w	DZJA2030	783	DZJA2430	815	DZJA3030	861	DZJA3630	910	DZJA4230	958	DZJA4830	1007	DZJA6030	1103
Top/Flat HPL:Self 36w	DZJA2036	815	DZJA2436	852	DZJA3036	910	DZJA3636	968	DZJA4236	1025	DZJA4836	1085	DZJA6036	1200
Top/Flat HPL:Self 42w	DZJA2042	846	DZJA2442	890	DZJA3042	958	DZJA3642	1025	DZJA4242	1094	DZJA4842	1161	DZJA6042	1295
Top/Flat HPL:Self 48w	DZJA2048	878	DZJA2448	929	DZJA3048	1007	DZJA3648	1085	DZJA4248	1161	DZJA4848	1238	DZJA6048	1392
Top/Flat HPL:Self 54w	DZJA2054	910	DZJA2454	968	DZJA3054	1053	DZJA3654	1143	DZJA4254	1229	DZJA4854	1314	DZJA6054	1487
• Top/Flat HPL:Self 60w	DZJA2060	942	DZJA2460	1007	DZJA3060	1103	DZJA3660	1200	DZJA4260	1295	DZJA4860	1392	DZJA6060	1584
Top/Flat HPL:Self 66w	DZJA2066	975	DZJA2466	1045	DZJA3066	1152	DZJA3666	1257	DZJA4266	1363	DZJA4866	1469	DZJA6066	1681
Top/Flat HPL:Self 72w	DZJA2072	1007	DZJA2472	1085	DZJA3072	1200	DZJA3672	1314	DZJA4272	1430	DZJA4872	1546	DZJA6072	1778
Top/Flat HPL:Self 78w	DZJA2078	1040	DZJA2478	1122	DZJA3078	1248	DZJA3678	1373	DZJA4278	1498	DZJA4878	1623	DZJA6078	1873
Top/Flat HPL:Self 84w	DZJA2084	1070	DZJA2484	1161	DZJA3084	1295	DZJA3684	1430	DZJA4284	1565	DZJA4884	1701	DZJA6084	1970
Top/Flat HPL:Self 90w	DZJA2090	1103	DZJA2490	1200	DZJA3090	1344	DZJA3690	1487	DZJA4290	1634	DZJA4890	1778	DZJA6090	2066
Top/Flat HPL:Self 96w	DZJA2096	1135	DZJA2496	1238	DZJA3096	1392	DZJA3696	1546	DZJA4296	1701	DZJA4896	1854	DZJA6096	2163
Top/Flat HPL:Self 102w	DZJA2102	1167	DZJA24102	1277	DZJA30102	1440	DZJA36102	1604	DZJA42102	1767	DZJA48102	1931	DZJA60102	2259
Top/Flat HPL:Self 108w	DZJA2108	1200	DZJA24108	1314	DZJA30108	1487	DZJA36108	1662	DZJA42108	1835	DZJA48108	2008	DZJA60108	2355
Top/Flat HPL:Self 114w	DZJA2114	1232	DZJA24114	1353	DZJA30114	1536	DZJA36114	1721	DZJA42114	1902	DZJA48114	2085	DZJA60114	2451
Top/Flat HPL:Self 120w	DZJA2120	1265	DZJA24120	1392	DZJA30120	1584	DZJA36120	1778	DZJA42120	1970	DZJA48120	2163	DZJA60120	2548



Description	Suffix Code.	Add \$	Suffix Code	Add \$	Suffix Code	Add \$	Suffix Code.	Add \$	Suffix Code	Add \$	Suffix Code	Add \$	Suffix Code	Add \$
Metal Edge 1.5th	20d		24d		30d		36d		42d		48d		60d	
Top/Flat HPL:Metal 16w	...ME	1023	...ME	1073	...ME	1147	...ME	1220	...ME	1293	...ME	1367	...ME	1514
Top/Flat HPL:Metal 18w	...ME	1047	...ME	1097	...ME	1171	...ME	1243	...ME	1318	...ME	1392	...ME	1538
Top/Flat HPL:Metal 20w	...ME	1073	...ME	1121	...ME	1197	...ME	1268	...ME	1342	...ME	1417	...ME	1564
Top/Flat HPL:Metal 24w	...ME	1121	...ME	1171	...ME	1243	...ME	1318	...ME	1392	...ME	1465	...ME	1614
Top/Flat HPL:Metal 30w	...ME	1197	...ME	1243	...ME	1318	...ME	1392	...ME	1465	...ME	1538	...ME	1687
Top/Flat HPL:Metal 36w	...ME	1268	...ME	1318	...ME	1392	...ME	1465	...ME	1538	...ME	1614	...ME	1760
Top/Flat HPL:Metal 42w	...ME	1342	...ME	1392	...ME	1465	...ME	1538	...ME	1614	...ME	1687	...ME	1834
Top/Flat HPL:Metal 48w	...ME	1417	...ME	1465	...ME	1538	...ME	1614	...ME	1687	...ME	1760	...ME	1909
Top/Flat HPL:Metal 54w	...ME	1488	...ME	1538	...ME	1614	...ME	1687	...ME	1760	...ME	1834	...ME	1981
Top/Flat HPL:Metal 60w	...ME	1564	...ME	1614	...ME	1687	...ME	1760	...ME	1834	...ME	1909	...ME	2055
Top/Flat HPL:Metal 66w	...ME	1638	...ME	1687	...ME	1760	...ME	1834	...ME	1909	...ME	1981	...ME	2129
Top/Flat HPL:Metal 72w	...ME	1711	...ME	1760	...ME	1834	...ME	1909	...ME	1981	...ME	2055	...ME	2202
Top/Flat HPL:Metal 78w	...ME	1784	...ME	1834	...ME	1909	...ME	1981	...ME	2055	...ME	2129	...ME	2276
Top/Flat HPL:Metal 84w	...ME	1859	...ME	1909	...ME	1981	...ME	2055	...ME	2129	...ME	2202	...ME	2351
Top/Flat HPL:Metal 90w	...ME	1932	...ME	1981	...ME	2055	...ME	2129	...ME	2202	...ME	2276	...ME	2423
Top/Flat HPL:Metal 96w	...ME	2005	...ME	2055	...ME	2129	...ME	2202	...ME	2276	...ME	2351	...ME	2496
Top/Flat HPL:Metal 102w	...ME	2079	...ME	2129	...ME	2202	...ME	2276	...ME	2351	...ME	2423	...ME	2572
Top/Flat HPL:Metal 108w	...ME	2154	...ME	2202	...ME	2276	...ME	2351	...ME	2423	...ME	2496	...ME	2645
Top/Flat HPL:Metal 114w	...ME	2226	...ME	2276	...ME	2351	...ME	2423	...ME	2496	...ME	2572	...ME	2718
Top/Flat HPL:Metal 120w	...ME	2301	...ME	2351	...ME	2423	...ME	2496	...ME	2572	...ME	2645	...ME	2792

! Notes:

- Standard HPL top material is Formica 949 White Matte.
- For metal edges, append ME to the Product No. and add the price shown above.
- > See page AD27 for additional Notes and Options.

Grain Direction:
 Flat-cut veneers are applied vertically,
 quarter/rift-cut veneers horizontally.
 Other options on request.

Tops, Wood 1

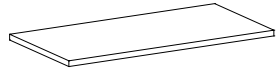

Description	Product No.	List \$	Product No.	List \$	Product No.	List \$	Product No.	List \$	Product No.	List \$	Product No.	List \$	Product No.	List \$
Self Edge, 1.5th	20d		24d		30d		36d		42d		48d		60d	
Top/Flat Wood1:Self 16w	DZJB2016	1099	DZJB2416	1116	DZJB3016	1139	DZJB3616	1164	DZJB4216	1188	DZJB4816	1214	DZJB6016	1261
Top/Flat Wood1:Self 18w	DZJB2018	1109	DZJB2418	1128	DZJB3018	1155	DZJB3618	1183	DZJB4218	1210	DZJB4818	1238	DZJB6018	1293
Top/Flat Wood1:Self 20w	DZJB2020	1120	DZJB2420	1139	DZJB3020	1171	DZJB3620	1201	DZJB4220	1232	DZJB4820	1261	DZJB6020	1323
Top/Flat Wood1:Self 24w	DZJB2024	1139	DZJB2424	1164	DZJB3024	1201	DZJB3624	1238	DZJB4224	1273	DZJB4824	1311	DZJB6024	1383
Top/Flat Wood1:Self 30w	DZJB2030	1171	DZJB2430	1201	DZJB3030	1245	DZJB3630	1293	DZJB4230	1339	DZJB4830	1383	DZJB6030	1476
Top/Flat Wood1:Self 36w	DZJB2036	1201	DZJB2436	1238	DZJB3036	1293	DZJB3636	1347	DZJB4236	1402	DZJB4836	1458	DZJB6036	1567
Top/Flat Wood1:Self 42w	DZJB2042	1232	DZJB2442	1273	DZJB3042	1339	DZJB3642	1402	DZJB4242	1466	DZJB4842	1531	DZJB6042	1659
Top/Flat Wood1:Self 48w	DZJB2048	1261	DZJB2448	1311	DZJB3048	1383	DZJB3648	1458	DZJB4248	1531	DZJB4848	1604	DZJB6048	1750
Top/Flat Wood1:Self 54w	DZJB2054	1293	DZJB2454	1347	DZJB3054	1430	DZJB3654	1513	DZJB4254	1595	DZJB4854	1677	DZJB6054	1842
• Top/Flat Wood1:Self 60w	DZJB2060	1323	DZJB2460	1383	DZJB3060	1476	DZJB3660	1567	DZJB4260	1659	DZJB4860	1750	DZJB6060	1933
Top/Flat Wood1:Self 66w	DZJB2066	1353	DZJB2466	1422	DZJB3066	1521	DZJB3666	1622	DZJB4266	1723	DZJB4866	1824	DZJB6066	2026
Top/Flat Wood1:Self 72w	DZJB2072	1383	DZJB2472	1458	DZJB3072	1567	DZJB3672	1677	DZJB4272	1788	DZJB4872	1897	DZJB6072	2118
Top/Flat Wood1:Self 78w	DZJB2078	1415	DZJB2478	1494	DZJB3078	1614	DZJB3678	1732	DZJB4278	1851	DZJB4878	1971	DZJB6078	2208
Top/Flat Wood1:Self 84w	DZJB2084	1446	DZJB2484	1531	DZJB3084	1659	DZJB3684	1788	DZJB4284	1916	DZJB4884	2043	DZJB6084	2301
Top/Flat Wood1:Self 90w	DZJB2090	1476	DZJB2490	1567	DZJB3090	1705	DZJB3690	1842	DZJB4290	1980	DZJB4890	2118	DZJB6090	2392
Top/Flat Wood1:Self 96w	DZJB2096	1505	DZJB2496	1604	DZJB3096	1750	DZJB3696	1897	DZJB4296	2043	DZJB4896	2191	DZJB6096	2486
Top/Flat Wood1:Self 102w	DZJB2102	1537	DZJB24102	1640	DZJB30102	1796	DZJB36102	1952	DZJB42102	2109	DZJB48102	2263	DZJB60102	2575
Top/Flat Wood1:Self 108w	DZJB2108	1567	DZJB24108	1677	DZJB30108	1842	DZJB36108	2006	DZJB42108	2173	DZJB48108	2337	DZJB60108	2667
Top/Flat Wood1:Self 114w	DZJB2114	1598	DZJB24114	1713	DZJB30114	1888	DZJB36114	2061	DZJB42114	2235	DZJB48114	2410	DZJB60114	2759
Top/Flat Wood1:Self 120w	DZJB2120	1627	DZJB24120	1750	DZJB30120	1933	DZJB36120	2118	DZJB42120	2301	DZJB48120	2486	DZJB60120	2852

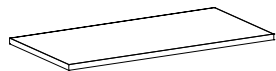

Description	Suffix Code.	Add \$	Suffix Code	Add \$	Suffix Code	Add \$	Suffix Code.	Add \$	Suffix Code	Add \$	Suffix Code	Add \$	Suffix Code	Add \$
Metal Edge 1.5th	20d		24d		30d		36d		42d		48d		60d	
Top/Flat Wood1: Metal 16w	...ME	1023	...ME	1073	...ME	1147	...ME	1220	...ME	1293	...ME	1367	...ME	1514
Top/Flat Wood1: Metal 18w	...ME	1047	...ME	1097	...ME	1171	...ME	1243	...ME	1318	...ME	1392	...ME	1538
Top/Flat Wood1: Metal 20w	...ME	1073	...ME	1121	...ME	1197	...ME	1268	...ME	1342	...ME	1417	...ME	1564
Top/Flat Wood1: Metal 24w	...ME	1121	...ME	1171	...ME	1243	...ME	1318	...ME	1392	...ME	1465	...ME	1614
Top/Flat Wood1: Metal 30w	...ME	1197	...ME	1243	...ME	1318	...ME	1392	...ME	1465	...ME	1538	...ME	1687
Top/Flat Wood1: Metal 36w	...ME	1268	...ME	1318	...ME	1392	...ME	1465	...ME	1538	...ME	1614	...ME	1760
Top/Flat Wood1: Metal 42w	...ME	1342	...ME	1392	...ME	1465	...ME	1538	...ME	1614	...ME	1687	...ME	1834
Top/Flat Wood1: Metal 48w	...ME	1417	...ME	1465	...ME	1538	...ME	1614	...ME	1687	...ME	1760	...ME	1909
Top/Flat Wood1: Metal 54w	...ME	1488	...ME	1538	...ME	1614	...ME	1687	...ME	1760	...ME	1834	...ME	1981
Top/Flat Wood1: Metal 60w	...ME	1564	...ME	1614	...ME	1687	...ME	1760	...ME	1834	...ME	1909	...ME	2055
Top/Flat Wood1: Metal 66w	...ME	1638	...ME	1687	...ME	1760	...ME	1834	...ME	1909	...ME	1981	...ME	2129
Top/Flat Wood1: Metal 72w	...ME	1711	...ME	1760	...ME	1834	...ME	1909	...ME	1981	...ME	2055	...ME	2202
Top/Flat Wood1: Metal 78w	...ME	1784	...ME	1834	...ME	1909	...ME	1981	...ME	2055	...ME	2129	...ME	2276
Top/Flat Wood1: Metal 84w	...ME	1859	...ME	1909	...ME	1981	...ME	2055	...ME	2129	...ME	2202	...ME	2351
Top/Flat Wood1: Metal 90w	...ME	1932	...ME	1981	...ME	2055	...ME	2129	...ME	2202	...ME	2276	...ME	2423
Top/Flat Wood1: Metal 96w	...ME	2005	...ME	2055	...ME	2129	...ME	2202	...ME	2276	...ME	2351	...ME	2496
Top/Flat Wood1: Metal 102w	...ME	2079	...ME	2129	...ME	2202	...ME	2276	...ME	2351	...ME	2423	...ME	2572
Top/Flat Wood1: Metal 108w	...ME	2154	...ME	2202	...ME	2276	...ME	2351	...ME	2423	...ME	2496	...ME	2645
Top/Flat Wood1: Metal 114w	...ME	2226	...ME	2276	...ME	2351	...ME	2423	...ME	2496	...ME	2572	...ME	2718
Top/Flat Wood1: Metal 120w	...ME	2301	...ME	2351	...ME	2423	...ME	2496	...ME	2572	...ME	2645	...ME	2792

! Notes:

- Standard HPL top material is Formica 949 White Matte.
- For metal edges, append ME to the Product No. and add the price shown above.
- > See page AD27 for additional Notes and Options.

Grain Direction:
 Flat-cut veneers are applied vertically,
 quarter/rift-cut veneers horizontally.
 Other options on request.

Tops, Acrylic Solid Surface

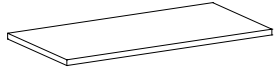

Description	Product No.	List \$	Product No.	List \$	Product No.	List \$	Product No.	List \$	Product No.	List \$	Product No.	List \$	Product No.	List \$
Self Edge, 1.5th	20d		24d		30d		36d		42d		48d		60d	
Top/Flat SolidS:Self 16w	DZJC2016	1544	DZJC2416	1591	DZJC3016	1659	DZJC3616	1729	DZJC4216	1800	DZJC4816	1868	DZJC6016	2006
Top/Flat SolidS:Self 18w	DZJC2018	1572	DZJC2418	1625	DZJC3018	1704	DZJC3618	1781	DZJC4218	1860	DZJC4818	1938	DZJC6018	2094
Top/Flat SolidS:Self 20w	DZJC2020	1601	DZJC2420	1659	DZJC3020	1747	DZJC3620	1834	DZJC4220	1920	DZJC4820	2006	DZJC6020	2180
Top/Flat SolidS:Self 24w	DZJC2024	1659	DZJC2424	1729	DZJC3024	1834	DZJC3624	1938	DZJC4224	2042	DZJC4824	2146	DZJC6024	2355
Top/Flat SolidS:Self 30w	DZJC2030	1747	DZJC2430	1834	DZJC3030	1965	DZJC3630	2094	DZJC4230	2225	DZJC4830	2355	DZJC6030	2614
Top/Flat SolidS:Self 36w	DZJC2036	1834	DZJC2436	1938	DZJC3036	2094	DZJC3636	2251	DZJC4236	2408	DZJC4836	2562	DZJC6036	2876
Top/Flat SolidS:Self 42w	DZJC2042	1920	DZJC2442	2042	DZJC3042	2225	DZJC3642	2408	DZJC4242	2589	DZJC4842	2771	DZJC6042	3136
Top/Flat SolidS:Self 48w	DZJC2048	2006	DZJC2448	2146	DZJC3048	2355	DZJC3648	2562	DZJC4248	2771	DZJC4848	2980	DZJC6048	3398
Top/Flat SolidS:Self 54w	DZJC2054	2094	DZJC2454	2251	DZJC3054	2486	DZJC3654	2719	DZJC4254	2955	DZJC4854	3188	DZJC6054	3658
• Top/Flat SolidS:Self 60w	DZJC2060	2180	DZJC2460	2355	DZJC3060	2614	DZJC3660	2876	DZJC4260	3136	DZJC4860	3398	DZJC6060	3918
Top/Flat SolidS:Self 66w	DZJC2066	2268	DZJC2466	2460	DZJC3066	2746	DZJC3666	3031	DZJC4266	3318	DZJC4866	3605	DZJC6066	4178
Top/Flat SolidS:Self 72w	DZJC2072	2355	DZJC2472	2562	DZJC3072	2876	DZJC3672	3188	DZJC4272	3502	DZJC4872	3815	DZJC6072	4440
Top/Flat SolidS:Self 78w	DZJC2078	2442	DZJC2478	2667	DZJC3078	3007	DZJC3678	3345	DZJC4278	3683	DZJC4878	4023	DZJC6078	4700
Top/Flat SolidS:Self 84w	DZJC2084	2528	DZJC2484	2771	DZJC3084	3136	DZJC3684	3502	DZJC4284	3867	DZJC4884	4230	DZJC6084	4961
Top/Flat SolidS:Self 90w	DZJC2090	2614	DZJC2490	2876	DZJC3090	3266	DZJC3690	3658	DZJC4290	4047	DZJC4890	4440	DZJC6090	5222
Top/Flat SolidS:Self 96w	DZJC2096	2702	DZJC2496	2980	DZJC3096	3398	DZJC3696	3815	DZJC4296	4230	DZJC4896	4648	DZJC6096	5481
Top/Flat SolidS:Self 102w	DZJC2102	2790	DZJC24102	3084	DZJC30102	3528	DZJC36102	3970	DZJC42102	4413	DZJC48102	4857	DZJC60102	5741
Top/Flat SolidS:Self 108w	DZJC2108	2876	DZJC24108	3188	DZJC30108	3658	DZJC36108	4126	DZJC42108	4595	DZJC48108	5066	DZJC60108	6002
Top/Flat SolidS:Self 114w	DZJC2114	2962	DZJC24114	3293	DZJC30114	3788	DZJC36114	4283	DZJC42114	4778	DZJC48114	5274	DZJC60114	6262
Top/Flat SolidS:Self 120w	DZJC2120	3050	DZJC24120	3398	DZJC30120	3918	DZJC36120	4440	DZJC42120	4961	DZJC48120	5481	DZJC60120	6524

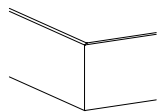

Description	↑	↑	↑	↑	↑	↑	↑	↑	↑	↑	↑	↑	↑	↑	
Suffix Code.	Add \$	Suffix Code	Add \$	Suffix Code	Add \$	Suffix Code	Add \$	Suffix Code	Add \$	Suffix Code	Add \$	Suffix Code	Add \$	Suffix Code	Add \$
Metal Edge 1.5th	20d		24d		30d		36d		42d		48d		60d		
Top/Flat SolidS:Metal 16w	...ME	1023	...ME	1073	...ME	1147	...ME	1220	...ME	1293	...ME	1367	...ME	1514	
Top/Flat SolidS:Metal 18w	...ME	1047	...ME	1097	...ME	1171	...ME	1243	...ME	1318	...ME	1392	...ME	1538	
Top/Flat SolidS:Metal 20w	...ME	1073	...ME	1121	...ME	1197	...ME	1268	...ME	1342	...ME	1417	...ME	1564	
Top/Flat SolidS:Metal 24w	...ME	1121	...ME	1171	...ME	1243	...ME	1318	...ME	1392	...ME	1465	...ME	1614	
Top/Flat SolidS:Metal 30w	...ME	1197	...ME	1243	...ME	1318	...ME	1392	...ME	1465	...ME	1538	...ME	1687	
Top/Flat SolidS:Metal 36w	...ME	1268	...ME	1318	...ME	1392	...ME	1465	...ME	1538	...ME	1614	...ME	1760	
Top/Flat SolidS:Metal 42w	...ME	1342	...ME	1392	...ME	1465	...ME	1538	...ME	1614	...ME	1687	...ME	1834	
Top/Flat SolidS:Metal 48w	...ME	1417	...ME	1465	...ME	1538	...ME	1614	...ME	1687	...ME	1760	...ME	1909	
Top/Flat SolidS:Metal 54w	...ME	1488	...ME	1538	...ME	1614	...ME	1687	...ME	1760	...ME	1834	...ME	1981	
Top/Flat SolidS:Metal 60w	...ME	1564	...ME	1614	...ME	1687	...ME	1760	...ME	1834	...ME	1909	...ME	2055	
Top/Flat SolidS:Metal 66w	...ME	1638	...ME	1687	...ME	1760	...ME	1834	...ME	1909	...ME	1981	...ME	2129	
Top/Flat SolidS:Metal 72w	...ME	1711	...ME	1760	...ME	1834	...ME	1909	...ME	1981	...ME	2055	...ME	2202	
Top/Flat SolidS:Metal 78w	...ME	1784	...ME	1834	...ME	1909	...ME	1981	...ME	2055	...ME	2129	...ME	2276	
Top/Flat SolidS:Metal 84w	...ME	1859	...ME	1909	...ME	1981	...ME	2055	...ME	2129	...ME	2202	...ME	2351	
Top/Flat SolidS:Metal 90w	...ME	1932	...ME	1981	...ME	2055	...ME	2129	...ME	2202	...ME	2276	...ME	2423	
Top/Flat SolidS:Metal 96w	...ME	2005	...ME	2055	...ME	2129	...ME	2202	...ME	2276	...ME	2351	...ME	2496	
Top/Flat SolidS:Metal 102w	...ME	2079	...ME	2129	...ME	2202	...ME	2276	...ME	2351	...ME	2423	...ME	2572	
Top/Flat SolidS:Metal 108w	...ME	2154	...ME	2202	...ME	2276	...ME	2351	...ME	2423	...ME	2496	...ME	2645	
Top/Flat SolidS:Metal 114w	...ME	2226	...ME	2276	...ME	2351	...ME	2423	...ME	2496	...ME	2572	...ME	2718	
Top/Flat SolidS:Metal 120w	...ME	2301	...ME	2351	...ME	2423	...ME	2496	...ME	2572	...ME	2645	...ME	2792	

! Notes:

Standard Solid Surface material is Avonite Polaris White, Matte.

For metal edges, append ME to the Product No. and add the price shown above.

> See page AD27 for additional Notes and Options.

Grain Direction:

Flat-cut veneers are applied vertically,
quarter/rift-cut veneers horizontally.
Other options on request.

Tops, OcuWrite BPGlass

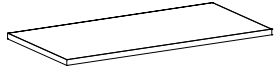

Description	Product No.	List \$	Product No.	List \$	Product No.	List \$	Product No.	List \$	Product No.	List \$	Product No.	List \$	Product No.	List \$
Metal Edge, 1.5th	20d		24d		30d		36d		42d		48d		60d	
Top/Flat OBPG: Metal 16w	DZJD2016	1991	DZJD2416	2109	DZJD3016	2285	DZJD3616	2464	DZJD4216	2641	DZJD4816	2819	DZJD6016	3174
Top/Flat OBPG: Metal 18w	DZJD2018	2057	DZJD2418	2185	DZJD3018	2376	DZJD3618	2565	DZJD4218	2755	DZJD4818	2946	DZJD6018	3327
Top/Flat OBPG: Metal 20w	DZJD2020	2126	DZJD2420	2262	DZJD3020	2465	DZJD3620	2668	DZJD4220	2872	DZJD4820	3074	DZJD6020	3483
Top/Flat OBPG: Metal 24w	DZJD2024	2262	DZJD2424	2415	DZJD3024	2644	DZJD3624	2873	DZJD4224	3102	DZJD4824	3331	DZJD6024	3791
Top/Flat OBPG: Metal 30w	DZJD2030	2465	DZJD2430	2644	DZJD3030	2912	DZJD3630	3180	DZJD4230	3449	DZJD4830	3716	DZJD6030	4254
Top/Flat OBPG: Metal 36w	DZJD2036	2668	DZJD2436	2873	DZJD3036	3180	DZJD3636	3487	DZJD4236	3795	DZJD4836	4100	DZJD6036	4717
Top/Flat OBPG: Metal 42w	DZJD2042	2872	DZJD2442	3102	DZJD3042	3449	DZJD3642	3795	DZJD4242	4142	DZJD4842	4486	DZJD6042	5179
Top/Flat OBPG: Metal 48w	DZJD2048	3074	DZJD2448	3331	DZJD3048	3716	DZJD3648	4100	DZJD4248	4486	DZJD4848	4874	DZJD6048	5643
Top/Flat OBPG: Metal 54w	DZJD2054	3278	DZJD2454	3562	DZJD3054	3985	DZJD3654	4409	DZJD4254	4832	DZJD4854	5258	DZJD6054	6104
• Top/Flat OBPG: Metal 60w	DZJD2060	3483	DZJD2460	3791	DZJD3060	4254	DZJD3660	4717	DZJD4260	5179	DZJD4860	5643	DZJD6060	6568
Top/Flat OBPG: Metal 66w	DZJD2066	3684	DZJD2466	4020	DZJD3066	4521	DZJD3666	5023	DZJD4266	5524	DZJD4866	6028	DZJD6066	7030
Top/Flat OBPG: Metal 72w	DZJD2072	3889	DZJD2472	4250	DZJD3072	4791	DZJD3672	5331	DZJD4272	5872	DZJD4872	6413	DZJD6072	7493
Top/Flat OBPG: Metal 78w	DZJD2078	4092	DZJD2478	4479	DZJD3078	5057	DZJD3678	5637	DZJD4278	6219	DZJD4878	6797	DZJD6078	7958
Top/Flat OBPG: Metal 84w	DZJD2084	4297	DZJD2484	4708	DZJD3084	5327	DZJD3684	5945	DZJD4284	6564	DZJD4884	7183	DZJD6084	8420
Top/Flat OBPG: Metal 90w	DZJD2090	4499	DZJD2490	4937	DZJD3090	5595	DZJD3690	6253	DZJD4290	6909	DZJD4890	7567	DZJD6090	8883
Top/Flat OBPG: Metal 96w	DZJD2096	4702	DZJD2496	5166	DZJD3096	5864	DZJD3696	6559	DZJD4296	7255	DZJD4896	7953	DZJD6096	9344
Top/Flat OBPG: Metal 102w	DZJD2102	4905	DZJD24102	5397	DZJD30102	6131	DZJD36102	6867	DZJD42102	7601	DZJD48102	8337	DZJD60102	9808
Top/Flat OBPG: Metal 108w	DZJD2108	5110	DZJD24108	5626	DZJD30108	6400	DZJD36108	7174	DZJD42108	7949	DZJD48108	8722	DZJD60108	10270
Top/Flat OBPG: Metal 114w	DZJD2114	5314	DZJD24114	5855	DZJD30114	6669	DZJD36114	7481	DZJD42114	8294	DZJD48114	9108	DZJD60114	10734
Top/Flat OBPG: Metal 120w	DZJD2120	5517	DZJD24120	6085	DZJD30120	6937	DZJD36120	7788	DZJD42120	8641	DZJD48120	9493	DZJD60120	11196

! Notes—Tops this page only:
 OcuWrite tops have a metal edge.
 OcuWrite Back-Painted Glass color is O.BWT White.

! Notes—All Tops:
 Metal edge finish standard as MRBAS, Brushed Aluminum w/Steel Tint.
 Metal edge will be on all edges of tops where applicable.
 Tops are 1 piece construction, so verify on larger tops that they will fit into space.

+ Options—All Tops:
 For Brush grommet/ Pencil Catch add BG to spec code and add \$7.00 per inch.
 Brush grommets/Pencil Catches, must be 12 inches smaller than full width of top, 6in from each end of top minimum.
 Ex. 72 inch top would get a max size brush grommet of 60 inch and the cost would be \$420.

Top Dividers

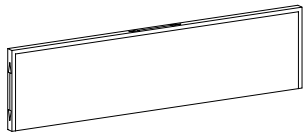
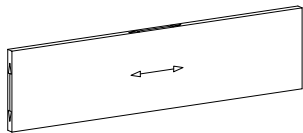
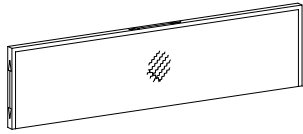

Description	COM yds	Product No.	List \$	Product No.	List \$	Product No.	List \$	Product No.	List \$
Fabric		12h		15h		20h		24h	
Fabric: Magnetic 20w	1.0	DZKA2012	1391	DZKA2015	1448	DZKA2020	1511	DZKA2024	1549
Fabric: Magnetic 24w	1.0	DZKA2412	1431	DZKA2415	1505	DZKA2420	1575	DZKA2424	1634
Fabric: Magnetic 30w	1.0	DZKA3012	1482	DZKA3015	1574	DZKA3020	1655	DZKA3024	1733
Fabric: Magnetic 36w	1.2	DZKA3612	1532	DZKA3615	1643	DZKA3620	1735	DZKA3624	1834
Fabric: Magnetic 42w	1.4	DZKA4212	1583	DZKA4215	1711	DZKA4220	1814	DZKA4224	1933
Fabric: Magnetic 48w	1.5	DZKA4812	1634	DZKA4815	1780	DZKA4820	1895	DZKA4824	2034
• Fabric: Magnetic 54w	1.7	DZKA5412	1683	DZKA5415	1848	DZKA5420	1974	DZKA5424	2134
Fabric: Magnetic 60w	1.9	DZKA6012	1733	DZKA6015	1918	DZKA6020	2055	DZKA6024	2234
Fabric: Magnetic 66w	2.0	DZKA6612	1783	DZKA6615	1986	DZKA6620	1644	DZKA6624	2336
Fabric: Magnetic 72w	2.2	DZKA7212	1834	DZKA7215	2055	DZKA7220	2214	DZKA7224	2437
Fabric: Magnetic 78w	2.4	DZKA7812	1884	DZKA7815	2123	DZKA7820	2295	DZKA7824	2537
Wood		12h		15h		20h		24h	
Wood: 20w		DZKB2012	1088	DZKB2015	1125	DZKB2020	1149	DZKB2024	1158
Wood: 24w		DZKB2412	1113	DZKB2415	1158	DZKB2420	1184	DZKB2424	1205
Wood: 30w		DZKB3012	1135	DZKB3015	1195	DZKB3020	1218	DZKB3024	1254
Wood: 36w		DZKB3612	1158	DZKB3615	1231	DZKB3620	1255	DZKB3624	1300
Wood: 42w		DZKB4212	1182	DZKB4215	1265	DZKB4220	1290	DZKB4224	1346
Wood: 48w		DZKB4812	1205	DZKB4815	1300	DZKB4820	1324	DZKB4824	1394
• Wood: 54w		DZKB5412	1231	DZKB5415	1336	DZKB5420	1361	DZKB5424	1442
Wood: 60w		DZKB6012	1254	DZKB6015	1370	DZKB6020	1396	DZKB6024	1487
Wood: 66w		DZKB6612	1277	DZKB6615	1406	DZKB6620	1431	DZKB6624	1535
Wood: 72w		DZKB7212	1300	DZKB7215	1442	DZKB7220	1465	DZKB7224	1583
Wood: 78w		DZKB7812	1323	DZKB7815	1476	DZKB7820	1502	DZKB7824	1628
OcuWrite BPGlass		12h		15h		20h		24h	
OcuWriteBPG: Magnetic 20w		DZKC2012	1914	DZKC2015	2102	DZKC2020	2382	DZKC2024	2595
OcuWriteBPG: Magnetic 24w		DZKC2412	2059	DZKC2415	2289	DZKC2420	2619	DZKC2424	2887
OcuWriteBPG: Magnetic 30w		DZKC3012	2267	DZKC3015	2552	DZKC3020	2961	DZKC3024	3299
OcuWriteBPG: Magnetic 36w		DZKC3612	2472	DZKC3615	2819	DZKC3620	3301	DZKC3624	3714
OcuWriteBPG: Magnetic 42w		DZKC4212	2680	DZKC4215	3083	DZKC4220	3643	DZKC4224	4127
OcuWriteBPG: Magnetic 48w		DZKC4812	2887	DZKC4815	3346	DZKC4820	3984	DZKC4824	4542
• OcuWriteBPG: Magnetic 54w		DZKC5412	3092	DZKC5415	3612	DZKC5420	4325	DZKC5424	4955
OcuWriteBPG: Magnetic 60w		DZKC6012	3299	DZKC6015	3875	DZKC6020	4666	DZKC6024	5369
OcuWriteBPG: Magnetic 66w		DZKC6612	3507	DZKC6615	4142	DZKC6620	1644	DZKC6624	5783
OcuWriteBPG: Magnetic 72w		DZKC7212	3714	DZKC7215	4404	DZKC7220	5348	DZKC7224	6197
OcuWriteBPG: Magnetic 78w		DZKC7812	3920	DZKC7815	4669	DZKC7820	5687	DZKC7824	6610

! Notes:

- All Dividers are two sided.
- All Dividers have a 0.75 Wood1 edge.
- OcuWrite Back-Painted Glass color: O.BWT White.
- Fabric panels are COM.
- Glass panels and Fabric panels are magnetic.
- Dividers are 1.5 inches thick.

Grain Direction:
 Flat-cut veneers are applied vertically,
 quarter/rift-cut veneers horizontally.
 Other options on request.

Hutches, Open Shelving

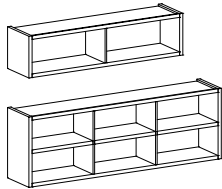

Description	Product No.	List \$	Product No.	List \$	Product No.	List \$	Product No.	List \$	Product No.	List \$	Product No.	List \$
18d	17.5h				29.5h							
Open Shelving 36w	DZLAA36	2816					DZLAB36	3655				
Open Shelving 48w	DZLAA48	2939					DZLAB48	3779				
Open Shelving 54w	DZLAA54	3000					DZLAB54	3840				
Open Shelving 60w	DZLAA60	3063					DZLAB60	3902				
Open Shelving 66w	DZLAA66	3124					DZLAB66	3998				
• Open Shelving 72w	DZLAA72	3185					DZLAB72	4095				
Open Shelving 78w	DZLAA78	3246					DZLAB78	4193				
Open Shelving 84w	DZLAA84	3309					DZLAB84	4289				
• Open Shelving 90w	DZLAA90	3370					DZLAB90	4386				
Open Shelving 96w	DZLAA96	3432					DZLAB96	4482				
Open Shelving 102w	DZLAA102	3492					DZLAB102	4581				
Open Shelving 108w	DZLAA108	3556					DZLAB108	4676				
Open Shelving 114w	DZLAA114	3618					DZLAB114	4774				
Open Shelving 120w	DZLAA120	3678					DZLAB120	4869				

Hutches, Cabinet Doors

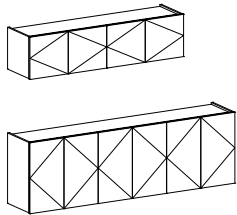

Description	#Doors	17.5h						29.5h					
		Wood1 Doors		Acrylic Doors		OcuWriteBPG Doors		Wood1 Doors		Acrylic Doors		OcuWrite BPG Doors	
Cabinet Doors 36w	2	DZLBW36	3067	DZLBA36	4113	DZLBG36	4560	DZLCW36	3906	DZLCA36	4952	DZLCG36	5766
Cabinet Doors 48w	3	DZLBW48	3252	DZLBA48	4299	DZLBG48	4785	DZLCW48	4092	DZLCA48	5138	DZLCG48	5939
Cabinet Doors 54w	3	DZLBW54	3344	DZLBA54	4390	DZLBG54	4896	DZLCW54	4183	DZLCA54	5230	DZLCG54	6024
Cabinet Doors 60w	3	DZLBW60	3436	DZLBA60	4482	DZLBG60	5010	DZLCW60	4277	DZLCA60	5322	DZLCG60	6110
Cabinet Doors 66w	4	DZLBW66	3551	DZLBA66	4596	DZLBG66	5280	DZLCW66	4404	DZLCA66	5451	DZLCG66	6442
• Cabinet Doors 72w	4	DZLBW72	3644	DZLBA72	4690	DZLBG72	5532	DZLCW72	4532	DZLCA72	5578	DZLCG72	6774
Cabinet Doors 78w	4	DZLBW78	3736	DZLBA78	4781	DZLBG78	5781	DZLCW78	4660	DZLCA78	5705	DZLCG78	7106
Cabinet Doors 84w	5	DZLBW84	3851	DZLBA84	4897	DZLBG84	6053	DZLCW84	4787	DZLCA84	5834	DZLCG84	7438
Cabinet Doors 90w	5	DZLBW90	3943	DZLBA90	6034	DZLBG90	6303	DZLCW90	4915	DZLCA90	7005	DZLCG90	7770
Cabinet Doors 96w	6	DZLBW96	4058	DZLBA96	6148	DZLBG96	6572	DZLCW96	5043	DZLCA96	7133	DZLCG96	8102
Cabinet Doors 102w	6	DZLBW102	4150	DZLBA102	6241	DZLBG102	6824	DZLCW102	5170	DZLCA102	7262	DZLCG102	8434
Cabinet Doors 108w	6	DZLBW108	4243	DZLBA108	6333	DZLBG108	7073	DZLCW108	5298	DZLCA108	7388	DZLCG108	8766
Cabinet Doors 114w	6	DZLBW114	4335	DZLBA114	6425	DZLBG114	7323	DZLCW114	5426	DZLCA114	7516	DZLCG114	9098
Cabinet Doors 120w	6	DZLBW120	4427	DZLBA120	6518	DZLBG120	7572	DZLCW120	5553	DZLCA120	7644	DZLCG120	9430

! Notes:

- Open End Options allowed on Open Shelving, Sliding Doors, and L Sliding Doors.
- For Open end left add A to the end of Product number.
- For Open end right add B to the end of the Product number.
- For Open end Both ends add C to the end of the Product number. Only allowed on 102w and greater.
- All Shelves are fixed, except for Cabinet door hutches.
- All Hutches come in one piece up to 120-in, please notify CSR if needed in 2 piece construction.
- Acrylic faces are Stylelite Arctic White standard.
- OcuWrite Back-Painted Glass color: O.BWT White.

Hutches, Sliding Doors

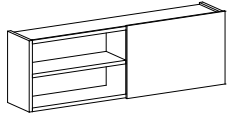
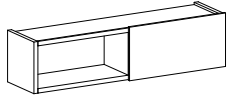

Description	COM yds	Product No.	List \$	17.5h			29.5h			Product No.	List \$	Product No.	List \$
				Product No.	List \$	Product No.	List \$	Product No.	List \$				
18d	#Doors	Wood1 Doors		Acrylic Doors		OcuWrite BPG Doors		Wood1 Doors		Acrylic Doors		OcuWrite BPG Doors	
Sliding Doors 48w	1	DZLDW48	3941	DZLDA48	4357	DZLDG48	4759	DZLEW48	4843	DZLEA48	5260	DZLEG48	5572
Sliding Doors 54w	1	DZLDW54	4003	DZLDA54	4419	DZLDG54	4823	DZLEW54	4939	DZLEA54	5355	DZLEG54	5662
Sliding Doors 60w	1	DZLDW60	4094	DZLDA60	4510	DZLDG60	4914	DZLEW60	5038	DZLEA60	5454	DZLEG60	5752
Sliding Doors 66w	1	DZLDW66	4188	DZLDA66	4604	DZLDG66	5170	DZLEW66	5186	DZLEA66	5601	DZLEG66	6103
• Sliding Doors 72w	1	DZLDW72	4280	DZLDA72	4695	DZLDG72	5439	DZLEW72	5333	DZLEA72	5749	DZLEG72	6455
Sliding Doors 78w	2	DZLDW78	4372	DZLDA78	4787	DZLDG78	5709	DZLEW78	5483	DZLEA78	5898	DZLEG78	6806
Sliding Doors 84w	2	DZLDW84	4465	DZLDA84	4881	DZLDG84	5979	DZLEW84	5630	DZLEA84	6046	DZLEG84	7156
Sliding Doors 90w	2	DZLDW90	4556	DZLDA90	4972	DZLDG90	6287	DZLEW90	5780	DZLEA90	6609	DZLEG90	7508
Sliding Doors 96w	2	DZLDW96	4649	DZLDA96	5066	DZLDG96	6517	DZLEW96	5927	DZLEA96	6757	DZLEG96	7859
Sliding Doors 102w	2	DZLDW102	5108	DZLDA102	5524	DZLDG102	7154	DZLEW102	6442	DZLEA102	7488	DZLEG102	8551
Sliding Doors 108w	2	DZLDW108	5200	DZLDA108	5617	DZLDG108	7384	DZLEW108	6590	DZLEA108	7635	DZLEG108	8902
Sliding Doors 114w	2	DZLDW114	5294	DZLDA114	5710	DZLDG114	7654	DZLEW114	6738	DZLEA114	7785	DZLEG114	9253
Sliding Doors 120w	2	DZLDW120	5386	DZLDA120	5802	DZLDG120	7923	DZLEW120	6886	DZLEA120	7932	DZLEG120	9604

Hutches, L-Sliding Door

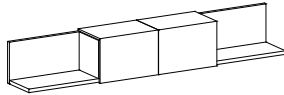

Description	COM yds	Product No.	List \$	17.5h			29.5h			Product No.	List \$	Product No.	List \$
				Product No.	List \$	Product No.	List \$	Product No.	List \$				
18d	#Doors	Wood1 Doors		Acrylic Doors		OcuWrite BPG Doors		Wood1 Doors		Acrylic Doors		OcuWrite BPG Doors	
L- Sliding Door 48w	1	DZLFW48	3821	DZLFA48	4237	DZLFG48	4640	---	---	---	---	---	---
L- Sliding Door 54w	1	DZLFW54	3902	DZLFA54	4318	DZLFG54	4722	---	---	---	---	---	---
L- Sliding Door 60w	1	DZLFW60	4059	DZLFA60	4475	DZLFG60	4879	---	---	---	---	---	---
L- Sliding Door 66w	1	DZLFW66	4140	DZLFA66	4555	DZLFG66	5123	---	---	---	---	---	---
L- Sliding Door 72w	1	DZLFW72	4221	DZLFA72	4637	DZLFG72	5381	---	---	---	---	---	---
L- Sliding Door 78w	1	DZLFW78	4376	DZLFA78	4793	DZLFG78	5714	---	---	---	---	---	---
L- Sliding Door 84w	1	DZLFW84	4510	DZLFA84	4926	DZLFG84	6024	---	---	---	---	---	---
L- Sliding Door 90w	1	DZLFW90	4590	DZLFA90	5422	DZLFG90	6321	---	---	---	---	---	---
L- Sliding Door 96w	1	DZLFW96	5004	DZLFA96	5836	DZLFG96	6872	---	---	---	---	---	---
• L- Sliding Door 102w	2	DZLFW102	5085	DZLFA102	5916	DZLFG102	7131	---	---	---	---	---	---
L- Sliding Door 108w	2	DZLFW108	5166	DZLFA108	5996	DZLFG108	7350	---	---	---	---	---	---
L- Sliding Door 114w	2	DZLFW114	5426	DZLFA114	6256	DZLFG114	7786	---	---	---	---	---	---
L- Sliding Door 120w	2	DZLFW120	5510	DZLFA120	6340	DZLFG120	8046	---	---	---	---	---	---

! Notes:

- Open End Options allowed on Open Shelving, Sliding Doors, and L Sliding Doors.
- For Open end left add A to the end of Product number.
- For Open end right add B to the end of the Product number.
- For Open end Both ends add C to the end of the Product number. Only allowed on 102w and greater.
- All Shelves are fixed, except for Cabinet door hutches.
- All Hutches come in one piece up to 120-in, please notify CSR if needed in 2 piece construction.
- Acrylic faces are Stylelite Arctic White standard.
- OcuWrite Back-Painted Glass color: O.BWT White.

Hutches, Bi-Pass Sliding Door

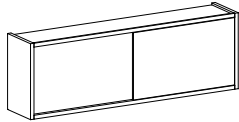
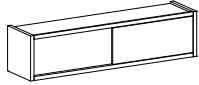

Description	Product No.	List \$	17.5h			29.5h		
			Product No.	List \$	Product No.	List \$	Product No.	List \$
			Wood1 Doors	Acrylic Doors	OcuWrite BPG Doors	Wood1 Doors	Acrylic Doors	OcuWrite BPG Doors
18d	#Doors							
Bi-Pass SlideDr 60w	2	DZLGW60 4303	DZLGA60 5349	—	—	DZLHW60 5348	DZLHA60 6394	—
Bi-Pass SlideDr 66w	2	DZLGW66 4395	DZLGA66 5440	—	—	DZLHW66 5495	DZLHA66 6541	—
• Bi-Pass SlideDr 72w	2	DZLGW72 4489	DZLGA72 5535	—	—	DZLHW72 5645	DZLHA72 6690	—
Bi-Pass SlideDr 78w	2	DZLGW78 4581	DZLGA78 5626	—	—	DZLHW78 5792	DZLHA78 6838	—
Bi-Pass SlideDr 84w	2	DZLGW84 4672	DZLGA84 5718	—	—	DZLHW84 5940	DZLHA84 6987	—
Bi-Pass SlideDr 90w	2	DZLGW90 4766	DZLGA90 6856	—	—	DZLHW90 6089	DZLHA90 8179	—
Bi-Pass SlideDr 96w	2	DZLGW96 4858	DZLGA96 6948	—	—	DZLHW96 6237	DZLHA96 8327	—
Bi-Pass SlideDr 102w	4	DZLGW102 4949	DZLGA102 7039	—	—	DZLHW102 6385	DZLHA102 8476	—
Bi-Pass SlideDr 108w	4	DZLGW108 5043	DZLGA108 7133	—	—	DZLHW108 6534	DZLHA108 8624	—
Bi-Pass SlideDr 114w	4	DZLGW114 5135	DZLGA114 7225	—	—	DZLHW114 6681	DZLHA114 8772	—
Bi-Pass SlideDr 120w	4	DZLGW120 5226	DZLGA120 7318	—	—	DZLHW120 6830	DZLHA120 8921	—

! Notes:

Bi-Pass Door hutches DO NOT allow for Legal Redweld.
 All Shelves are fixed, except for Cabinet door hutches.
 All Hutches come in one piece up to 120-in, please notify CSR if needed in 2 piece construction.
 Acrylic faces are Stylelite Arctic White standard.
 OcuWrite Back-Painted Glass color is O.BWT White.

Task Lights for Hutches



	w	Product No.	List \$
LED Lights 36w	30	DZLED36	585
LED Lights 48w	42	DZLED48	625
LED Lights 54w	48	DZLED54	663
LED Lights 60w	54	DZLED60	703
LED Lights 66w	60	DZLED66	742
LED Lights 72w	60	DZLED72	748
LED Lights 78w	72	DZLED78	804
LED Lights 84w	72	DZLED84	812
LED Lights 90w	84	DZLED90	868
LED Lights 96w	84	DZLED96	874
LED Lights 102w	96	DZLED102	961
LED Lights 108w	96	DZLED108	968
LED Lights 114w	108	DZLED114	1017
LED Lights 120w	108	DZLED120	1024

! Notes:

Order lights for the size of hutch.
 Switch is a wireless dimmer, located in worksurface unless otherwise specified.
 Lights are 3500k; Inquire with Customer Service for other Kelvin Temperatures.
 5.5 Watt/Ft
 615 Lumens/Ft
 115 Degree Beam Angle
 >90 Color Rendering Index (CRI)

Grain Direction:
 Flat-cut veneers are applied vertically,
 quarter/rift-cut veneers horizontally.
 Other options on request.

Description	#Shelves	Product No.	List \$	Product No.	List \$	Product No.	List \$	Product No.	List \$	Product No.	List \$	Product No.	List \$	Product No.	List \$	Product No.	List \$
Wall Panels, Wood1																	
	h	30w		36w		42w		48w		54w		60w		66w		72w	
Flush: Credenza: Hutch	25.1	1	DZMWA30 2495	DZMWA36 2602	DZMWA42 2709	DZMWA48 2819	DZMWA54 2926	DZMWA60 3034	DZMWA66 3140	DZMWA72 3248							
Flush: Low Credenza: Hutch	31.1	1	DZMWB30 2613	DZMWB36 2737	DZMWB42 2860	DZMWB48 2984	DZMWB54 3107	DZMWB60 3231	DZMWB66 3356	DZMWB72 3480							
Flush: Credenza: 60.5h oa	30.6	2	DZMWC30 2574	DZMWC36 2691	DZMWC42 2810	DZMWC48 2929	DZMWC54 3047	DZMWC60 3165	DZMWC66 3284	DZMWC72 3402							
Flush: Low Credenza: 60.5h oa	36.6	2	DZMWD30 2691	DZMWD36 2826	DZMWD42 2961	DZMWD48 3096	DZMWD54 3230	DZMWD60 3365	DZMWD66 3498	DZMWD72 3632							
Flush: Credenza: 72.5h oa	42.6	2	DZMWE30 2810	DZMWE36 2961	DZMWE42 3112	DZMWE48 3261	DZMWE54 3412	DZMWE60 3563	DZMWE66 3712	DZMWE72 3864							
Flush: Low Credenza: 72.5h oa	48.6	2	DZMWF30 2929	DZMWF36 3096	DZMWF42 3261	DZMWF48 3429	DZMWF54 3594	DZMWF60 3761	DZMWF66 3928	DZMWF72 4094							
Flush: Credenza: 84.5h oa	54.6	3	DZMWG30 3047	DZMWG36 3230	DZMWG42 3412	DZMWG48 3594	DZMWG54 3778	DZMWG60 3959	DZMWG66 4143	DZMWG72 4325							
Flush: Low Credenza: 84.5h oa	60.6	3	DZMWH30 3165	DZMWH36 3365	DZMWH42 3563	DZMWH48 3761	DZMWH54 3959	DZMWH60 4160	DZMWH66 4358	DZMWH72 4555							
Floor: Overhead	54.5	3	DZMWJ30 3047	DZMWJ36 3230	DZMWJ42 3412	DZMWJ48 3594	DZMWJ54 3778	DZMWJ60 3959	DZMWJ66 4143	DZMWJ72 4325							
Floor: 60.5h oa	60	4	DZMWK30 3165	DZMWK36 3365	DZMWK42 3563	DZMWK48 3761	DZMWK54 3959	DZMWK60 4160	DZMWK66 4358	DZMWK72 4555							
Floor: 72.5h oa	72	4	DZMWL30 3402	DZMWL36 3632	DZMWL42 3864	DZMWL48 4094	DZMWL54 4325	DZMWL60 4555									
Floor: 84.5h oa	84	5	DZMMW30 3639	DZMMW36 3902	DZMMW42 4165	DZMMW48 4427	DZMMW54 4690	DZMMW60 4953									
	h	78w		84w		90w		96w		102w		108w		114w		120w	
Flush: Credenza: Hutch	25.1	1	DZMWA78 3356	DZMWA84 3464	DZMWA90 3571	DZMWA96 3678	DZMWA102 3787	DZMWA108 3894	DZMWA114 4003	DZMWA120 4110							
Flush: Low Credenza: Hutch	31.1	1	DZMWB78 3603	DZMWB84 3727	DZMWB90 3850	DZMWB96 3974	DZMWB102 4098	DZMWB108 4222	DZMWB114 4345	DZMWB120 4469							
Flush: Credenza: 60.5h oa	30.6	2	DZMWC78 3520	DZMWC84 3639	DZMWC90 3759	DZMWC96 3875	DZMWC102 3995	DZMWC108 4113	DZMWC114 4232	DZMWC120 4350							
Flush: Low Credenza: 60.5h oa	36.6	2	DZMWD78 3767	DZMWD84 3902	DZMWD90 4037	DZMWD96 4171	DZMWD102 4306	DZMWD108 4441	DZMWD114 4573	DZMWD120 4708							
Flush: Credenza: 72.5h oa	42.6	2	DZMWE78 4014	DZMWE84 4165	DZMWE90 4316	DZMWE96 4466	DZMWE102 4616	DZMWE108 4768	DZMWE114 4916	DZMWE120 5068							
Flush: Low Credenza: 72.5h oa	48.6	2	DZMWF78 4260	DZMWF84 4427	DZMWF90 4594	DZMWF96 4759	DZMWF102 4928	DZMWF108 5094	DZMWF114 5260	DZMWF120 5427							
Flush: Credenza: 84.5h oa	54.6	3	DZMWG78 4508	DZMWG84 4690	DZMWG90 4874	DZMWG96 5055	DZMWG102 5239	DZMWG108 5420	DZMWG114 5602	DZMWG120 5786							
Flush: Low Credenza: 84.5h oa	60.6	3	DZMWH78 4755	DZMWH84 4953	DZMWH90 5152	DZMWH96 5350	DZMWH102 5549	DZMWH108 5748	DZMWH114 5946	DZMWH120 6146							
Floor: Overhead	54.5	3	DZMWJ78 4508	DZMWJ84 4690	DZMWJ90 4874	DZMWJ96 5055	DZMWJ102 5239	DZMWJ108 5420	DZMWJ114 5602	DZMWJ120 5786							
Floor: 60.5h oa	60	4	DZMWK78 4755	DZMWK84 4953	DZMWK90 5152	DZMWK96 5350	DZMWK102 5549	DZMWK108 5748	DZMWK114 5946	DZMWK120 6146							
Floor: 72.5h oa	72	4															
Floor: 84.5h oa	84	5															

! Notes:

- All panels are magnetic or tackable.
- Metal shelves have a weight limit of 40 lbs per linear foot with a .25 inch drop.
- Wood shelves have a weight limit of 40 lbs per linear foot.
- Metal and Wood shelves cannot be intermixed on a single panel.
- Fabric panels width will be determined by fabric direction.
- Fabric panels over 96 inches wide will be two piece.
- Wall panels taller than 48.6h will be done in multiple sections to fit direction and size of Fabric roll.
- Any Fabric wall panel wider than 96w will be split vertically in two pieces.
- 1.5-in metal edge on all panels; 2 sides when below a hutch, 3 sides when not located under a hutch.
- Metal edge finish is MRBAS; Metal Resin Brushed Aluminum with Steel Tint.
- Max size of glass panels is 96w x 48h in one piece; max width is 96w.
- Shelf depth is 12d on both wood and metal shelves.
- Metal shelves are standard MRBAS, Brushed Aluminum w/Steel Tint.
- Number of shelves is determined by panel size.
- Specify shelf location using chart at bottom of section.
- OcuWrite Back-Painted Glass color: O.BWT White.

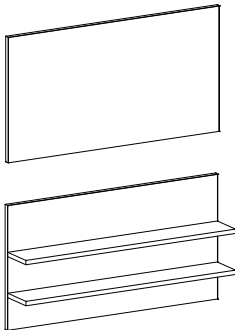

Grain Direction:
 Flat-cut veneers are applied vertically,
 quarter/rift-cut veneers horizontally.
 Other options on request.

Description	#Shelves	Product No.	List \$	Product No.	List \$	Product No.	List \$	Product No.	List \$	Product No.	List \$	Product No.	List \$	Product No.	List \$	Product No.	List \$
Wall Panels, OcuWrite BPGlass																	
	h	30w		36w		42w		48w		54w		60w		66w		72w	
Flush: Credenza: Hutch	25.1	1	DZMGA30 2856	DZMGA36 3053	DZMGA42 3254	DZMGA48 3452	DZMGA54 3650	DZMGA60 3849	DZMGA66 4047	DZMGA72 4247							
Flush: Low Credenza: Hutch	31.1	1	DZMGB30 3137	DZMGB36 3383	DZMGB42 3627	DZMGB48 3872	DZMGB54 4116	DZMGB60 4361	DZMGB66 4605	DZMGB72 4849							
Flush: Credenza: 60.5h oa	30.6	2	DZMGC30 3045	DZMGC36 3273	DZMGC42 3503	DZMGC48 3732	DZMGC54 3961	DZMGC60 4190	DZMGC66 4420	DZMGC72 4649							
Flush: Low Credenza: 60.5h oa	36.6	2	DZMGD30 3327	DZMGD36 3602	DZMGD42 3875	DZMGD48 4151	DZMGD54 4426	DZMGD60 4702	DZMGD66 4977	DZMGD72 5251							
Flush: Credenza: 72.5h oa	42.6	2	DZMGE30 3608	DZMGE36 3929	DZMGE42 4251	DZMGE48 4572	DZMGE54 4893	DZMGE60 5213	DZMGE66 5535	DZMGE72 5855							
Flush: Low Credenza: 72.5h oa	48.6	2	DZMGF30 3891	DZMGF36 4257	DZMGF42 4626	DZMGF48 4992	DZMGF54 5358	DZMGF60 5726	DZMGF66 6092	DZMGF72 6458							
Flush: Credenza: 84.5h oa	54.6	3	DZMGG30 4173	DZMGG36 4587	DZMGG42 4999	DZMGG48 5412	DZMGG54 5823	DZMGG60 6237	DZMGG66 6648	DZMGG72 7061							
Flush: Low Credenza: 84.5h oa	60.6	3	DZMGH30 4457	DZMGH36 4915	DZMGH42 5374	DZMGH48 5832	DZMGH54 6290	DZMGH60 6749	DZMGH66 7208	DZMGH72 7666							
Floor: Overhead	54.5	3	DZMGJ30 4173	DZMGJ36 4587	DZMGJ42 4999	DZMGJ48 5412	DZMGJ54 5823	DZMGJ60 6237	DZMGJ66 6648	DZMGJ72 7061							
Floor: 60.5h oa	60	4	DZMGK30 4457	DZMGK36 4915	DZMGK42 5374	DZMGK48 5832	DZMGK54 6290	DZMGK60 6749	DZMGK66 7208	DZMGK72 7666							
Floor: 72.5h oa	72	4	DZMGL30 5021	DZMGL36 5572	DZMGL42 6121	DZMGL48 6672	DZMGL54 7221	DZMGL60 7771									
Floor: 84.5h oa	84	5	DZMGM30 5588	DZMGM36 6227	DZMGM42 6869	DZMGM48 7512	DZMGM54 8153	DZMGM60 8795									
	h	78w		84w		90w		96w		102w		108w		114w		120w	
Flush: Credenza: Hutch	25.1	1	DZMGA78 4444	DZMGA84 4643	DZMGA90 4842	DZMGA96 5042											
Flush: Low Credenza: Hutch	31.1	1	DZMGB78 5094	DZMGB84 5339	DZMGB90 5583	DZMGB96 5827											
Flush: Credenza: 60.5h oa	30.6	2	DZMGC78 4879	DZMGC84 5107	DZMGC90 5336	DZMGC96 5566											
Flush: Low Credenza: 60.5h oa	36.6	2	DZMGD78 5527	DZMGD84 5802	DZMGD90 6078	DZMGD96 6351											
Flush: Credenza: 72.5h oa	42.6	2	DZMGE78 6176	DZMGE84 6497	DZMGE90 6817	DZMGE96 7139											
Flush: Low Credenza: 72.5h oa	48.6	2	DZMGF78 6827	DZMGF84 7193													
Flush: Credenza: 84.5h oa	54.6	3	DZMGG78 7475	DZMGG84 7886													
Flush: Low Credenza: 84.5h oa	60.6	3	DZMGH78 8124	DZMGH84 8583													
Floor: Overhead	54.5	3	DZMGJ78 7475	DZMGJ84 7886													
Floor: 60.5h oa	60	4	DZMGK78 8124	DZMGK84 8583													
Floor: 72.5h oa	72	4															
Floor: 84.5h oa	84	5															

! Notes:

- All panels are magnetic or tackable.
- Metal shelves have a weight limit of 40 lbs per linear foot with a .25 inch drop.
- Wood shelves have a weight limit of 40 lbs per linear foot.
- Metal and Wood cannot be intermixed on a single panel.
- Fabric panels width will be determined by fabric direction.
- Fabric panels over 96 inches wide will be two piece.
- Wall panels taller than 48.6h will be done in multiple sections to fit direction and size of Fabric roll.
- Any Fabric wall panel wider than 96w will be split vertically in two pieces.
- 1.5-in metal edge on all panels; 2 sides when below a hutch, 3 sides when not located under a hutch.
- Metal edge finish is MRBAS; Metal Resin Brushed Aluminum with Steel Tint.
- Max size of glass panels is 96w x 48h in one piece; max width is 96w.
- Shelf depth is 12d on both wood and metal shelves.
- Metal shelves are standard MRBAS, Brushed Aluminum w/Steel Tint.
- Number of shelves is determined by panel size.
- Specify shelf location using chart at bottom of section.
- OcuWrite Back-Painted Glass color: O.BWT White.

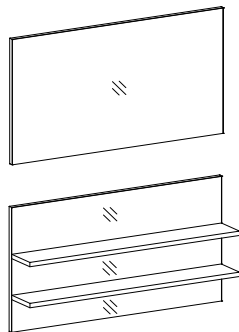

Grain Direction:
 Flat-cut veneers are applied vertically,
 quarter/rift-cut veneers horizontally.
 Other options on request.

Description	#Shelves	Product No.	List \$	Product No.	List \$	Product No.	List \$	Product No.	List \$	Product No.	List \$	Product No.	List \$	Product No.	List \$	Product No.	List \$	
Wall Panels, Fabric																		
	h	30w		36w		42w		48w		54w		60w		66w		72w		
Flush: Credenza: Hutch	25.1	1	DZMFA30	2121	DZMFA36	2138	DZMFA42	2154	DZMFA48	2171	DZMFA54	2186	DZMFA60	2202	DZMFA66	2219	DZMFA72	2235
Flush: Low Credenza: Hutch	31.1	1	DZMFB30	2194	DZMFB36	2214	DZMFB42	2233	DZMFB48	2253	DZMFB54	2275	DZMFB60	2296	DZMFB66	2315	DZMFB72	2336
Flush: Credenza: 60.5h oa	30.6	2	DZMFC30	2168	DZMFC36	2189	DZMFC42	2207	DZMFC48	2226	DZMFC54	2246	DZMFC60	2265	DZMFC66	2284	DZMFC72	2302
Flush: Low Credenza: 60.5h oa	36.6	2	DZMFD30	2242	DZMFD36	2265	DZMFD42	2286	DZMFD48	2310	DZMFD54	2334	DZMFD60	2355	DZMFD66	2380	DZMFD72	2403
Flush: Credenza: 72.5h oa	42.6	2	DZMFE30	2314	DZMFE36	2340	DZMFE42	2368	DZMFE48	2393	DZMFE54	2420	DZMFE60	2447	DZMFE66	2473	DZMFE72	2500
Flush: Low Credenza: 72.5h oa	48.6	2	DZMFF30	2386	DZMFF36	2417	DZMFF42	2447	DZMFF48	2477	DZMFF54	2507	DZMFF60	2538	DZMFF66	2569	DZMFF72	2600
Flush: Credenza: 84.5h oa	54.6	3	DZMFG30	2459	DZMFG36	2493	DZMFG42	2527	DZMFG48	2561	DZMFG54	2596	DZMFG60	2630	DZMFG66	2664	DZMFG72	2698
Flush: Low Credenza: 84.5h oa	60.6	3	DZMFH30	2530	DZMFH36	2568	DZMFH42	2607	DZMFH48	2645	DZMFH54	2684	DZMFH60	2721	DZMFH66	2759	DZMFH72	2798
Floor: Overhead	54.5	3	DZMFJ30	2459	DZMFJ36	2493	DZMFJ42	2527	DZMFJ48	2561	DZMFJ54	2596	DZMFJ60	2630	DZMFJ66	2664	DZMFJ72	2698
Floor: 60.5h oa	60	4	DZMFK30	2530	DZMFK36	2568	DZMFK42	2607	DZMFK48	2645	DZMFK54	—	—	—	—	—	—	—
Floor: 72.5h oa	72	4	DZMFL30	2674	DZMFL36	2720	DZMFL42	2768	DZMFL48	2811	DZMFL54	—	—	—	—	—	—	—
Floor: 84.5h oa	84	5	DZMFM30	2820	DZMFM36	2873	DZMFM42	2927	DZMFM48	2980	DZMFM54	—	—	—	—	—	—	—
	h	78w		84w		90w		96w		102w		108w		114w		120w		
Flush: Credenza: Hutch	25.1	1	DZMFA78	2252	DZMFA84	2269	DZMFA90	2286	DZMFA96	2303	DZMFA102	2320	DZMFA108	2336	DZMFA114	2353	DZMFA120	2369
Flush: Low Credenza: Hutch	31.1	1	DZMFB78	2355	DZMFB84	2376	DZMFB90	2396	DZMFB96	2417	DZMFB102	2438	DZMFB108	2458	DZMFB114	2477	DZMFB120	2498
Flush: Credenza: 60.5h oa	30.6	2	DZMFC78	2321	DZMFC84	2340	DZMFC90	2359	DZMFC96	2380	DZMFC102	2398	DZMFC108	2417	DZMFC114	2437	DZMFC120	2455
Flush: Low Credenza: 60.5h oa	36.6	2	DZMFD78	2423	DZMFD84	2447	DZMFD90	2471	DZMFD96	2493	DZMFD102	2516	DZMFD108	2540	DZMFD114	2561	DZMFD120	2584
Flush: Credenza: 72.5h oa	42.6	2	DZMFE78	2527	DZMFE84	2555	DZMFE90	2580	DZMFE96	2608	DZMFE102	2634	DZMFE108	2661	DZMFE114	2687	DZMFE120	2714
Flush: Low Credenza: 72.5h oa	48.6	2	DZMFF78	2630	DZMFF84	2661	DZMFF90	2691	DZMFF96	2721	DZMFF102	2752	DZMFF108	2782	DZMFF114	2811	DZMFF120	2844
Flush: Credenza: 84.5h oa	54.6	3	DZMFG78	2734	DZMFG84	2768	DZMFG90	2802	DZMFG96	2836	DZMFG102	2871	DZMFG108	2905	DZMFG114	2939	DZMFG120	2973
Flush: Low Credenza: 84.5h oa	60.6	3	DZMFH78	2836	DZMFH84	2875	DZMFH90	2911	DZMFH96	2949	DZMFH102	2988	DZMFH108	3027	DZMFH114	3066	DZMFH120	3102
Floor: Overhead	54.5	3	DZMFJ78	2734	DZMFJ84	2768	DZMFJ90	2802	DZMFJ96	2836	DZMFJ102	2871	DZMFJ108	2905	DZMFJ114	2939	DZMFJ120	2973
Floor: 60.5h oa	60	4	—	—	—	—	—	—	—	—	—	—	—	—	—	—	—	—
Floor: 72.5h oa	72	4	—	—	—	—	—	—	—	—	—	—	—	—	—	—	—	—
Floor: 84.5h oa	84	5	—	—	—	—	—	—	—	—	—	—	—	—	—	—	—	—

COM Fabric Requirements (yards of 54w material)

	30w	36w	48w	54w	60w	66w	72w	78w	84w	90w	96w	102w	108w	114w	120w
25.1	1.0	1.2	1.5	1.7	1.9	2.2	2.2	2.4	2.5	2.7	2.9	3.2	3.4	3.5	3.7
31.1	1.0	1.2	1.5	1.7	1.9	2.2	2.2	2.4	2.5	2.7	2.9	3.2	3.4	3.5	3.7
30.6	2.0	2.4	3.0	3.4	3.8	4.4	4.4	4.8	5.0	5.4	5.8	6.4	6.8	7.0	7.4
36.6	2.0	2.4	3.0	3.4	3.8	4.4	4.4	4.8	5.0	5.4	5.8	6.4	6.8	7.0	7.4
42.6	2.0	2.4	3.0	3.4	3.8	4.4	4.4	4.8	5.0	5.4	5.8	6.4	6.8	7.0	7.4
48.6	2.0	2.4	3.0	3.4	3.8	4.4	4.4	4.8	5.0	5.4	5.8	6.4	6.8	7.0	7.4
54.6	2.0	2.4	3.0	3.4	3.8	4.4	4.4	4.8	5.0	5.4	5.8	6.4	6.8	7.0	7.4
60.6	2.0	2.4	3.0	3.4	3.8	4.4	4.4	4.8	5.0	5.4	5.8	6.4	6.8	7.0	7.4
54.5	2.0	2.4	3.0	3.4	3.8	4.4	4.4	4.8	5.0	5.4	5.8	6.4	6.8	7.0	7.4
60	2.0	2.4	3.0	3.4	3.8	4.4	4.4	4.8	5.0	5.4	5.8	6.4	6.8	7.0	7.4
72	3.0	3.6	4.5	5.1	5.7	6.6	6.6	7.2	7.5	8.1	8.7	9.6	10.2	10.5	11.1
84	3.0	3.6	4.5	5.1	5.7	6.6	6.6	7.2	7.5	8.1	8.7	9.6	10.2	10.5	11.1

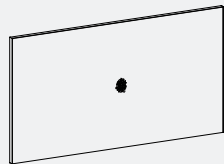

See Notes on the following page for specification information.

Grain Direction:
 Flat-cut veneers are applied vertically,
 quarter/rift-cut veneers horizontally.
 Other options on request.

Shelves

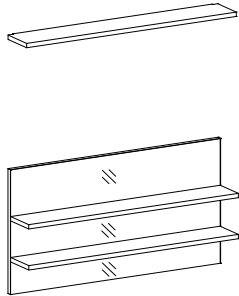

Description	Wood 1.5th		Metal 0.25th	
	Product No.	List \$	Product No.	List \$
Shelf 30w 12d	DZMSW30	1062	DZMSM30	1144
Shelf 36w 12d	DZMSW36	1099	DZMSM36	1220
Shelf 48w 12d	DZMSW48	1249	DZMSM48	1322
Shelf 54w 12d	DZMSW54	1287	DZMSM54	1322
Shelf 60w 12d	DZMSW60	1396	DZMSM60	1322
Shelf 66w 12d	DZMSW66	1434	DZMSM66	1398
Shelf 72w 12d	DZMSW72	1471	DZMSM72	1398
Shelf 78w 12d	DZMSW78	1582	DZMSM78	1398
Shelf 84w 12d	DZMSW84	1621	DZMSM84	1475
Shelf 90w 12d	DZMSW90	1659	DZMSM90	1475
Shelf 96w 12d	DZMSW96	1768	DZMSM96	1704
Shelf 102w 12d	DZMSW102	1807	DZMSM102	1704
Shelf 108w 12d	DZMSW108	1845	DZMSM108	1704
Shelf 114w 12d	DZMSW114	1954	DZMSM114	1755
Shelf 120w 12d	DZMSW120	1994	DZMSM120	1755

! Notes—for Wall Panels and Shelves:

All panels are magnetic or tackable.

Metal shelves have a weight limit of 40 lbs per linear foot with a .25 inch drop.

Wood shelves have a weight limit of 40 lbs per linear foot.

Metal and Wood cannot be intermixed on a single panel.

Fabric panels width will be determined by fabric direction.

Fabric panels over 96 inches wide will be two piece.

Wall panels taller than 48.6h will be done in multiple sections to fit direction and size of Fabric roll.

Any Fabric wall panel wider than 96w will be split vertically in two pieces.

1.5-in metal edge on all panels; 2 sides when below a hutch, 3 sides when not located under a hutch.

Metal edge finish is MRBAS; Metal Resin Brushed Aluminum with Steel Tint.

Max size of glass panels is 96w x 48h in one piece; max width is 96w.

Shelf depth is 12d on both wood and metal shelves.

Metal shelves are standard MRBAS, Brushed Aluminum w/Steel Tint.

Number of shelves is determined by panel size.

Specify shelf location using chart at bottom of section.

OcuWrite Back-Painted Glass color: O.BWT White.

Towers Lateral Files

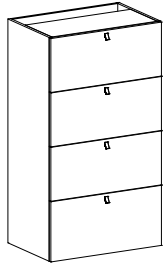

Description	20d		24d			
	Product No.	List \$	Product No.	List \$		
Tower	DZTLA	sum	DZTLB	sum		
Tower with Toe Kick	DZTLATK	sum	DZTLBTK	sum		
	Spec Code	▲	Spec Code	▲	Spec Code	Add \$
	Wood1 Faces		Wood1 Faces		Acrylic Faces	
LatFile 3-High 24w 41.5h	3H24	2980	3H24	3232	A	1021
LatFile 3-High 30w 41.5h	3H30	3173	3H30	3430	A	1021
LatFile 3-High 36w 41.5h	3H36	3297	3H36	3556	A	1021
LatFile 4-High 24w 54.75h	4H24	3413	4H24	3745	A	1021
LatFile 4-High 30w 54.75h	4H30	3669	4H30	4007	A	1021
LatFile 4-High 36w 54.75h	4H36	3828	4H36	4167	A	1021

! Notes:

File towers must be anchored to wall or back to back.

Tower tops are unfinished, top must be purchased from top chart above.

Pull finish is standard MRBAS, Brushed Aluminum w/Steel tint; for polished specify MPA, Polished Aluminum.

For Drawer locks, specify LG; add \$250.

Acrylic faces are Stylelite Arctic White standard.

Towers 60.5h

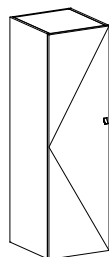
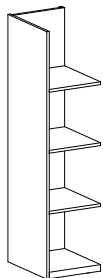
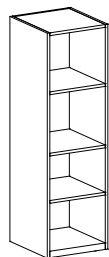

Description	Product No. List \$		Product No. List \$					
	20d		24d					
Tower 60.5	DZT60A	sum	DZT60B	sum				
Tower 60.5 with Toe Kick	DZT60ATK	sum	DZT60BTK	sum				
	Spec Code	▲	Spec Code	▲	Spec Code	Add \$	Spec Code	Add \$
	Wood1 Faces		Wood1 Faces		Acrylic Faces		Mirror	
Shelving 16w	A16	2603	A16	2946	—	—	—	—
• Shelving 18w	A18	2670	A18	3029	—	—	—	—
Shelving 20w	A20	2772	A20	3149	—	—	—	—
Shelving 24w	A24	2890	A24	3300	—	—	—	—
Shelving 30w	A30	3109	A30	3571	—	—	—	—
Shelving 36w	A36	3329	A36	3844	—	—	—	—
Corner Shelving 16w LH	BL16	2297	BL16	2534	—	—	—	—
Corner Shelving 16w RH	BR16	2297	BR16	2534	—	—	—	—
Corner Shelving 18w LH	BL18	2363	BL18	2618	—	—	—	—
Corner Shelving 18w RH	BR18	2363	BR18	2618	—	—	—	—
Corner Shelving 20w LH	BL20	2465	BL20	2738	—	—	—	—
• Corner Shelving 20w RH	BR20	2465	BR20	2738	—	—	—	—
Cabinet 16w LH	CL16	2836	CL16	3177	A	1046	—	—
Cabinet 16w RH	CR16	2836	CR16	3177	A	1046	—	—
• Cabinet 18w LH	CL18	2955	CL18	3314	A	1046	—	—
Cabinet 18w RH	CR18	2955	CR18	3314	A	1046	—	—
Cabinet 20w LH	CL20	3106	CL20	3484	A	1046	—	—
Cabinet 20w RH	CR20	3106	CR20	3484	A	1046	—	—
Cabinet 24w LH	CL24	3321	CL24	3731				
Cabinet 24w RH	CR24	3321	CR24	3731	A	1046	—	—
Cabinet 30w DBL	C30	3489	C30	3900	A	1046	—	—
Cabinet 36w DBL	C36	3658	C36	4068	A	1046	—	—

(listing continued on following page)

! Notes:

- All units have unfinished backs.
- LH and RH designations indicate hinge side on the single door units.
- 60.5 units have finished tops, all other heights have unfinished tops.
- Corner shelving units must be secured to wall with cleat provided, or to adjoining units (i.e., pedestals or towers).
- For units with toe kick use prefix with toe kick.
- Toe kick finish is standard MRBAS, Brushed Aluminum w/Steel Tint; for polished specify MPA, Polished Aluminum.
- Pull finish is standard MRBAS, Brushed Aluminum w/Steel tint; for polished specify MPA, Polished Aluminum.
- Acrylic faces are Stylelite Arctic White standard.

Towers 60.5h (continued)

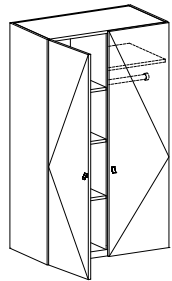
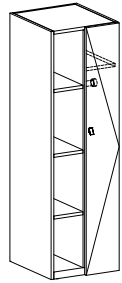

Description	Product No. List \$		Product No. List \$					
	20d		24d					
	Spec Code		Spec Code		Spec Code	Add \$	Spec Code	Add \$
	Wood1 Faces		Wood1 Faces		Acrylic Faces		Mirror	
Grmt8:Shv8 16w LH	DL16	3040	DL16	3486	A	1046	MR	—
Shv8:Grmt8 16w RH	DR16	3040	DR16	3486	A	1046	MR	—
Grmt9:Shv9 18w LH	DL18	3128	DL18	3579	A	1046	MR	—
• Shv9:Grmt9 18w RH	DR18	3128	DR18	3579	A	1046	MR	—
Grmt10:Shv10 20w LH	DL20	3201	DL20	3658	A	1046	MR	—
Shv10:Grmt10 20w RH	DR20	3201	DR20	3658	A	1046	MR	—
Grmt12:Shv12 24w LH	DL24	3256	DL24	3728	A	1046	MR	—
Shv12:Grmt12 24w RH	DR24	3256	DR24	3728	A	1046	MR	—
Grmt15:Shv15 30w LH	DL30	3506	DL30	4006	A	1046	MR	153
Shv15:Grmt15 30w RH	DR30	3506	DR30	4006	A	1046	MR	153
Grmt18:Shv18 36w LH	DL36	3613	DL36	4126	A	1046	MR	248
Shv18:Grmt18 36w RH	DR36	3613	DR36	4126	A	1046	MR	248
Grmt8:Cab8 16w LH	EL16	3164	EL16	3588	A	1046	MR	125
Cab8:Grmt8 16w RH	ER16	3164	ER16	3588	A	1046	MR	125
Grmt9:Cab9 18w LH	EL18	3231	EL18	3682	A	1046	MR	140
Cab9:Grmt9 18w RH	ER18	3231	ER18	3682	A	1046	MR	140
Grmt10:Cab10 20w LH	EL20	3353	EL20	3709	A	1046	MR	156
Cab10:Grmt10 20w RH	ER20	3353	ER20	3709	A	1046	MR	156
Grmt12:Cab12 24w DBL	EA24	3506	EA24	3978	A	1046	MR	—
Cab12:Grmt12 24w DBL	EB24	3506	EB24	3978	A	1046	MR	—
Grmt15:Cab15 30w DBL	EA30	3674	EA30	4255	A	1046	MR	233
Cab15:Grmt15 30w DBL	EB30	3674	EB30	4255	A	1046	MR	233
Grmt18:Cab18 36w DBL	EA36	3841	EA36	4424	A	1046	MR	248
• Cab18:Grmt18 36w DBL	EB36	3841	EB36	4424	A	1046	MR	248

(listing continued on following page)

! Notes:

- All units have unfinished backs.
- LH and RH designations indicate hinge side on the single door units.
- 60.5 units have finished tops, all other heights have unfinished tops.
- Corner shelving units must be secured to wall with cleat provided, or to adjoining units (i.e., pedestals or towers).
- For units with toe kick use prefix with toe kick.
- Toe kick finish is standard MRBAS, Brushed Aluminum w/Steel Tint; for polished specify MPA, Polished Aluminum.
- Pull finish is standard MRBAS, Brushed Aluminum w/Steel tint; for polished specify MPA, Polished Aluminum.
- Acrylic faces are Stylelite Arctic White standard.

+ Options:

- To specify Acrylic faces add A to spec code and add \$ total amount.
- To specify mirror add MR to spec code and add \$ amount to total.
- For Door/Cabinet locks, specify LD; add \$210.
- For Drawer locks, specify LG add \$250.

Towers 60.5h (continued)

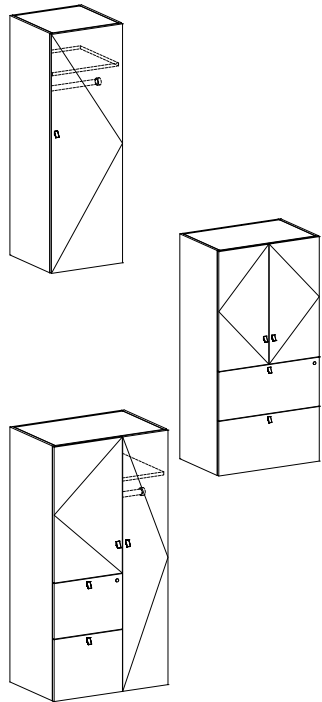

Description	Product No. List \$		Product No. List \$							
	20d		24d							
	Spec Code		Spec Code		Spec Code	Add \$	Spec Code	Add \$		
	Wood1 Faces		Wood1 Faces		Acrylic Faces		Mirror			
Garment 16w LH	GL16	2670	GL16	2960	A	1046	MR	125		
Garment 16w RH	GR16	2670	GR16	2960	A	1046	MR	125		
Garment 18w LH	GL18	2769	GL18	3067	A	1046	MR	140		
Garment 18w RH	GR18	2769	GR18	3067	A	1046	MR	140		
Garment 20w LH	GL20	2903	GL20	3209	A	1046	MR	156		
• Garment 20w RH	GR20	2903	GR20	3209	A	1046	MR	156		
Garment 24w LH	GL24	3069	GL24	3378	A	1046	MR	187		
Garment 24w RH	GR24	3069	GR24	3378	A	1046	MR	187		
Cab2:2File 16w LH	HL16	3453	HL16	3846	A	1046	MR	—		
Cab2:2File 16w RH	HR16	3453	HR16	3846	A	1046	MR	—		
Cab2:2File 18w LH	HL18	3551	HL18	3924	A	1046	MR	—		
Cab2:2File 18w RH	HR18	3551	HR18	3924	A	1046	MR	—		
Cab2:2File 20w LH	HL20	3706	HL20	4120	A	1046	MR	—		
Cab2:2File 20w RH	HR20	3706	HR20	4120	A	1046	MR	—		
Cab2:2File 24w DBL	H24	3891	H24	4330	A	1046	MR	—		
• Cab2:2File 30w DBL	H30	4130	H30	4573	A	1046	MR	—		
Cab2:2File 36w DBL	H36	4335	H36	4778	A	1046	MR	—		
Cab2/2File 16:Grmt8 24w DBL	JA24	4164	JA24	4701	A	1046	MR	—		
Grmt8:Cab2/2File 16 24w DBL	JB24	4164	JB24	4701	A	1046	MR	—		
Cab2/2File 18:Grmt12 30w DBL	JA30	4334	JA30	4894	A	1046	MR	233		
Grmt12:Cab2/2File 18 30w DBL	JB30	4334	JB30	4894	A	1046	MR	233		
• Cab2/2File 18:Grmt18 36w DBL	JA36	4502	JA36	5062	A	1046	MR	248		
Grmt18:Cab2/2File 18 36w DBL	JB36	4502	JB36	5062	A	1046	MR	248		

! Notes:

- All units have unfinished backs.
- LH and RH designations indicate hinge side on the single door units.
- 60.5 units have finished tops, all other heights have unfinished tops.
- Corner shelving units must be secured to wall with cleat provided, or to adjoining units (i.e., pedestals or towers).
- For units with toe kick use prefix with toe kick.
- Toe kick finish is standard MRBAS, Brushed Aluminum w/Steel Tint; for polished specify MPA, Polished Aluminum.
- Pull finish is standard MRBAS, Brushed Aluminum w/Steel tint; for polished specify MPA, Polished Aluminum.
- Acrylic faces are Stylelite Arctic White standard.

+ Options:

- To specify Acrylic faces add A to spec code and add \$ total amount.
- To specify mirror add MR to spec code and add \$ amount to total.
- For Door/Cabinet locks, specify LD; add \$210.
- For Drawer locks, specify LG add \$250.

Towers 72.5h

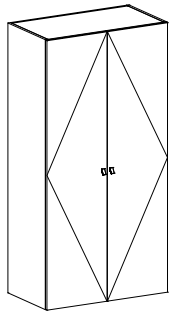
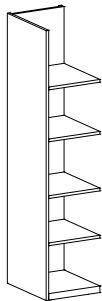
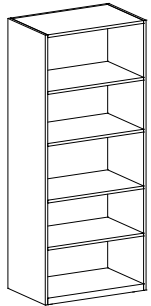

Description	Product No. List \$		Product No. List \$					
	20d		24d					
Tower 72.5	DZT72A	sum	DZT72B	sum				
Tower 72.5 with Toe Kick	DZT72ATK	sum	DZT72BTK	sum				
	Spec Code	▲	Spec Code	▲	Spec Code	Add \$	Spec Code	Add \$
	Wood1 Faces		Wood1 Faces		Acrylic Faces		Mirror	
Shelving 16w	A16	2949	A16	3360	—	—	—	—
Shelving 18w	A18	3039	A18	3470	—	—	—	—
Shelving 20w	A20	3152	A20	3603	—	—	—	—
Shelving 24w	A24	3301	A24	3796	—	—	—	—
• Shelving 30w	A30	3568	A30	4121	—	—	—	—
Shelving 36w	A36	3832	A36	4447	—	—	—	—
Corner Shelving 16w LH	BL16	2498	BL16	2757	—	—	—	—
• Corner Shelving 16w RH	BR16	2498	BR16	2757	—	—	—	—
Corner Shelving 18w LH	BL18	2578	BL18	2855	—	—	—	—
Corner Shelving 18w RH	BR18	2578	BR18	2855	—	—	—	—
Corner Shelving 20w LH	BL20	2680	BL20	2974	—	—	—	—
Corner Shelving 20w RH	BR20	2680	BR20	2974	—	—	—	—
Cabinet 16w LH	CL16	3159	CL16	3542	A	1046	—	—
Cabinet 16w RH	CR16	3159	CR16	3542	A	1046	—	—
Cabinet 18w LH	CL18	3311	CL18	3711	A	1046	—	—
Cabinet 18w RH	CR18	3311	CR18	3711	A	1046	—	—
Cabinet 20w LH	CL20	3464	CL20	3881	A	1046	—	—
Cabinet 20w RH	CR20	3464	CR20	3881	A	1046	—	—
Cabinet 24w LH	CL24	3723	CL24	4173	A	1046	—	—
Cabinet 24w RH	CR24	3723	CR24	4173	A	1046	—	—
• Cabinet 30w DBL	C30	3924	C30	4376	A	1046	—	—
Cabinet 36w DBL	C36	4127	C36	4579	A	1046	—	—

(listing continued on following page)

! Notes:

- All units have unfinished backs.
- LH and RH designations indicate hinge side on the single door units.
- 72.5h units have unfinished tops.
- Corner shelving units must be secured to wall with cleat provided, or to adjoining units (i.e., pedestals or towers).
- For units with toe kick use prefix with toe kick.
- Toe kick finish is standard MRBAS, Brushed Aluminum w/Steel Tint; for polished specify MPA, Polished Aluminum.
- Pull finish is standard MRBAS, Brushed Aluminum w/Steel tint; for polished specify MPA, Polished Aluminum.
- Acrylic faces are Stylelite Arctic White standard.

+ Options:

- To specify Acrylic faces add A to spec code and add \$ total amount.
- To specify mirror add MR to spec code and add \$ amount to total.
- For Door/Cabinet locks, specify LD; add \$210.
- For Drawer locks, specify LG add \$250.

Towers 72.5h (continued)

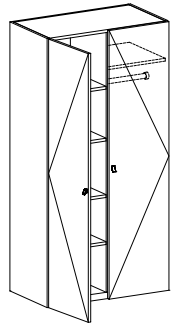
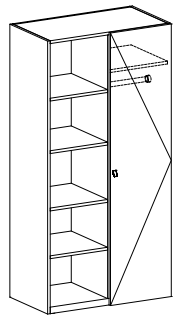

Description	Product No. List \$		Product No. List \$					
	20d		24d					
	Spec Code	▲	Spec Code	▲	Spec Code	Add \$	Spec Code	Add \$
	Wood1	Faces	Wood1	Faces	Acrylic	Faces	Mirror	
Grmt8:Shv8 16w LH	DL16	3467	DL16	3995	A	1046	MR	—
Shv8:Grmt8 16w RH	DR16	3467	DR16	3995	A	1046	MR	—
Grmt9:Shv9 18w LH	DL18	3588	DL18	4121	A	1046	MR	—
Shv9:Grmt9 18w RH	DR18	3588	DR18	4121	A	1046	MR	—
Grmt10:Shv10 20w LH	DL20	3659	DL20	4200	A	1046	MR	—
Shv10:Grmt10 20w RH	DR20	3659	DR20	4200	A	1046	MR	—
Grmt12:Shv12 24w LH	DL24	3729	DL24	4284	A	1046	MR	—
• Shv12:Grmt12 24w RH	DR24	3729	DR24	4284	A	1046	MR	—
Grmt15:Shv15 30w LH	DL30	4033	DL30	4622	A	1046	MR	276
Shv15:Grmt15 30w RH	DR30	4033	DR30	4622	A	1046	MR	276
Grmt18:Shv18 36w LH	DL36	4164	DL36	4770	A	1046	MR	294
Shv18:Grmt18 36w RH	DR36	4164	DR36	4770	A	1046	MR	294
Grmt8:Cab8 16w LH	EL16	3612	EL16	4117	A	1046	MR	146
Cab8:Grmt8 16w RH	ER16	3612	ER16	4117	A	1046	MR	146
Grmt9:Cab9 18w LH	EL18	3711	EL18	4246	A	1046	MR	164
Cab9:Grmt9 18w RH	ER18	3711	ER18	4246	A	1046	MR	164
Grmt10:Cab10 20w LH	EL20	3834	EL20	4374	A	1046	MR	185
Cab10:Grmt10 20w RH	ER20	3834	ER20	4374	A	1046	MR	185
Grmt12:Cab12 24w DBL	EA24	4031	EA24	4586	A	1046	MR	—
Cab12:Grmt12 24w DBL	EB24	4031	EB24	4586	A	1046	MR	—
Grmt15:Cab15 30w DBL	EA30	4233	EA30	4925	A	1046	MR	276
Cab15:Grmt15 30w DBL	EB30	4233	EB30	4925	A	1046	MR	276
Grmt18:Cab18 36w DBL	EA36	4435	EA36	5127	A	1046	MR	294
• Cab18:Grmt18 36w DBL	EB36	4435	EB36	5127	A	1046	MR	294

(listing continued on following page)

! Notes:

- All units have unfinished backs.
- LH and RH designations indicate hinge side on the single door units.
- 72.5h units have unfinished tops.
- For units with toe kick use prefix with toe kick.
- Toe kick finish is standard MRBAS, Brushed Aluminum w/Steel Tint; for polished specify MPA, Polished Aluminum.
- Pull finish is standard MRBAS, Brushed Aluminum w/Steel tint; for polished specify MPA, Polished Aluminum.
- Acrylic faces are Stylelite Arctic White standard.

+Options:

- To specify Acrylic faces add A to spec code and add \$ total amount.
- To specify mirror add MR to spec code and add \$ amount to total.
- For Door/Cabinet locks, specify LD; add \$210.
- For Drawer locks, specify LG add \$250.

Towers 72.5h (continued)

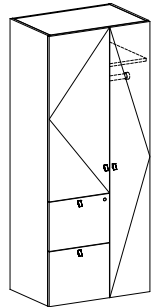
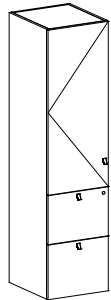
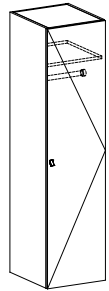

Description	Product No. List \$		Product No. List \$		Spec Code Add \$		Spec Code Add \$		
	20d		24d		Acrylic Faces		Mirror		
	Spec Code		Spec Code		Spec Code	Add \$	Spec Code	Add \$	
	Wood1	Faces	Wood1	Faces	Acrylic		Mirror		
Garment 16w LH	GL16	2995	GL16	3323	A	1046	MR	146	
Garment 16w RH	GR16	2995	GR16	3323	A	1046	MR	146	
Garment 18w LH	GL18	3126	GL18	3464	A	1046	MR	164	
• Garment 18w RH	GR18	3126	GR18	3464	A	1046	MR	164	
Garment 20w LH	GL20	3259	GL20	3607	A	1046	MR	185	
Garment 20w RH	GR20	3259	GR20	3607	A	1046	MR	185	
Garment 24w LH	GL24	3461	GL24	3811	A	1046	MR	220	
Garment 24w RH	GR24	3461	GR24	3811	A	1046	MR	220	
Cab3:2File 16w LH	HL16	3807	HL16	4282	A	1046	MR	—	
Cab3:2File 16w RH	HR16	3807	HR16	4282	A	1046	MR	—	
• Cab3:2File 18w LH	HL18	3951	HL18	4407	A	1046	MR	—	
Cab3:2File 18w RH	HR18	3951	HR18	4407	A	1046	MR	—	
Cab3:2File 20w LH	HL20	4114	HL20	4616	A	1046	MR	—	
Cab3:2File 20w RH	HR20	4114	HR20	4616	A	1046	MR	—	
Cab3:2File 24w DBL	H24	4376	H24	4897	A	1046	MR	—	
Cab3:2File 30w DBL	H30	4649	H30	5175	A	1046	MR	—	
Cab3:2File 36w DBL	H36	4887	H36	5414	A	1046	MR	—	
Cab3/2File 16:Grmt8 24w DBL	JA24	4649	JA24	5268	A	1046	MR	—	
Grmt8:Cab3/2File 16 24w DBL	JB24	4649	JB24	5268	A	1046	MR	—	
Cab3/2File 18:Grmt12 30w DBL	JA30	4852	JA30	5523	A	1046	MR	276	
Grmt12:Cab3/2File 18 30w DBL	JB30	4852	JB30	5523	A	1046	MR	276	
• Cab3/2File 18:Grmt18 36w DBL	JA36	5054	JA36	5726	A	1046	MR	294	
Grmt18:Cab3/2File 18 36w DBL	JB36	5054	JB36	5726	A	1046	MR	294	

! Notes:

- All units have unfinished backs.
- LH and RH designations indicate hinge side on the single door units.
- 72.5h units have unfinished tops.
- For units with toe kick use prefix with toe kick.
- Toe kick finish is standard MRBAS, Brushed Aluminum w/Steel Tint; for polished specify MPA, Polished Aluminum.
- Pull finish is standard MRBAS, Brushed Aluminum w/Steel tint; for polished specify MPA, Polished Aluminum.
- Acrylic faces are Stylelite Arctic White standard.

+ Options:

- To specify Acrylic faces add A to spec code and add \$ total amount.
- To specify mirror add MR to spec code and add \$ amount to total.
- For Door/Cabinet locks, specify LD; add \$210.
- For Drawer locks, specify LG add \$250.

Towers 84.5h

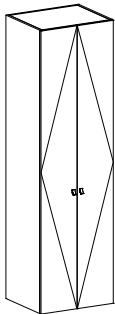
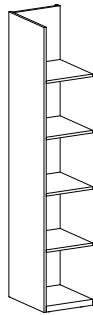
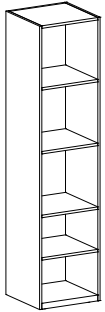

Description	Product No. List \$		Product No. List \$					
	20d		24d					
Tower 84.5	DZT84A	sum	DZT84B	sum				
Tower 84.5 with Toe Kick	DZT84ATK	sum	DZT84BTK	sum				
	Spec Code		Spec Code		Spec Code	Add \$	Spec Code	Add \$
	Wood1 Faces		Wood1 Faces		Acrylic Faces		Mirror	
Shelving 16w	A16	3413	A16	3866	—	—	—	—
Shelving 18w	A18	3517	A18	3988	—	—	—	—
• Shelving 20w	A20	3627	A20	4121	—	—	—	—
Shelving 24w	A24	3793	A24	4327	—	—	—	—
Shelving 30w	A30	4069	A30	4666	—	—	—	—
Shelving 36w	A36	4346	A36	5003	—	—	—	—
Corner Shelving 16w LH	BL16	2900	BL16	3180	—	—	—	—
• Corner Shelving 16w RH	BR16	2900	BR16	3180	—	—	—	—
Corner Shelving 18w LH	BL18	2993	BL18	3290	—	—	—	—
Corner Shelving 18w RH	BR18	2993	BR18	3290	—	—	—	—
Corner Shelving 20w LH	BL20	3095	BL20	3410	—	—	—	—
Corner Shelving 20w RH	BR20	3095	BR20	3410	—	—	—	—
Cabinet 16w LH	CL16	3524	CL16	3950	A	1046	—	—
Cabinet 16w RH	CR16	3524	CR16	3950	A	1046	—	—
Cabinet 18w LH	CL18	3710	CL18	4151	A	1046	—	—
Cabinet 18w RH	CR18	3710	CR18	4151	A	1046	—	—
Cabinet 20w LH	CL20	3863	CL20	4322	A	1046	—	—
Cabinet 20w RH	CR20	3863	CR20	4322	A	1046	—	—
Cabinet 24w LH	CL24	4154	CL24	4649	A	1046	—	—
Cabinet 24w RH	CR24	4154	CR24	4649	A	1046	—	—
• Cabinet 30w DBL	C30	4391	C30	4883	A	1046	—	—
Cabinet 36w DBL	C36	4628	C36	5121	A	1046	—	—

! Notes:

- All units have unfinished backs.
- LH and RH designations indicate hinge side on the single door units.
- 84.5h units have unfinished tops.
- Corner shelving units must be secured to wall with cleat provided, or to adjoining units (i.e., pedestals or towers).
- For units with toe kick use prefix with toe kick.
- Toe kick finish is standard MRBAS, Brushed Aluminum w/Steel Tint; for polished specify MPA, Polished Aluminum.
- Pull finish is standard MRBAS, Brushed Aluminum w/Steel tint; for polished specify MPA, Polished Aluminum.
- Acrylic faces are Stylelite Arctic White standard.

+ Options:

- To specify Acrylic faces add A to spec code and add \$ total amount.
- To specify mirror add MR to spec code and add \$ amount to total.
- For Door/Cabinet locks, specify LD; add \$210.
- For Drawer locks, specify LG add \$250.

Towers 84.5h (continued)

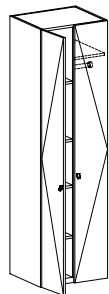
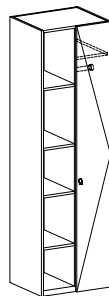

Description	Product No. List \$		Product No. List \$					
	20d		24d					
	Spec Code	▲	Spec Code	▲	Spec Code	Add \$	Spec Code	Add \$
	Wood1 Faces		Wood1 Faces		Acrylic Faces		Mirror	
Grmt8:Shv8 16w LH	DL16	3873	DL16	4463	A	1046	MR	—
Shv8:Grmt8 16w RH	DR16	3873	DR16	4463	A	1046	MR	—
Grmt9:Shv9 18w LH	DL18	4029	DL18	4623	A	1046	MR	—
Shv9:Grmt9 18w RH	DR18	4029	DR18	4623	A	1046	MR	—
Grmt10:Shv10 20w LH	DL20	4099	DL20	4702	A	1046	MR	—
Shv10:Grmt10 20w RH	DR20	4099	DR20	4702	A	1046	MR	—
Grmt12:Shv12 24w LH	DL24	4182	DL24	4798	A	1046	MR	—
• Shv12:Grmt12 24w RH	DR24	4182	DR24	4798	A	1046	MR	—
Grmt15:Shv15 30w LH	DL30	4520	DL30	5170	A	1046	MR	317
Shv15:Grmt15 30w RH	DR30	4520	DR30	5170	A	1046	MR	317
Grmt18:Shv18 36w LH	DL36	4665	DL36	5331	A	1046	MR	338
Shv18:Grmt18 36w RH	DR36	4665	DR36	5331	A	1046	MR	338
Grmt8:Cab8 16w LH	EL16	4038	EL16	4606	A	1046	MR	169
Cab8:Grmt8 16w RH	ER16	4038	ER16	4606	A	1046	MR	169
Grmt9:Cab9 18w LH	EL18	4172	EL18	4769	A	1046	MR	191
Cab9:Grmt9 18w RH	ER18	4172	ER18	4769	A	1046	MR	191
Grmt10:Cab10 20w LH	EL20	4294	EL20	4897	A	1046	MR	212
Cab10:Grmt10 20w RH	ER20	4294	ER20	4897	A	1046	MR	212
• Grmt12:Cab12 24w DBL	EA24	4526	EA24	5141	A	1046	MR	—
Cab12:Grmt12 24w DBL	EB24	4526	EB24	5141	A	1046	MR	—
Grmt15:Cab15 30w DBL	EA30	4761	EA30	5513	A	1046	MR	317
Cab15:Grmt15 30w DBL	EB30	4761	EB30	5513	A	1046	MR	317
Grmt18:Cab18 36w DBL	EA36	4997	EA36	5749	A	1046	MR	338
Cab18:Grmt18 36w DBL	EB36	4997	EB36	5749	A	1046	MR	338

(listing continued on following page)

! Notes:

- All units have unfinished backs.
- LH and RH designations indicate hinge side on the single door units.
- 84.5h units have unfinished tops.
- For units with toe kick use prefix with toe kick.
- Toe kick finish is standard MRBAS, Brushed Aluminum w/Steel Tint; for polished specify MPA, Polished Aluminum.
- Pull finish is standard MRBAS, Brushed Aluminum w/Steel tint; for polished specify MPA, Polished Aluminum.
- Acrylic faces are Stylelite Arctic White standard.

+Options:

- To specify Acrylic faces add A to spec code and add \$ total amount.
- To specify mirror add MR to spec code and add \$ amount to total.
- For Door/Cabinet locks, specify LD; add \$210.
- For Drawer locks, specify LG add \$250.

Towers 84.5h (continued)

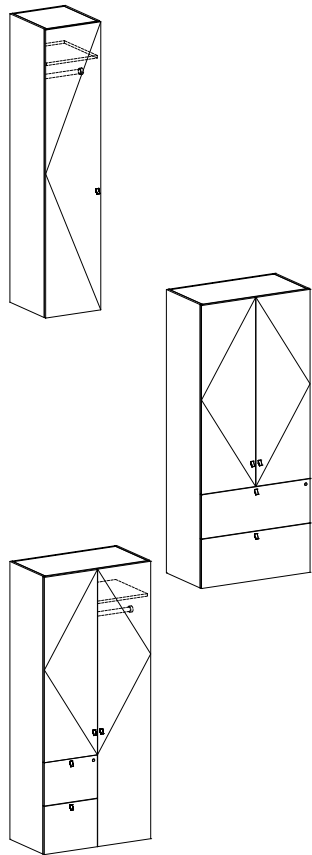

Description	Product No. List \$		Product No. List \$					
	20d		24d					
	Spec Code	▲	Spec Code	▲	Spec Code	Add \$	Spec Code	Add \$
	Wood1	Faces	Wood1	Faces	Acrylic	Faces	Mirror	
Garment 16w LH	GL16	3360	GL16	3729	A	1046	MR	169
Garment 16w RH	GR16	3360	GR16	3729	A	1046	MR	169
• Garment 18w LH	GL18	3524	GL18	3905	A	1046	MR	191
Garment 18w RH	GR18	3524	GR18	3905	A	1046	MR	191
Garment 20w LH	GL20	3658	GL20	4047	A	1046	MR	212
Garment 20w RH	GR20	3658	GR20	4047	A	1046	MR	212
Garment 24w LH	GL24	3894	GL24	4284	A	1046	MR	254
Garment 24w RH	GR24	3894	GR24	4284	A	1046	MR	254
Cab4:2File 16w LH	HL16	4195	HL16	4699	A	1046	MR	—
Cab4:2File 16w RH	HR16	4195	HR16	4699	A	1046	MR	—
Cab4:2File 18w LH	HL18	4372	HL18	4858	A	1046	MR	—
Cab4:2File 18w RH	HR18	4372	HR18	4858	A	1046	MR	—
Cab4:2File 20w LH	HL20	4536	HL20	5068	A	1046	MR	—
Cab4:2File 20w RH	HR20	4536	HR20	5068	A	1046	MR	—
Cab4:2File 24w DBL	H24	4809	H24	5372	A	1046	MR	—
• Cab4:2File 30w DBL	H30	5114	H30	5682	A	1046	MR	—
Cab4:2File 36w DBL	H36	5387	H36	5955	A	1046	MR	—
Cab4/2F 16:Gmt8 24w DBL	JA24	5142	JA24	5825	A	1046	MR	—
Gmt8:Cab4/2F 16 24w DBL	JB24	5142	JB24	5825	A	1046	MR	—
Cab4/2F 18:Gmt12 30w DBL	JA30	5381	JA30	6113	A	1046	MR	317
Gmt12:Cab4/2F 18 30w DBL	JB30	5381	JB30	6113	A	1046	MR	317
• Cab4/2F 18:Gmt18 36w DBL	JA36	5617	JA36	6348	A	1046	MR	338
Gmt18:Cab4/2F 18 36w DBL	JB36	5617	JB36	6348	A	1046	MR	338

! Notes:

- All units have unfinished backs.
- LH and RH designations indicate hinge side on the single door units.
- 84.5h units have unfinished tops.
- For units with toe kick use prefix with toe kick.
- Toe kick finish is standard MRBAS, Brushed Aluminum w/Steel Tint; for polished specify MPA, Polished Aluminum.
- Pull finish is standard MRBAS, Brushed Aluminum w/Steel tint; for polished specify MPA, Polished Aluminum.
- Acrylic faces are Stylelite Arctic White standard.

+Options:

- To specify Acrylic faces add A to spec code and add \$ total amount.
- To specify mirror add MR to spec code and add \$ amount to total.
- For Door/Cabinet locks, specify LD; add \$210.
- For Drawer locks, specify LG add \$250.

