

PRICING & SPECIFICATION GUIDE
Prima Collection

May 1, 2023

TUOHY

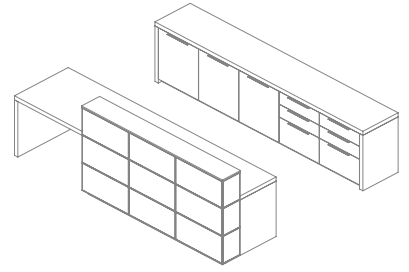

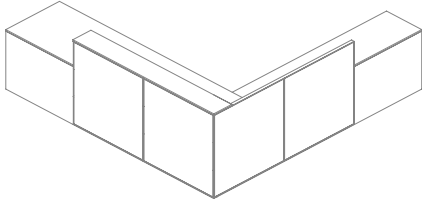

Reception: *Prima*

- | | |
|-----------------------------------|------|
| Desks, 0.5th Top | BP6 |
| Bridges, 0.5th Top | BP7 |
| Runoffs, 0.5th Top | BP7 |
| Desks, 2th Top | BP8 |
| Credenzas, 2th Top | BP8 |
| Bridges, 2th Top | BP8 |
| Runoffs, 2th Top | BP9 |
| Pedestals | BP10 |
| Support Keels | BP11 |
| Gallery Tops, 10.8d 0.5th* | BP12 |
| Gallery Backsplashes, 12.2h 1.5th | BP12 |
| Gallery Backsplash Magnet | BP13 |
| Gallery & Surround Tackboards | BP13 |
| Gallery Surround Panels | BP14 |
| - Wood1 | BP14 |
| - Polished Acrylic Solid Surface | BP16 |
| - 3Form® Reflect | BP18 |
| - Carrara Marble | BP20 |
| - Satin Brushed Nickel | BP22 |
| - Silex Faux Leather | BP24 |
| - Back-Painted Glass | BP26 |
| - Stainless Steel Wire Mesh | BP28 |
| - Gilded Cork | BP30 |

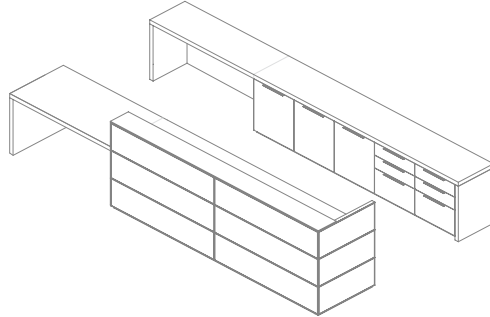

Design: John Nelson

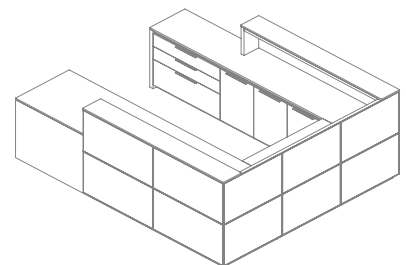
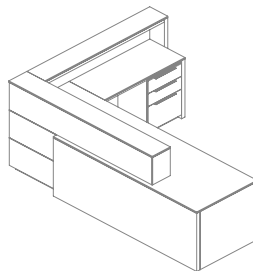
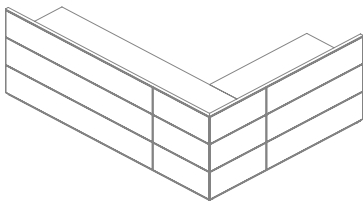
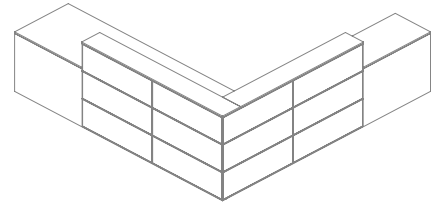
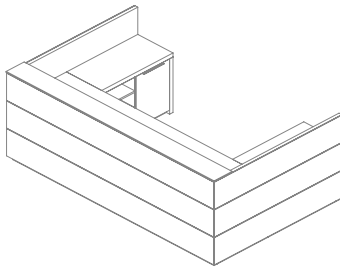
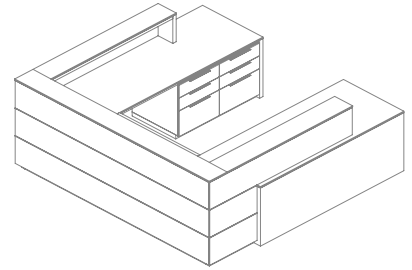

Drawer Layouts: Plan View

Slides: Side-Mount

Pedestal Units 18d
Drawers 16d

16w 20w 24w 28w 32w 36w

Box Drawers w Divider

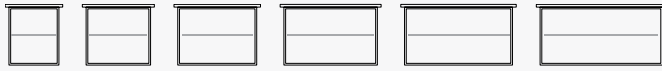

File Drawers: Lateral

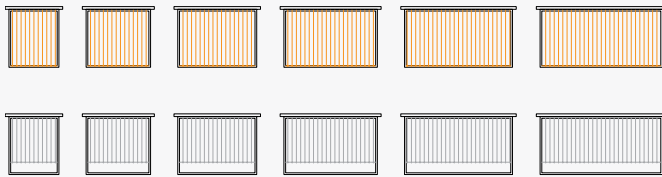

File Drawers: Front-to-Back



Pedestal Units 28d
Drawers 20.1d

16w 20w 24w 28w 32w 36w

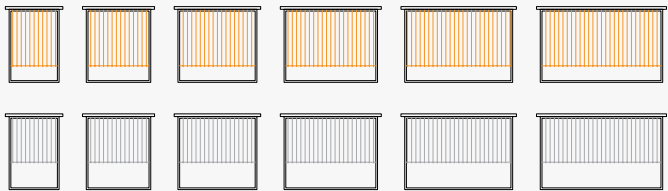
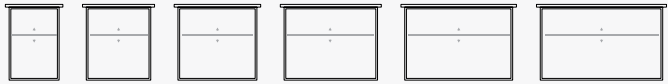

DRAWER CONSTRUCTION

A fine point for a quality casegood product is the inner drawer construction. Each TUOHY casegood offers you uncompromised excellence in this area as well. Drawer boxes are constructed with dovetail joinery for maximum durability. The drawer face is mounted separately to this box (i.e., five-sided construction) to maintain integrity.

Drawer bottoms are dadoed on all four sides. Slides for box drawers are rated at 100 pounds per drawer; slides for file drawers are rated at a heavy duty 150 pound load per drawer. All slides have progressive action.

Box drawers have a removable divider, adjustable when depicted (±). File drawers have file frames for filing laterally or front-to-back, as depicted. For Drawers for Lap Area, Drawer Pencil Tray, and Locks: See the Introduction/Terms-Options section of the Master Price List, page 12.

Desks, Credenzas, Bridges & Runoffs
See pages BP6 to BP10

Pedestals
See page BP11

Prima Collection is a highly flexible system of furniture components that combine to create an extensive, elegant and creative series of reception and administrative assistant workstations.

Simply configure desk, runoff, bridge and credenza shells to form in-line, L-shaped and U-shaped layouts. Add pedestals and situate galleries and/or surround panels as needed.

You have considerable flexibility in the scale and placement of these elements. Surround panels and gallery fronts may be defined in whatever segmented matrix and material you desire.

In addition to what is presented here, Prima has been designed to accept a nearly limitless range of customers' architectural and interior materials and finishes. Use Prima for maximum impact in reception areas, but with considerably less rigor and expense than custom millwork solutions.



0.5-inch Top, Closed Shell
0.5-inch Top, Closed Shell for Recessed Galleries
2-inch Top, Open Shell



Choose from the following in a range of widths and materials/finishes, and arrange in modular sequence:

- Shelving
- Cabinets
- Box and File Storage Drawers
- Trash/Recycle Drawers
- Utility Drawers

Add power/data accessories as needed.

Surround Panels and Galleries

See pages BP12 to BP37

Width & Placement Relative to Shell



Function and form are achieved by your relative placement of surround panels and galleries on the casework shells, whether centered, shifted left or shifted right by any dimension you desire.

Surround Panels are 2 inches thick, modular, and specified in left-to-right approach sequence at widths from 21 inches to 124 inches. Each surround panel is one segment wide by up to three segments tall (see 1x1, 1x2 and 1x3 at right). Surround panels may abut galleries.

Galleries are single mass, 10.8 inches deep, specified according to the desired matrix layout as shown at right. Galleries receive a transaction top and backsplash or tackable surface, all of which are specified separately.

All panels and galleries have a mitered/quirk detail at corners to perpendicular runs.

Matrix Layouts



Matrix Face Material / Matrix Edge / (user-side)

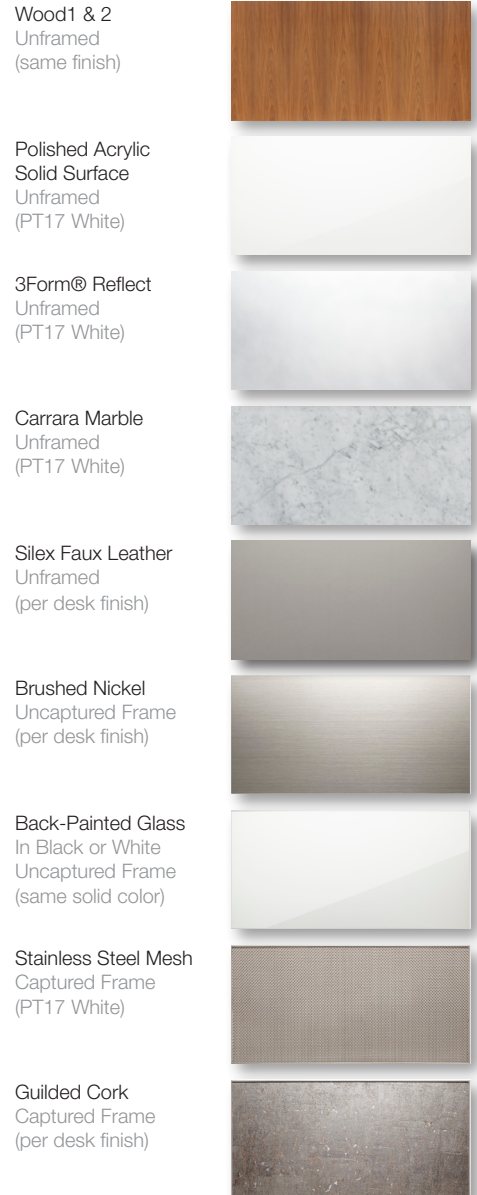

Desks, 0.5th Top

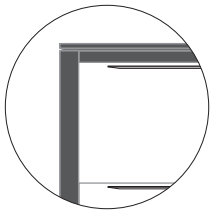

32d Wood1 Closed Shell	w	Wood1 Top	\$	BPGlass Top	\$	Solid Surface Top	\$
Desk/0.5Top 76w 32d 29.5h	76	PZDWC76	4733	PZDWC76	8559	PZDWCC76	6104
Desk/0.5Top 84w 32d 29.5h	84	PZDWC84	4982	PZDWC84	9206	PZDWCC84	6493
Desk/0.5Top 92w 32d 29.5h	92	PZDWC92	5178	PZDWC92	9808	PZDWCC92	6833
Desk/0.5Top 100w 32d 29.5h	100	PZDWC100	5377	PZDWC100	10410	PZDWCC100	7178
Desk/0.5Top 108w 32d 29.5h	108	PZDWC108	5576	PZDWC108	11007	PZDWCC108	7519
Desk/0.5Top 116w 32d 29.5h	116	PZDWC116	5773	PZDWC116	11611	PZDWCC116	7861
Desk/0.5Top 124w 32d 29.5h	124	PZDWC124	5971	PZDWC124	12210	PZDWCC124	8204

36d Wood1 Shell for Recessed Gallery	w	Wood1 Top	\$	BPGlass Top	\$	Solid Surface Top	\$
Desk/0.5Top-RecGal 76w 36d 29.5h LH	76	PZDRWC76L	4935	PZDRWC76L	9300	PZDRWCC76L	6535
Desk/0.5Top-RecGal 76w 36d 29.5h RH	76	PZDRWC76R	4935	PZDRWC76R	9300	PZDRWCC76R	6535
Desk/0.5Top-RecGal 84w 36d 29.5h LH	84	PZDRWC84L	5255	PZDRWC84L	9347	PZDRWCC84L	6633
Desk/0.5Top-RecGal 84w 36d 29.5h RH	84	PZDRWC84R	5255	PZDRWC84R	9347	PZDRWCC84R	6633
Desk/0.5Top-RecGal 92w 36d 29.5h LH	92	PZDRWC92L	5466	PZDRWC92L	10674	PZDRWCC92L	7330
Desk/0.5Top-RecGal 92w 36d 29.5h RH	92	PZDRWC92R	5466	PZDRWC92R	10674	PZDRWCC92R	7330
Desk/0.5Top-RecGal 100w 36d 29.5h LH	100	PZDRWC100L	5677	PZDRWC100L	11340	PZDRWCC100L	7704
Desk/0.5Top-RecGal 100w 36d 29.5h RH	100	PZDRWC100R	5677	PZDRWC100R	11340	PZDRWCC100R	7704
Desk/0.5Top-RecGal 108w 36d 29.5h LH	108	PZDRWC108L	5889	PZDRWC108L	12003	PZDRWCC108L	8076
Desk/0.5Top-RecGal 108w 36d 29.5h RH	108	PZDRWC108R	5889	PZDRWC108R	12003	PZDRWCC108R	8076
Desk/0.5Top-RecGal 116w 36d 29.5h LH	116	PZDRWC116L	6104	PZDRWC116L	12667	PZDRWCC116L	8450
Desk/0.5Top-RecGal 116w 36d 29.5h RH	116	PZDRWC116R	6104	PZDRWC116R	12667	PZDRWCC116R	8450
Desk/0.5Top-RecGal 124w 36d 29.5h LH	124	PZDRWC124L	6314	PZDRWC124L	13332	PZDRWCC124L	8824
Desk/0.5Top-RecGal 124w 36d 29.5h RH	124	PZDRWC124R	6314	PZDRWC124R	13332	PZDRWCC124R	8824

! Notes:

Specify wood species/color from TUOHY Wood1 offerings; inquire about upcharges for Wood2 finishes or custom finishes. Standard Solid Surface offering is Avonite® Polaris, Matte.

+ Options/Parametrics:

Width range: 68-124; specify by replacing the last digits of the product number and use next larger standard size for pricing. BPGlass (Back-Painted Glass) panels available in S.BLK Black and S.BWT White; match colors on special request.

Credenzas, 0.5th Top

21d Wood1 Closed Shell	w	Wood1 Top	\$	BPGlass Top	\$	Solid Surface Top	\$	Option
Credenza 76w 21d 29.5h	76	PZCSWC76	4108	PZCSWC76	6618	PZCSWCC76	5004	+903
Credenza 84w 21d 29.5h	84	PZCSWC84	4236	PZCSWC84	7007	PZCSWCC84	5227	+999
Credenza 92w 21d 29.5h	92	PZCSWC92	4364	PZCSWC92	7403	PZCSWCC92	5450	+1095
Credenza 100w 21d 29.5h	100	PZCSWC100	4492	PZCSWC100	7792	PZCSWCC100	5672	+1190
Credenza 108w 21d 29.5h	108	PZCSWC108	4620	PZCSWC108	8185	PZCSWCC108	5893	+1285
Credenza 116w 21d 29.5h	116	PZCSWC116	4747	PZCSWC116	8574	PZCSWCC116	6116	+1382
Credenza 124w 21d 29.5h	124	PZCSWC124	4875	PZCSWC124	8968	PZCSWCC124	6338	+1474

! Notes:

Specify wood species/color from TUOHY Wood1 offerings; inquire about upcharges for Wood2 finishes or custom finishes. Standard Solid Surface offering is Avonite® Polaris, Matte.

+ Options/Parametrics:

Width range: 60-124; specify by replacing the last digits of the product number and use next larger standard size for pricing. BPGlass (Back-Painted Glass) panels available in S.BLK Black and S.BWT White; match colors on special request. For Finished Back, specify Option FB; add the amount as shown in the far right column.

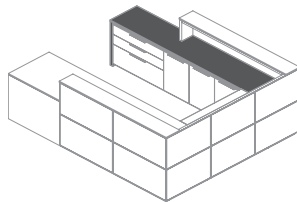

Specify: Product Number
Quantity
Color/Finish
Tagging

‡ Requires field sub-assembly.

Bridges, 0.5th Top		21d Wood1 Closed Shell	w	Wood1 Top	\$	BPGlass Top	\$	Solid Surface Top	\$
		Bridge/0.5Top 40w 21d 29.5h	40	PZBWC40	1399	PZBWC40	2720	PZBWC40	1872
		Bridge/0.5Top 48w 21d 29.5h	48	PZBWC48	1467	PZBWC48	3052	PZBWC48	2035

! Notes:

Specify wood species/color from TUOHY Wood1 offerings; inquire about upcharges for Wood2 finishes or custom finishes.
Standard Solid Surface offering is Avonite® Polaris, Matte.

+ Options/Parametrics:

Width range: 36-48; specify by modifying the last two digits of the product number and use next larger standard size for pricing.
BPGlass (Back-Painted Glass) panels available in S.BLK Black and S.BWT White; match colors on special request.

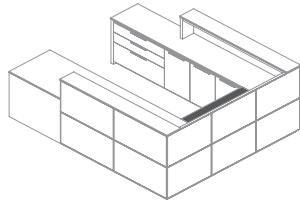

Runoffs, 0.5th Top

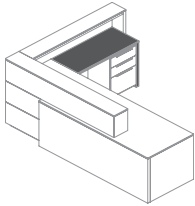

Runoffs, 0.5th Top		21d Wood1 Closed Shell	w	Wood1 Top	\$	BPGlass Top	\$	Solid Surface Top	\$
		Runoff/0.5Top 40w 21d 29.5h LH	40	PZRSWC40L	2867	PZRSWC40L	4186	PZRSWC40L	3339
		Runoff/0.5Top 40w 21d 29.5h RH	40	PZRSWC40R	2867	PZRSWC40R	4186	PZRSWC40R	3339
		Runoff/0.5Top 48w 21d 29.5h LH	48	PZRSWC48L	3031	PZRSWC48L	4591	PZRSWC48L	3573
		Runoff/0.5Top 48w 21d 29.5h RH	48	PZRSWC48R	3031	PZRSWC48R	4591	PZRSWC48R	3573
		Runoff/0.5Top 56w 21d 29.5h LH	56	PZRSWC56L	3194	PZRSWC56L	4994	PZRSWC56L	3808
		Runoff/0.5Top 56w 21d 29.5h RH	56	PZRSWC56R	3194	PZRSWC56R	4994	PZRSWC56R	3808
		Runoff/0.5Top 64w 21d 29.5h LH	64	PZRSWC64L	3357	PZRSWC64L	5399	PZRSWC64L	4040
		Runoff/0.5Top 64w 21d 29.5h RH	64	PZRSWC64R	3357	PZRSWC64R	5399	PZRSWC64R	4040
		Runoff/0.5Top 72w 21d 29.5h LH	72	PZRSWC72L	3520	PZRSWC72L	5803	PZRSWC72L	4276
		Runoff/0.5Top 72w 21d 29.5h RH	72	PZRSWC72R	3520	PZRSWC72R	5803	PZRSWC72R	4276
		Runoff/0.5Top 80w 21d 29.5h LH	80	PZRSWC80L	3681	PZRSWC80L	6207	PZRSWC80L	4508
		Runoff/0.5Top 80w 21d 29.5h RH	80	PZRSWC80R	3681	PZRSWC80R	6207	PZRSWC80R	4508
		Runoff/0.5Top 88w 21d 29.5h LH	88	PZRSWC88L	3846	PZRSWC88L	6608	PZRSWC88L	4744
		Runoff/0.5Top 88w 21d 29.5h RH	88	PZRSWC88R	3846	PZRSWC88R	6608	PZRSWC88R	4744
		Runoff/0.5Top 96w 21d 29.5h LH	96	PZRSWC96L	4007	PZRSWC96L	7011	PZRSWC96L	4975
		Runoff/0.5Top 96w 21d 29.5h RH	96	PZRSWC96R	4007	PZRSWC96R	7011	PZRSWC96R	4975

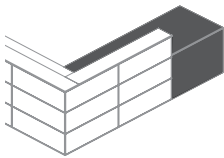

Runoffs, 0.5th Top		32d Wood1 Closed Shell	w	Wood1 Top	\$	BPGlass Top	\$	Solid Surface Top	\$
		Runoff/0.5Top 40w 32d 29.5h LH	40	PZRRWC40L	3114	PZRRWC40L	5127	PZRRWC40L	3834
		Runoff/0.5Top 40w 32d 29.5h RH	40	PZRRWC40R	3114	PZRRWC40R	5127	PZRRWC40R	3834
		Runoff/0.5Top 48w 32d 29.5h LH	48	PZRRWC48L	3302	PZRRWC48L	5696	PZRRWC48L	4140
		Runoff/0.5Top 48w 32d 29.5h RH	48	PZRRWC48R	3302	PZRRWC48R	5696	PZRRWC48R	4140
		Runoff/0.5Top 56w 32d 29.5h LH	56	PZRRWC56L	3488	PZRRWC56L	6256	PZRRWC56L	4447
		Runoff/0.5Top 56w 32d 29.5h RH	56	PZRRWC56R	3488	PZRRWC56R	6256	PZRRWC56R	4447
		Runoff/0.5Top 64w 32d 29.5h LH	64	PZRRWC64L	3672	PZRRWC64L	6824	PZRRWC64L	4754
		Runoff/0.5Top 64w 32d 29.5h RH	64	PZRRWC64R	3672	PZRRWC64R	6824	PZRRWC64R	4754
		Runoff/0.5Top 72w 32d 29.5h LH	72	PZRRWC72L	3861	PZRRWC72L	7389	PZRRWC72L	5062
		Runoff/0.5Top 72w 32d 29.5h RH	72	PZRRWC72R	3861	PZRRWC72R	7389	PZRRWC72R	5062
		Runoff/0.5Top 80w 32d 29.5h LH	80	PZRRWC80L	4046	PZRRWC80L	7954	PZRRWC80L	5369
		Runoff/0.5Top 80w 32d 29.5h RH	80	PZRRWC80R	4046	PZRRWC80R	7954	PZRRWC80R	5369
		Runoff/0.5Top 88w 32d 29.5h LH	88	PZRRWC88L	4234	PZRRWC88L	8519	PZRRWC88L	5675
		Runoff/0.5Top 88w 32d 29.5h RH	88	PZRRWC88R	4234	PZRRWC88R	8519	PZRRWC88R	5675
		Runoff/0.5Top 96w 32d 29.5h LH	96	PZRRWC96L	4419	PZRRWC96L	9087	PZRRWC96L	5982
		Runoff/0.5Top 96w 32d 29.5h RH	96	PZRRWC96R	4419	PZRRWC96R	9087	PZRRWC96R	5982

! Notes:

Specify wood species/color from TUOHY Wood1 offerings; inquire about upcharges for Wood2 finishes or custom finishes.
Handedness is user's side attachment to Desk.
Standard Solid Surface offering is Avonite® Polaris, Matte.

+ Options/Parametrics:

Width range: 36-96; specify by replacing the last digits of the product number and use next larger standard size for pricing.
BPGlass (Back-Painted Glass) panels available in S.BLK Black and S.BWT White; match colors on special request.

Desks, 2th Top



32d Wood1	w	Open Shell	\$
Desk/2Top 76w 32d 29.5h	76	PZDW76	4256
Desk/2Top 84w 32d 29.5h	84	PZDW84	4445
Desk/2Top 92w 32d 29.5h	92	PZDW92	4629
Desk/2Top 100w 32d 29.5h	100	PZDW100	4815
Desk/2Top 108w 32d 29.5h	108	PZDW108	5002
Desk/2Top 116w 32d 29.5h	116	PZDW116	5187
Desk/2Top 124w 32d 29.5h	124	PZDW124	5375

! Notes:

Specify wood species/color from TUOHY Wood1 offerings; inquire about upcharges for Wood2 finishes or custom finishes. Maximum open span under desk tops is 56-in; use pedestals and Support Keels as needed.

+ Options/Parametrics:

Width range: 68-124; specify by replacing the last digits of the product number and use next larger standard size for pricing.

Credenzas, 2th Top

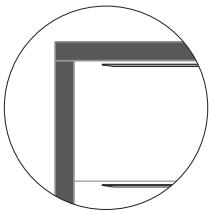

21d Wood1	w	Closed Shell	\$	Option FB
Credenza/2Top 76w 21d 29.5h	76	PZCSW76	4305	+147
Credenza/2Top 84w 21d 29.5h	84	PZCSW84	4481	+163
Credenza/2Top 92w 21d 29.5h	92	PZCSW92	4659	+176
Credenza/2Top 100w 21d 29.5h	100	PZCSW100	4837	+192
Credenza/2Top 108w 21d 29.5h	108	PZCSW108	5017	+209
Credenza/2Top 116w 21d 29.5h	116	PZCSW116	5193	+224
Credenza/2Top 124w 21d 29.5h	124	PZCSW124	5370	+239

! Notes:

Specify wood species/color from TUOHY Wood1 offerings; inquire about upcharges for Wood2 finishes or custom finishes. Maximum open span under Credenza Tops is 56-in; use pedestals and Support Keels as needed.

+ Options/Parametrics:

Width range: 60-124; specify by replacing the last digits of the product number and use next larger standard size for pricing.

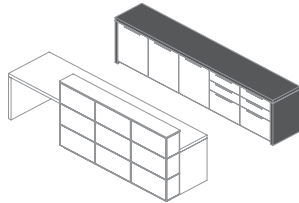

Bridges, 2th Top

21d Wood1	w	Open Shell	\$	Closed Shell	\$
Bridge/2Top 40w 21d 29.5h	40	PZBW40	1161	PZBWB40	2355
Bridge/2Top 48w 21d 29.5h	48	PZBW48	1222	PZBWB48	2511

! Notes:

Specify wood species/color from TUOHY Wood1 offerings; inquire about upcharges for Wood2 finishes or custom finishes.

+ Options/Parametrics:

Width range: 36-48; specify by modifying the last two digits of the product number and use next larger standard size for pricing.

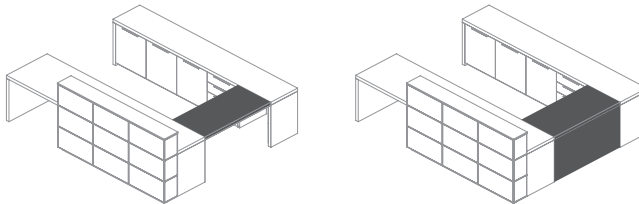

Runoffs, 2th Top	21d Wood1	w	Open Shell	\$	Closed Shell LH	\$	Closed Shell RH	\$
	Runoff Shell 40w 21d 29.5h	40	PZRSW40	2171	PZRSWB40L	2659	PZRSWB40R	2659
	Runoff Shell 48w 21d 29.5h	48	PZRSW48	2244	PZRSWB48L	2826	PZRSWB48R	2826
	Runoff Shell 56w 21d 29.5h	56	PZRSW56	2316	PZRSWB56L	2991	PZRSWB56R	2991
	Runoff Shell 64w 21d 29.5h	64	PZRSW64	2386	PZRSWB64L	3162	PZRSWB64R	3162
	Runoff Shell 72w 21d 29.5h	72	PZRSW72	2458	PZRSWB72L	3421	PZRSWB72R	3421
	Runoff Shell 80w 21d 29.5h	80	PZRSW80	2528	PZRSWB80L	3492	PZRSWB80R	3492
	Runoff Shell 88w 21d 29.5h	88	PZRSW88	2601	PZRSWB88L	3657	PZRSWB88R	3657
	Runoff Shell 96w 21d 29.5h	96	PZRSW96	2672	PZRSWB96L	3825	PZRSWB96R	3825
	32d Wood1	w	Open Shell	\$	Closed Shell LH	\$	Closed Shell RH	\$
	Runoff Shell 40w 32d 29.5h	40	PZRRW40	2490	PZRRWB40L	2848	PZRRWB40R	2848
	Runoff Shell 48w 32d 29.5h	48	PZRRW48	2598	PZRRWB48L	3050	PZRRWB48R	3050
	Runoff Shell 56w 32d 29.5h	56	PZRRW56	2710	PZRRWB56L	3255	PZRRWB56R	3255
	Runoff Shell 64w 32d 29.5h	64	PZRRW64	2816	PZRRWB64L	3459	PZRRWB64R	3459
	Runoff Shell 72w 32d 29.5h	72	PZRRW72	2924	PZRRWB72L	3758	PZRRWB72R	3758
	Runoff Shell 80w 32d 29.5h	80	PZRRW80	3033	PZRRWB80L	3863	PZRRWB80R	3863
	Runoff Shell 88w 32d 29.5h	88	PZRRW88	3142	PZRRWB88L	4071	PZRRWB88R	4071
	Runoff Shell 96w 32d 29.5h	96	PZRRW96	3251	PZRRWB96L	4275	PZRRWB96R	4275

! Notes:

Specify wood species/color from TUOHY Wood1 offerings; inquire about upcharges for Wood2 finishes or custom finishes.
 Maximum open span under runoff tops is 56-in; use pedestals and Support Keels as needed.

+ Options/Parametrics:

Width range: 36-96; specify by replacing the last digits of the product number and use next larger standard size for pricing.

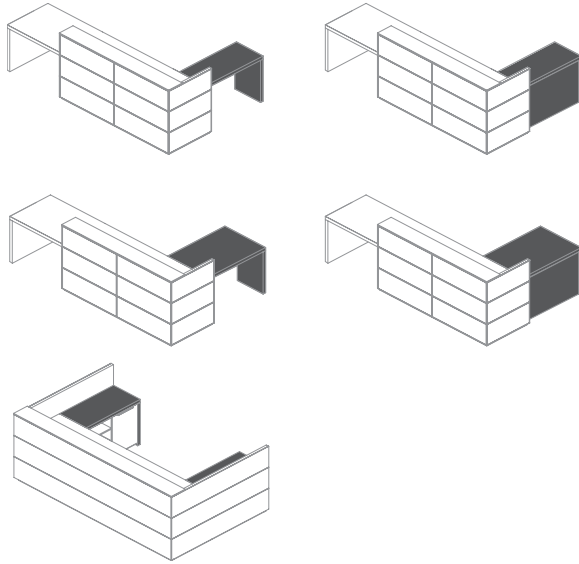

Pedestals	Wood1, Unfinished Back and Sides (shell required)	18d		28d	
	Pedestals	PZPED18	\$ sum	PZPED28	\$ sum
		Spec Code	▲	Spec Code	▲
	Open Shelving 16w	F16	1765	F16	1959
	Open Shelving 20w	F20	1868	F20	2099
	Open Shelving 24w	F24	1970	F24	2237
	Open Shelving 28w	F28	2071	F28	2374
	Open Shelving 32w	F32	2175	F32	2514
	Open Shelving 36w	F36	2276	F36	2650
	Cabinet w/Shelf 16w LH	GL16	2808	GL16	3000
	Cabinet w/Shelf 16w RH	GR16	2808	GR16	3000
	Cabinet w/Shelf 20w LH	GL20	2952	GL20	3180
	Cabinet w/Shelf 20w RH	GR20	2952	GR20	3180
	Cabinet w/Shelf 24w LH	GL24	3094	GL24	3360
	Cabinet w/Shelf 24w RH	GR24	3094	GR24	3360
	Cabinet w/Shelf 28w DBL	GD28	3290	GD28	3593
	Cabinet w/Shelf 32w DBL	GD32	3432	GD32	3773
	Cabinet w/Shelf 36w DBL	GD36	3577	GD36	3952
		4Box 16w	M16	3880	M16
4Box 20w		M20	3985	M20	4114
4Box 24w		M24	4148	M24	4296
4Box 28w		M28	4311	M28	4475
4Box 32w		M32	4416	M32	4597
4Box 36w		M36	4563	M36	4760
	2Box/File 16w	L16	2947	L16	3056
	2Box/File 20w	L20	3046	L20	3172
	2Box/File 24w	L24	3193	L24	3332
	2Box/File 28w	L28	3357	L28	3514
	2Box/File 32w	L32	3459	L32	3630
	2Box/File 36w	L36	3593	L36	3780
	2File 16w	K16	2860	K16	2965
	2File 20w	K20	2957	K20	3074
	2File 24w	K24	3085	K24	3217
	2File 28w	K28	3251	K28	3402
	2File 32w	K32	3350	K32	3509
	2File 36w	K36	3467	K36	3666
	Utility Drawer 20w	W20	2925	W20	3231
	Utility Drawer 24w	W24	3061	W24	3453
	TrashRecycle 20w: Dwr/Bin(18d) Dwr/2Bins(28d)	Y20	2857	Y20	3007
	TrashRecycle 24w: Dwr/2Bins(18d) 4Bins(28d)	Y24	3004	Y24	3936
	Removable KneePanel 16w	R16	757	R16	757
	Removable KneePanel 20w	R20	782	R20	782
	Removable KneePanel 24w	R24	811	R24	811
	Removable KneePanel 28w	R28	836	R28	836
	Removable KneePanel 32w	R32	862	R32	862
	Removable KneePanel 36w	R36	886	R36	886

(See Notes and Options on the opposite page.)

Pedestals (cont.)



! Notes:

To order, specify the Product Number listed at top, then list the Spec Codes in L to R order in your description.
 The maximum width of a pedestal run under one shell is 120 inches.
 The total price is the sum of the Spec Code prices you itemized.
 Order Shells for Desks, Runoffs, Bridges and Credenzas separately, from the listings on prior pages.
 Utility Drawers include a vent/cord exit in the rear panel.
 Cabinet doors have soft-close hinges.

+ Options:

Specify metal pull and toeboard finish: MSBN Satin Brushed Nickel or MPNA Polished Natural Aluminum;
 (for MPNA Polished Natural Aluminum, refer to Wilsonart® 6251-419).
 Face Locks are included on all drawer and door pedestals. For no locks, specify Option NL.
 For ventilation cutout (where not included), specify Option VS; add \$448.
 For a secondary Wood1 selection on door/drawer fronts, specify Option W1F; add \$269.
 For finished left side, specify Option FL; add \$162.
 For finished right side, specify Option FR; add \$162.
 For finished both sides, specify Option FS; add \$320.

Support Keels



‡	w	2d	1h	MRB Resin Black	
Support Keel: 56	56			LG-56	442
Support Keel: 60	60			LG-60	456
Support Keel: 64	64			LG-64	461
Support Keel: 72	72			LG-72	469
Support Keel: 80	80			LG-80	478
• Support Keel: 88	88			LG-88	488

! Notes:

Required for unsupported work surface spans of 56 inches or more.
 Unit is an MRB Resin Black, 1 x 2 steel tube screwed to the underside of the work surface.

Gallery Tops, 10.8d 0.5th*

	Wood1	SolidSurf Matte	BPGlass	Etched Glass	Carrara Marble	MRBAS Br Alum/St
Gallery Top 40w	PZGTW40	879	PZGTC40 1225	PZGTG40 1672	PZGTJ40 2074	PZGTS40 1911 PZGTA40 3690
Gallery Top 44w	PZGTW44	888	PZGTC44 1262	PZGTG44 1752	PZGTJ44 2197	PZGTS44 2017 PZGTA44 3973
Gallery Top 48w	PZGTW48	900	PZGTC48 1297	PZGTG48 1830	PZGTJ48 2317	PZGTS48 2122 PZGTA48 4254
Gallery Top 52w	PZGTW52	910	PZGTC52 1334	PZGTG52 1911	PZGTJ52 2438	PZGTS52 2228 PZGTA52 4539
Gallery Top 56w	PZGTW56	919	PZGTC56 1368	PZGTG56 1996	PZGTJ56 2558	PZGTS56 2333 PZGTA56 4821
Gallery Top 60w	PZGTW60	930	PZGTC60 1406	PZGTG60 2074	PZGTJ60 2680	PZGTS60 2438 PZGTA60 5104
Gallery Top 64w	PZGTW64	939	PZGTC64 1443	PZGTG64 2155	PZGTJ64 2799	PZGTS64 2542 PZGTA64 5385
Gallery Top 68w	PZGTW68	949	PZGTC68 1481	PZGTG68 2237	PZGTJ68 2922	PZGTS68 2647 PZGTA68 5669
Gallery Top 72w	PZGTW72	959	PZGTC72 1518	PZGTG72 2317	PZGTJ72 3044	PZGTS72 2752 PZGTA72 5954
Gallery Top 76w	PZGTW76	967	PZGTC76 1554	PZGTG76 2398	PZGTJ76 3166	PZGTS76 2857 PZGTA76 6234
Gallery Top 80w	PZGTW80	979	PZGTC80 1591	PZGTG80 2477	PZGTJ80 3288	PZGTS80 2963 PZGTA80 6518
Gallery Top 84w	PZGTW84	988	PZGTC84 1626	PZGTG84 2558	PZGTJ84 3405	PZGTS84 3068 PZGTA84 6802
Gallery Top 88w	PZGTW88	998	PZGTC88 1663	PZGTG88 2642	PZGTJ88 3528	PZGTS88 3173 PZGTA88 7082
Gallery Top 92w	PZGTW92	1007	PZGTC92 1698	PZGTG92 2720	PZGTJ92 3649	PZGTS92 3276 PZGTA92 7367
Gallery Top 96w	PZGTW96	1015	PZGTC96 1736	PZGTG96 2799	PZGTJ96 3768	PZGTS96 3384 PZGTA96 7647
Gallery Top 100w	PZGTW100	1027	PZGTC100 1770	PZGTG100 2883	-	PZGTS100 3488 PZGTA100 7931
Gallery Top 104w	PZGTW104	1036	PZGTC104 1808	-	-	PZGTS104 3595 PZGTA104 8213
Gallery Top 108w	PZGTW108	1046	PZGTC108 1844	-	-	PZGTS108 3698 PZGTA108 8498
Gallery Top 112w	PZGTW112	1055	PZGTC112 1878	-	-	PZGTS112 3805 PZGTA112 8779
Gallery Top 116w	PZGTW116	1066	PZGTC116 1916	-	-	PZGTS116 3907 PZGTA116 9064
Gallery Top 120w	PZGTW120	1075	PZGTC120 1951	-	-	PZGTS120 4011 PZGTA120 9346
Gallery Top 124w	PZGTW124	1087	PZGTC124 1990	-	-	PZGTS124 4118 PZGTA124 9626

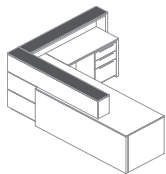

! Notes:

To order, specify product number and list price is as shown; Identify which gallery is to receive each specified top.

* All tops are 0.5 inch thick plus a 0.25 inch subtop reveal spacer.

Solid Surface material is Avonite® Polaris, matte.

+ Options/Parametrics:

Width range: 10-124; specify by replacing the last digits of the product number and use next larger standard size for pricing.

BPGlass (Back-Painted) available in S.BLK Black or S.BWT White; Etched Glass available in GAB Black or GAW White.

Gallery Backsplashes, 12.2h 1.5th

	Wood1/Magnet	SolidSurf Gloss	BPGlass/Magnet	Etch Glass/Magnet	Metal/Magnet
Gallery Backsplash 40w	PZGBW40	1504	PZGBC40 1705	PZGBG40 1841	PZGBJ40 2264 PZGBMM40 1534
Gallery Backsplash 44w	PZGBW44	1542	PZGBC44 1756	PZGBG44 1903	PZGBJ44 2372 PZGBMM44 1569
Gallery Backsplash 48w	PZGBW48	1582	PZGBC48 1809	PZGBG48 1970	PZGBJ48 2479 PZGBMM48 1603
Gallery Backsplash 52w	PZGBW52	1619	PZGBC52 1859	PZGBG52 2034	PZGBJ52 2589 PZGBMM52 1639
Gallery Backsplash 56w	PZGBW56	1657	PZGBC56 1911	PZGBG56 2100	PZGBJ56 2694 PZGBMM56 1673
Gallery Backsplash 60w	PZGBW60	1693	PZGBC60 1965	PZGBG60 2164	PZGBJ60 2802 PZGBMM60 1707
Gallery Backsplash 64w	PZGBW64	1729	PZGBC64 2013	PZGBG64 2229	PZGBJ64 2912 PZGBMM64 1742
Gallery Backsplash 68w	PZGBW68	1768	PZGBC68 2067	PZGBG68 2292	PZGBJ68 3019 PZGBMM68 1777
Gallery Backsplash 72w	PZGBW72	1806	PZGBC72 2117	PZGBG72 2359	PZGBJ72 3128 PZGBMM72 1812
Gallery Backsplash 76w	PZGBW76	1843	PZGBC76 2170	PZGBG76 2424	PZGBJ76 3235 PZGBMM76 1846
Gallery Backsplash 80w	PZGBW80	1878	PZGBC80 2222	PZGBG80 2490	PZGBJ80 3340 PZGBMM80 1882
Gallery Backsplash 84w	PZGBW84	1916	PZGBC84 2275	PZGBG84 2555	PZGBJ84 3452 PZGBMM84 1915
Gallery Backsplash 88w	PZGBW88	1954	PZGBC88 2325	PZGBG88 2619	PZGBJ88 3557 PZGBMM88 1950
Gallery Backsplash 92w	PZGBW92	1994	PZGBC92 2377	PZGBG92 2684	PZGBJ92 3665 PZGBMM92 1983
Gallery Backsplash 96w	PZGBW96	2031	PZGBC96 2429	PZGBG96 2751	PZGBJ96 3774 PZGBMM96 2020

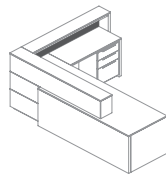

! Notes:

To order, specify product number and list price is as shown; Identify which gallery is to receive each specified backplash.

Wood1 includes all Wood1 veneer species and solid paint colors; inquire regarding other species/colors.

Standard Metal finish is MSBN Satin Brushed Nickel.

Solid Surface material is Avonite® Polaris, polished.

All Backsplash Panels with the Magnet designation accept CNL Magnets listed on the following page.

For widths greater than what is listed, combine two or more panels as needed to fill the desired opening.

+ Options/Parametrics:

Width range: 10-124; specify by replacing the last digits of the product number and use next larger standard size for pricing.

BPGlass (Back-Painted) available in S.BLK Black or S.BWT White; Etched Glass available in GAB Black or GAW White.

Gallery Backsplash Magnet



For Magnet-Ready Backsplashes	w	d	Product No.	\$
Magnet	0.8	0.8	CNL	110

! Note:
Standard finish is MRBS Resin Brushed Steel.

Gallery & Surround Tackboards

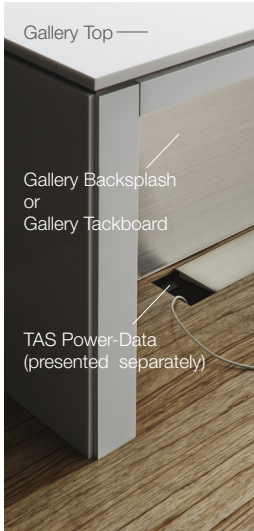

12.2h 1th	w	yds	Prod.No.	COM	F1	F2	F3	F4	F5	F6	F7	F8
Tackboard 40w	40	1.3	PZFT40	483	570	581	592	605	620	636	655	675
Tackboard 44w	44	1.4	PZFT44	512	606	617	630	644	659	677	697	719
Tackboard 48w	48	1.5	PZFT48	573	674	686	699	714	731	750	771	795
Tackboard 52w	52	1.6	PZFT52	617	724	737	751	767	785	806	828	854
Tackboard 56w	56	1.7	PZFT56	667	781	795	810	827	846	868	891	919
Tackboard 60w	60	1.8	PZFT60	737	858	872	888	906	926	949	975	1003
Tackboard 64w	64	1.9	PZFT64	767	894	910	927	946	967	991	1018	1048
Tackboard 68w	68	2.1	PZFT68	806	947	964	982	1003	1027	1054	1083	1117
Tackboard 72w	72	2.2	PZFT72	823	970	988	1008	1030	1054	1083	1113	1149
Tackboard 76w	76	2.3	PZFT76	845	999	1018	1038	1061	1087	1116	1149	1185
Tackboard 80w	80	2.4	PZFT80	872	1033	1052	1074	1098	1124	1155	1189	1227
Tackboard 84w	84	2.5	PZFT84	899	1067	1087	1109	1134	1162	1194	1229	1269
Tackboard 88w	88	2.6	PZFT88	925	1099	1120	1143	1169	1198	1232	1268	1310
Tackboard 92w	92	2.7	PZFT92	949	1130	1152	1176	1203	1233	1268	1305	1349
Tackboard 96w	96	2.8	PZFT96	1007	1195	1217	1242	1270	1301	1337	1377	1421
Tackboard 100w	100	2.9	PZFT100	1031	1225	1249	1275	1304	1336	1373	1414	1460
Tackboard 104w	104	3.1	PZFT104	1057	1265	1290	1317	1348	1383	1423	1466	1516
Tackboard 108w	108	3.2	PZFT108	1087	1301	1327	1356	1388	1423	1465	1509	1561
Tackboard 112w	112	3.3	PZFT112	1114	1335	1362	1391	1424	1461	1503	1550	1602
Tackboard 116w	116	3.4	PZFT116	1143	1371	1398	1429	1463	1500	1544	1592	1646
Tackboard 120w	120	3.5	PZFT120	1183	1418	1446	1477	1512	1551	1596	1645	1701
Tackboard 124w	124	3.6	PZFT124	1230	1471	1500	1532	1568	1608	1655	1705	1763

	w	yds	Prod.No.	F9	F10	F11	F12	F13	F14	F15	F16	F17
Tackboard 40w	40	1.3	PZFT40	699	725	753	786	822	863	908	960	1017
Tackboard 44w	44	1.4	PZFT44	744	772	803	838	877	921	970	1026	1087
Tackboard 48w	48	1.5	PZFT48	822	852	885	923	965	1011	1064	1124	1190
Tackboard 52w	52	1.6	PZFT52	883	915	950	990	1035	1084	1140	1204	1275
Tackboard 56w	56	1.7	PZFT56	949	983	1021	1063	1111	1163	1223	1291	1366
Tackboard 60w	60	1.8	PZFT60	1036	1072	1111	1156	1207	1263	1326	1398	1477
Tackboard 64w	64	1.9	PZFT64	1082	1120	1162	1210	1263	1322	1388	1464	1548
Tackboard 68w	68	2.1	PZFT68	1155	1197	1243	1295	1354	1419	1493	1577	1669
Tackboard 72w	72	2.2	PZFT72	1188	1232	1281	1336	1397	1465	1542	1630	1727
Tackboard 76w	76	2.3	PZFT76	1227	1273	1323	1381	1445	1517	1597	1689	1790
Tackboard 80w	80	2.4	PZFT80	1270	1318	1371	1431	1498	1573	1657	1753	1858
Tackboard 84w	84	2.5	PZFT84	1314	1364	1419	1482	1552	1629	1717	1817	1927
Tackboard 88w	88	2.6	PZFT88	1357	1409	1466	1531	1604	1684	1775	1879	1994
Tackboard 92w	92	2.7	PZFT92	1397	1451	1511	1578	1654	1737	1832	1940	2059
Tackboard 96w	96	2.8	PZFT96	1472	1528	1589	1659	1738	1825	1923	2035	2158
Tackboard 100w	100	2.9	PZFT100	1512	1570	1634	1707	1788	1878	1979	2095	2223
Tackboard 104w	104	3.1	PZFT104	1572	1634	1702	1779	1866	1962	2071	2195	2331
Tackboard 108w	108	3.2	PZFT108	1618	1682	1753	1833	1922	2021	2133	2261	2402
Tackboard 112w	112	3.3	PZFT112	1662	1728	1800	1883	1975	2078	2193	2325	2470
Tackboard 116w	116	3.4	PZFT116	1707	1775	1850	1935	2030	2136	2255	2391	2540
Tackboard 120w	120	3.5	PZFT120	1764	1834	1911	1999	2097	2205	2328	2468	2622
Tackboard 124w	124	3.6	PZFT124	1828	1900	1979	2069	2170	2281	2407	2551	2710

! Notes:
To order, specify Product Number; list price is as shown by fabric grade.
Identify which gallery or panel is to receive each specified tackboard.
Yardage requirements shown above are sufficient to cover up to four panels, assuming 54w material.
IMPORTANT: Refer to the Upholstery Guide on p.8 of the TUOHY List Price Schedule for COM fabric ordering information.
+ Options/Parametrics:
Width range: 10-124; replace the last digits of the Prod.No. and use the next larger standard size for price and yardage.



Gallery Surround Panels
Wood1
Unframed

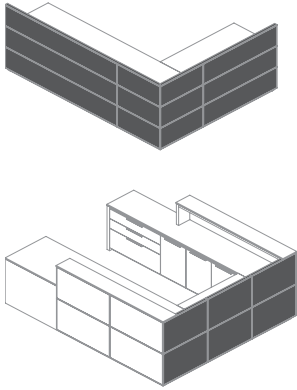

2d 43.8h	Prefix Code/Width Code:		Matrix Code:		
	PZG1W...1x1	...1x2	...1x3
Gallery/Surround W1 21w	...21...		3774	4837	5760
Gallery/Surround W1 24w	...24...		3951	5007	5940
Gallery/Surround W1 28w	...28...		4104	5168	6098
Gallery/Surround W1 32w	...32...		4227	5295	6224
Gallery/Surround W1 36w	...36...		4360	5426	6357
Gallery/Surround W1 40w	...40...		4467	5531	6464
Gallery/Surround W1 44w	...44...		4565	5624	6547
Gallery/Surround W1 48w	...48...		4669	5731	6655
Gallery/Surround W1 52w	...52...		4780	5834	6760
Gallery/Surround W1 56w	...56...		4983	6041	6966
Gallery/Surround W1 60w	...60...		5114	6173	7098
Gallery/Surround W1 64w	...64...		5234	6295	7221
Gallery/Surround W1 68w	...68...		5361	6423	7348
Gallery/Surround W1 72w	...72...		5493	6558	7481
Gallery/Surround W1 76w	...76...		5630	6696	7618
Gallery/Surround W1 80w	...80...		5749	6811	7741
Gallery/Surround W1 84w	...84...		5867	6926	7863
Gallery/Surround W1 88w	...88...		5991	7052	7991
Gallery/Surround W1 92w	...92...		6117	7178	8115
Gallery/Surround W1 96w	...96...		6246	7303	8240
Gallery/Surround W1 100w	...100...		6364	7429	8349
Gallery/Surround W1 104w	...104...		6807	7897	8731
Gallery/Surround W1 108w	...108...		6932	8023	8857
Gallery/Surround W1 112w	...112...		7078	8153	9001
Gallery/Surround W1 116w	...116...		7197	8282	9129
Gallery/Surround W1 120w	...120...		7315	8397	9246
Gallery/Surround W1 124w	...124...		7439	8526	9373

! Notes:
Determine product number by merging Prefix, Width and Matrix Codes; reference the price. Ex: PZG1W211X1 = \$3774.
+ Options/Parametrics:
Width range: 8-124; specify as Width Code and use next larger standard size for pricing.

PT17 Satin White

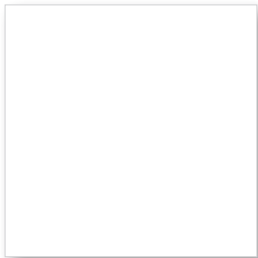

PT07 Matte Ebony



TUOHY Wood1 Species/Finishes, unframed.

19 standard hardwood offers, plus four solid color offerings.

TUOHY Wood2 species and finishes are also readily available, as are all the world's finest natural and reconstituted veneers. Inquire with Customer Service for a full presentation.

TUOHY

Specify: Product Number
Quantity
Color/Finish
Tagging

‡ Requires field sub-assembly.

Galleries for Desks & Credenzas
Wood1
Unframed

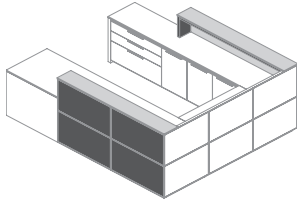

		Prefix Code/Width Code:	Matrix Code:								
10.8d	43.8h	PZG2W...	...1x1	...1x2	...1x3	...2x1	...2x2	...2x3	...3x1	...3x2	...3x3
Gallery/DeskCred W1 76w	...76...	8089	9567	10693	8470	9886	11447	8749	10217	11286	
Gallery/DeskCred W1 80w	...80...	8205	9686	10813	8591	10004	11565	8848	10296	11387	
Gallery/DeskCred W1 84w	...84...	8320	9793	10932	8709	10124	11683	8928	10415	11487	
Gallery/DeskCred W1 88w	...88...	8478	9952	11090	8869	10281	11842	9126	10611	11683	
Gallery/DeskCred W1 92w	...92...	8598	10072	11209	8986	10400	11962	9224	10693	11783	
Gallery/DeskCred W1 96w	...96...	8721	10198	11334	9112	10527	12088	9329	10817	11889	
Gallery/DeskCred W1 100w	...100...	8837	10317	11432	9218	10645	12206	9490	10978	12048	
Gallery/DeskCred W1 104w	...104...	9273	10779	11809	9668	11059	12761	10264	11651	12563	
Gallery/DeskCred W1 108w	...108...	9389	10898	11928	9784	11174	12881	10361	11772	12664	
Gallery/DeskCred W1 112w	...112...	9550	11042	12088	9947	11334	13040	10562	11969	12860	
Gallery/DeskCred W1 116w	...116...	9668	11170	12212	10072	11461	13165	10666	12054	12963	
Gallery/DeskCred W1 120w	...120...	9828	11325	12372	10231	11617	13323	10806	12212	13106	
Gallery/DeskCred W1 124w	...124...	9947	11447	12489	10349	11738	13442	10945	12372	13265	

! Notes:

Determine product number by merging Prefix, Width and Matrix Codes; reference the price. Ex: PZG2W761X1 = \$8089.
Order Gallery Top and Backsplash separately and tag to your selection here.
Designate placement of Gallery on Desk or Credenza as user's Left, Center or Right.

+ Options/Parametrics:

Width range: 60-124; specify as Width Code and use next larger standard size for pricing.

Galleries for Runoffs
Wood1
Unframed

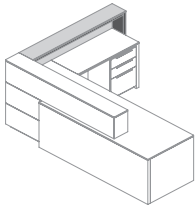

		Prefix Code/Width Code:	Matrix Code:								
10.8d	43.8h	PZG3W...	...1x1	...1x2	...1x3	...2x1	...2x2	...2x3	...3x1	...3x2	...3x3
Gallery/Runoff W1 40w LH	...40L...	6092	7154	8048	6473	7487	8307	6739	7791	8625	
Gallery/Runoff W1 40w RH	...40R...	6092	7154	8048	6473	7487	8307	6739	7791	8625	
Gallery/Runoff W1 48w LH	...48L...	6327	7388	8273	6721	7731	8551	6946	7995	8828	
Gallery/Runoff W1 48w RH	...48R...	6327	7388	8273	6721	7731	8551	6946	7995	8828	
Gallery/Runoff W1 56w LH	...56L...	6568	7625	8510	6958	7967	8789	7202	8233	9088	
Gallery/Runoff W1 56w RH	...56R...	6568	7625	8510	6958	7967	8789	7202	8233	9088	
Gallery/Runoff W1 64w LH	...64L...	6805	7867	8756	7187	8213	9033	7466	8518	9349	
Gallery/Runoff W1 64w RH	...64R...	6805	7867	8756	7187	8213	9033	7466	8518	9349	
Gallery/Runoff W1 72w LH	...72L...	7083	8148	9033	7466	8465	9312	7706	8756	9588	
Gallery/Runoff W1 72w RH	...72R...	7083	8148	9033	7466	8465	9312	7706	8756	9588	
Gallery/Runoff W1 80w LH	...80L...	7320	8386	9273	7706	8702	9550	7961	8994	9846	
Gallery/Runoff W1 80w RH	...80R...	7320	8386	9273	7706	8702	9550	7961	8994	9846	
Gallery/Runoff W1 88w LH	...88L...	7558	8614	9517	7952	8946	9793	8205	9279	10109	
Gallery/Runoff W1 88w RH	...88R...	7558	8614	9517	7952	8946	9793	8205	9279	10109	
Gallery/Runoff W1 96w LH	...96L...	7797	8853	9753	8187	9184	10032	8404	9475	10307	
Gallery/Runoff W1 96w RH	...96R...	7797	8853	9753	8187	9184	10032	8404	9475	10307	

! Notes:

Determine product number by merging Prefix, Width and Matrix Codes; reference the price. Ex: PZG3W40L1X1 = \$6092.
Order Gallery Top and Backsplash separately and tag to your selection here.

+ Options/Parametrics:

Width range: 32-96; specify as Width Code and use next larger standard size for pricing.

Galleries for Bridges
Wood1
Unframed

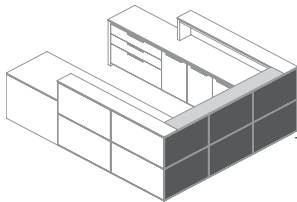

		Prefix Code/Width Code:	Matrix Code:								
10.8d	43.8h	PZG4W...	...1x1	...1x2	...1x3	...2x1	...2x2	...2x3	...3x1	...3x2	...3x3
Gallery/Bridge W1 96w (40)	...96...	6873	7512	8172	7260	7842	7979	7479	8132	8731	
Gallery/Bridge W1 104w (48)	...104...	8465	9556	10349	8860	9831	10824	9435	10428	11083	

! Notes:

Determine product number by merging Prefix, Width and Matrix Codes; reference the price. Ex: PZG4W961X1 = \$6873.
Order Gallery Top and Backsplash separately and tag to your selection here.

+ Options/Parametrics:

Width range: 92-104; specify as Width Code and use next larger standard size for pricing; bridge top must be 56-in less.

Gallery Surround Panels
Polished Acrylic Solid Surface
Unframed

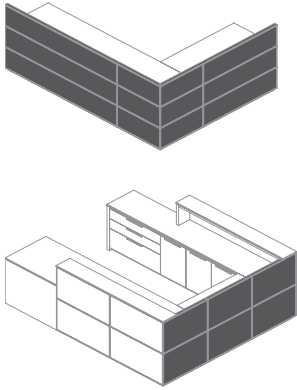

	Prefix Code/Width Code:	Matrix Code:		
2d 43.8h	PZG1C...	...1x1	...1x2	...1x3
Gallery/Surround CW 21w	...21...	6246	6807	8002
Gallery/Surround CW 24w	...24...	6547	7111	8321
Gallery/Surround CW 28w	...28...	6878	7439	8638
Gallery/Surround CW 32w	...32...	7178	7741	8942
Gallery/Surround CW 36w	...36...	7481	8042	9252
Gallery/Surround CW 40w	...40...	7758	8321	9517
Gallery/Surround CW 44w	...44...	8036	8598	9802
Gallery/Surround CW 48w	...48...	8315	8877	10087
Gallery/Surround CW 52w	...52...	8592	9152	10351
Gallery/Surround CW 56w	...56...	8968	9530	10735
Gallery/Surround CW 60w	...60...	9273	9835	11044
Gallery/Surround CW 64w	...64...	9571	10134	11326
Gallery/Surround CW 68w	...68...	9866	10428	11631
Gallery/Surround CW 72w	...72...	10165	10735	11923
Gallery/Surround CW 76w	...76...	10475	11044	12241
Gallery/Surround CW 80w	...80...	10768	11336	12537
Gallery/Surround CW 84w	...84...	11064	11631	12822
Gallery/Surround CW 88w	...88...	11360	11929	13126
Gallery/Surround CW 92w	...92...	11658	12229	13431
Gallery/Surround CW 96w	...96...	11956	12523	13714
Gallery/Surround CW 100w	...100...	12251	12822	14018
Gallery/Surround CW 104w	...104...	12969	13569	14820
Gallery/Surround CW 108w	...108...	13265	13865	15123
Gallery/Surround CW 112w	...112...	13585	14182	15446
Gallery/Surround CW 116w	...116...	13880	14482	15731
Gallery/Surround CW 120w	...120...	14173	14772	16027
Gallery/Surround CW 124w	...124...	14467	15069	16333

! Notes:
 Determine product number by merging Prefix, Width and Matrix Codes; reference the price. Ex: PZG1C211X1 = \$6246.
 Polished Acrylic Solid Surface selection is Avonite® Polaris. Other selections available on a request basis.
 + Options/Parametrics:
 Width range: 8-124; specify as Width Code and use next larger standard size for pricing.



Polished Acrylic Solid Surface: Avonite® Polaris, unframed.
 Other vendor colors and patterns are available on a project basis; contact Customer Service.

Galleries for Desks & Credenzas
Polished Acrylic Solid Surface
Unframed

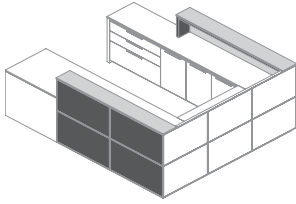

		Prefix Code/Width Code:		Matrix Code:								
10.8d	43.8h	PZG2C...	...1x1	...1x2	...1x3	...2x1	...2x2	...2x3	...3x1	...3x2	...3x3	
Gallery/DeskCred CW 76w	...76...	14369	15120	16996	15083	16550	18348	15820	18107	20490		
Gallery/DeskCred CW 80w	...80...	14658	15411	17297	15374	16826	18625	16059	18348	20707		
Gallery/DeskCred CW 84w	...84...	14950	15703	17573	15664	17131	18903	16279	18586	20924		
Gallery/DeskCred CW 88w	...88...	15280	16034	17911	15994	17449	19261	16735	19023	21421		
Gallery/DeskCred CW 92w	...92...	15569	16322	18209	16283	17750	19536	16953	19261	21638		
Gallery/DeskCred CW 96w	...96...	15870	16622	18492	16584	18037	19821	17197	19504	21863		
Gallery/DeskCred CW 100w	...100...	16158	16913	18789	16872	18342	20099	17613	19900	22261		
Gallery/DeskCred CW 104w	...104...	16866	17654	19584	17454	19174	21289	18107	20655	22953		
Gallery/DeskCred CW 108w	...108...	17157	17945	19882	17747	19450	21564	18348	20892	23232		
Gallery/DeskCred CW 112w	...112...	17486	18274	20217	18075	19795	21922	18803	21330	23668		
Gallery/DeskCred CW 116w	...116...	17784	18571	20501	18376	20079	22208	19028	21572	23893		
Gallery/DeskCred CW 120w	...120...	18118	18903	20840	18706	20423	22527	19305	21853	24151		
Gallery/DeskCred CW 124w	...124...	18408	19196	21139	18996	20699	22843	19722	22244	24607		

- ! Notes:
Determine product number by merging Prefix, Width and Matrix Codes; reference the price. Ex: PZG2C761X1= \$14369.
Order Gallery Top separately and tag to your selection here.
Designate placement of Gallery on Desk or Credenza as user's Left, Center or Right.
Polished Acrylic Solid Surface selection is Avonite® Polaris. Other selections available on a request basis.
- + Options/Parametrics:
Width range: 60-124; specify as Width Code and use next larger standard size for pricing.

Galleries for Runoffs
Polished Acrylic Solid Surface
Unframed

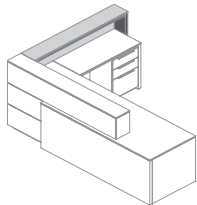

		Prefix Code/Width Code:		Matrix Code:								
10.8d	43.8h	PZG3C...	...1x1	...1x2	...1x3	...2x1	...2x2	...2x3	...3x1	...3x2	...3x3	
Gallery/Runoff CW 40w LH	...40L...	9898	10433	11876	10607	11849	13223	11348	13424	15365		
Gallery/Runoff CW 40w RH	...40R...	9898	10433	11876	10607	11849	13223	11348	13424	15365		
Gallery/Runoff CW 48w LH	...48L...	10488	11021	12478	11195	12437	13787	11809	13907	15810		
Gallery/Runoff CW 48w RH	...48R...	10488	11021	12478	11195	12437	13787	11809	13907	15810		
Gallery/Runoff CW 56w LH	...56L...	11069	11603	13052	11776	13019	14382	12462	14539	16484		
Gallery/Runoff CW 56w RH	...56R...	11069	11603	13052	11776	13019	14382	12462	14539	16484		
Gallery/Runoff CW 64w LH	...64L...	11658	12196	13634	12365	13605	14984	13106	15181	17103		
Gallery/Runoff CW 64w RH	...64R...	11658	12196	13634	12365	13605	14984	13106	15181	17103		
Gallery/Runoff CW 72w LH	...72L...	12271	12815	14247	12985	14231	15576	13602	15698	17639		
Gallery/Runoff CW 72w RH	...72R...	12271	12815	14247	12985	14231	15576	13602	15698	17639		
Gallery/Runoff CW 80w LH	...80L...	12854	13396	14845	13567	14810	16173	14254	16331	18254		
Gallery/Runoff CW 80w RH	...80R...	12854	13396	14845	13567	14810	16173	14254	16331	18254		
Gallery/Runoff CW 88w LH	...88L...	13442	13984	15425	14155	15398	16773	14894	16969	18934		
Gallery/Runoff CW 88w RH	...88R...	13442	13984	15425	14155	15398	16773	14894	16969	18934		
Gallery/Runoff CW 96w LH	...96L...	14025	14565	16001	14739	15981	17328	15352	17449	19371		
Gallery/Runoff CW 96w RH	...96R...	14025	14565	16001	14739	15981	17328	15352	17449	19371		

- ! Notes:
Determine product number by merging Prefix, Width and Matrix Codes; reference the price. Ex: PZG3C40L1X1= \$9898.
Order Gallery Top separately and tag to your selection here.
Polished Acrylic Solid Surface selection is Avonite® Polaris. Other selections available on a request basis.
- + Options/Parametrics:
Width range: 32-96; specify as Width Code and use next larger standard size for pricing.

Galleries for Bridges
Polished Acrylic Solid Surface
Unframed

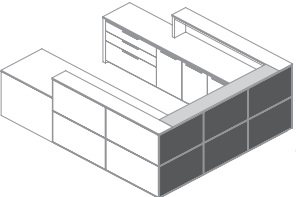

		Prefix Code/Width Code:		Matrix Code:								
10.8d	43.8h	PZG4C...	...1x1	...1x2	...1x3	...2x1	...2x2	...2x3	...3x1	...3x2	...3x3	
Gallery/Bridge CW 96w (40)	...96...	11183	11480	12419	12024	12788	13370	12598	14242	15789		
Gallery/Bridge CW 104w (48)	...104...	14947	15485	16921	15660	16887	18248	16274	18368	20310		

- ! Notes:
Determine product number by merging Prefix, Width and Matrix Codes; reference the price. Ex: PZG4C961X1= \$11183.
Order Gallery Top separately and tag to your selection here.
Polished Acrylic Solid Surface selection is Avonite® Polaris. Other selections available on a request basis.
- + Options/Parametrics:
Width range: 92-104; specify as Width Code and use next larger standard size for pricing; bridge top must be 56-in less.



Specify: Product Number
Quantity
Color/Finish
Tagging

‡ Requires field sub-assembly.

Gallery Surround Panels
3Form® Reflect
Unframed

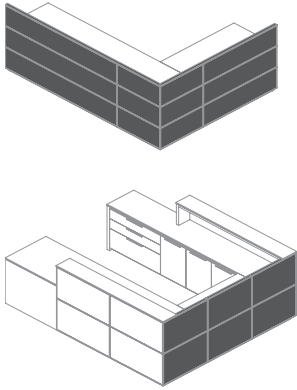

2d 43.8h	Prefix Code/Width Code:		Matrix Code:		
	PZG1F...	...1x1	...1x2	...1x3	
Gallery/Surround FR 21w	...21...	7683	8539	9312	
Gallery/Surround FR 24w	...24...	8459	9306	10087	
Gallery/Surround FR 28w	...28...	9412	10257	11038	
Gallery/Surround FR 32w	...32...	10330	11175	11956	
Gallery/Surround FR 36w	...36...	11249	12100	12881	
Gallery/Surround FR 40w	...40...	12146	13000	13780	
Gallery/Surround FR 44w	...44...	13047	13900	14678	
Gallery/Surround FR 48w	...48...	13941	14798	15576	
Gallery/Surround FR 52w	...52...	14839	15683	16478	
Gallery/Surround FR 56w	...56...	15837	16681	17476	
Gallery/Surround FR 60w	...60...	16762	17607	18381	
Gallery/Surround FR 64w	...64...	17675	18525	19301	
Gallery/Surround FR 68w	...68...	18592	19447	20217	
Gallery/Surround FR 72w	...72...	19518	20372	21144	
Gallery/Surround FR 76w	...76...	20441	21303	22074	
Gallery/Surround FR 80w	...80...	21357	22202	22989	
Gallery/Surround FR 84w	...84...	22274	23120	23906	
Gallery/Surround FR 88w	...88...	23186	24038	24826	
Gallery/Surround FR 92w	...92...	24105	24956	25744	

! Notes:
Determine product number by merging Prefix, Width and Matrix Codes; reference the price. Ex: PZG1F211X1= \$7683.
+ Options/Parameters:
Width range: 8-92; specify as Width Code and use next larger standard size for pricing.



3Form® Reflect, unframed.
Other vendor colors and patterns are available on a project basis; contact Customer Service.

Galleries for Desks & Credenzas
3Form® Reflect
Unframed

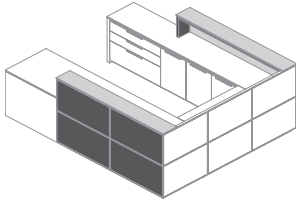

		Prefix Code/Width Code:		Matrix Code:								
10.8d	43.8h	PZG2F...	...1x1	...1x2	...1x3	...2x1	...2x2	...2x3	...3x1	...3x2	...3x3	
Gallery/DeskCred FR 76w	...76...	25637	25880	26099	25710	25936	26161	25983	26212	26438		
Gallery/DeskCred FR 80w	...80...	26550	26782	27013	26608	26849	27071	26675	26886	27131		
Gallery/DeskCred FR 84w	...84...	27462	27694	27924	27524	27761	27985	27369	27601	27829		
Gallery/DeskCred FR 88w	...88...	28408	28647	28877	28476	28712	28937	28739	28988	29212		
Gallery/DeskCred FR 92w	...92...	29319	29558	29790	29385	29624	29848	29434	29665	29910		
Gallery/DeskCred FR 96w	...96...	30241	30476	30707	30305	30542	30728	30132	30382	30609		
Gallery/DeskCred FR 100w	...100...	-	-	-	31217	31454	31639	31481	31732	31957		
Gallery/DeskCred FR 104w	...104...	-	-	-	32168	32473	32710	32255	32564	32832		
Gallery/DeskCred FR 108w	...108...	-	-	-	33080	33385	33623	32949	33278	33521		
Gallery/DeskCred FR 112w	...112...	-	-	-	34033	34338	34574	34338	34629	34911		
Gallery/DeskCred FR 116w	...116...	-	-	-	34952	35229	35492	35039	35348	35614		
Gallery/DeskCred FR 120w	...120...	-	-	-	35904	36180	36448	35771	36063	36347		
Gallery/DeskCred FR 124w	...124...	-	-	-	36815	37093	37360	37098	37408	37696		

! Notes:
Determine product number by merging Prefix, Width and Matrix Codes; reference the price. Ex: PZG2F761X1= \$25637.
Order Gallery Top separately and tag to your selection here.
Designate placement of Gallery on Desk or Credenza as user's Left, Center or Right.

+ Options/Parametrics:
Width range: 60-124; specify as Width Code and use next larger standard size for pricing.

Galleries for Runoffs
3Form® Reflect
Unframed

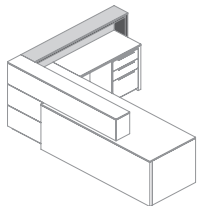

		Prefix Code/Width Code:		Matrix Code:								
10.8d	43.8h	PZG3F...	...1x1	...1x2	...1x3	...2x1	...2x2	...2x3	...3x1	...3x2	...3x3	
Gallery/Runoff FR 40w LH	...40L...	14923	15073	15228	14989	15140	15268	15268	15391	15542		
Gallery/Runoff FR 40w RH	...40R...	14923	15073	15228	14989	15140	15268	15268	15391	15542		
Gallery/Runoff FR 48w LH	...48L...	16745	16905	17058	16821	16969	17098	16641	16787	16939		
Gallery/Runoff FR 48w RH	...48R...	16745	16905	17058	16821	16969	17098	16641	16787	16939		
Gallery/Runoff FR 56w LH	...56L...	18571	18716	18882	18630	18798	18923	18685	18848	18981		
Gallery/Runoff FR 56w RH	...56R...	18571	18716	18882	18630	18798	18923	18685	18848	18981		
Gallery/Runoff FR 64w LH	...64L...	20395	20549	20694	20462	20600	20752	20733	20878	21032		
Gallery/Runoff FR 64w RH	...64R...	20395	20549	20694	20462	20600	20752	20733	20878	21032		
Gallery/Runoff FR 72w LH	...72L...	22261	22412	22559	22325	22466	22618	22162	22305	22458		
Gallery/Runoff FR 72w RH	...72R...	22261	22412	22559	22325	22466	22618	22162	22305	22458		
Gallery/Runoff FR 80w LH	...80L...	24079	24225	24382	24138	24288	24443	24205	24332	24502		
Gallery/Runoff FR 80w RH	...80R...	24079	24225	24382	24138	24288	24443	24205	24332	24502		
Gallery/Runoff FR 88w LH	...88L...	25902	26055	26212	25969	26120	26274	26233	26398	26550		
Gallery/Runoff FR 88w RH	...88R...	25902	26055	26212	25969	26120	26274	26233	26398	26550		
Gallery/Runoff FR 96w LH	...96L...	27726	27879	28036	27791	27945	28059	27621	27785	27939		
Gallery/Runoff FR 96w RH	...96R...	27726	27879	28036	27791	27945	28059	27621	27785	27939		

! Notes:
Determine product number by merging Prefix, Width and Matrix Codes; reference the price. Ex: PZG3F40L1X1= \$14923.
Order Gallery Top separately and tag to your selection here.

+ Options/Parametrics:
Width range: 32-96; specify as Width Code and use next larger standard size for pricing.

Galleries for Bridges
3Form® Reflect
Unframed

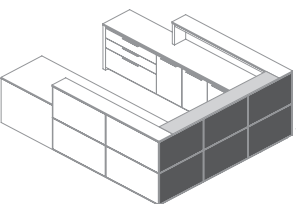

		Prefix Code/Width Code:		Matrix Code:								
10.8d	43.8h	PZG4F...	...1x1	...1x2	...1x3	...2x1	...2x2	...2x3	...3x1	...3x2	...3x3	
Gallery/Bridge FR 96w (40)	...96...	25214	25283	25365	25280	25349	25388	25110	25191	25267		
Gallery/Bridge FR 104w (48)	...104...	-	-	-	30566	30791	30953	30436	30684	30854		

! Notes:
Determine product number by merging Prefix, Width and Matrix Codes; reference the price. Ex: PZG4F961X1= \$25214.
Order Gallery Top separately and tag to your selection here.

+ Options/Parametrics:
Width range: 92-104; specify as Width Code and use next larger standard size for pricing; bridge top must be 56-in less.

Specify: Product Number
Quantity
Color/Finish
Tagging

‡ Requires field sub-assembly.

Gallery Surround Panels
Carrara Marble
Unframed

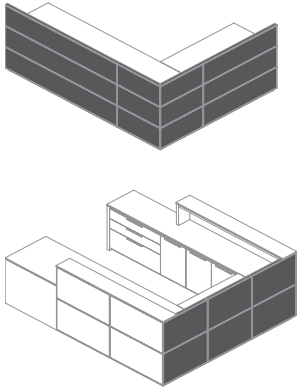

2d 43.8h	Prefix Code/Width Code:		Matrix Code:		
	PZG1S...1x1	...1x2	...1x3
Gallery/Surround SC 21w	...21...		6655	6979	7348
Gallery/Surround SC 24w	...24...		7303	7626	8002
Gallery/Surround SC 28w	...28...		8089	8407	8796
Gallery/Surround SC 32w	...32...		8842	9167	9537
Gallery/Surround SC 36w	...36...		9596	9919	10304
Gallery/Surround SC 40w	...40...		10330	10661	11026
Gallery/Surround SC 44w	...44...		11064	11387	11764
Gallery/Surround SC 48w	...48...		11799	12114	12503
Gallery/Surround SC 52w	...52...		12523	12855	13227
Gallery/Surround SC 56w	...56...		13357	13683	14064
Gallery/Surround SC 60w	...60...		14118	14434	14812
Gallery/Surround SC 64w	...64...		14869	15196	15572
Gallery/Surround SC 68w	...68...		15619	15941	16314
Gallery/Surround SC 72w	...72...		16379	16710	17076
Gallery/Surround SC 76w	...76...		17144	17470	17852
Gallery/Surround SC 80w	...80...		17892	18210	18587
Gallery/Surround SC 84w	...84...		18638	18967	19346
Gallery/Surround SC 88w	...88...		19392	19715	20085
Gallery/Surround SC 92w	...92...		20146	20463	20847
Gallery/Surround SC 96w	...96...		20902	21223	21606

- ! Notes:
 Determine product number by merging Prefix, Width and Matrix Codes; reference the price. Ex: PZG1S211X1= \$6655.
 Inquire with Customer Service for customer-supplied stone.
- + Options/Parametrics:
 Width range: 8-96; specify as Width Code and specify as Width Code and use next larger standard size for pricing.



Carrara Marble, unframed.
 Inquire with Customer Service about using customer-supplied stone.

Galleries for Desks & Credenzas
Carrara Marble
Unframed

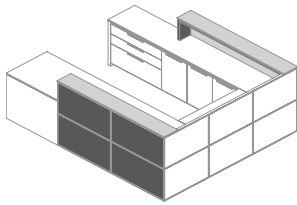

Prefix Code/Width Code:		Matrix Code:									
10.8d	43.8h	PZG2S...	...1x1	...1x2	...1x3	...2x1	...2x2	...2x3	...3x1	...3x2	...3x3
Gallery/DeskCred SC 76w	...76...	22340	22814	23207	22527	23025	23384	23073	23583	23958	
Gallery/DeskCred SC 80w	...80...	23086	23556	23938	23266	23780	24138	23649	24138	24534	
Gallery/DeskCred SC 84w	...84...	23828	24310	24692	24021	24509	24889	24205	24735	25110	
Gallery/DeskCred SC 88w	...88...	24614	25091	25467	24800	25301	25685	25354	25843	26201	
Gallery/DeskCred SC 92w	...92...	25358	25831	26220	25537	26055	26398	25929	26438	26775	
Gallery/DeskCred SC 96w	...96...	26116	26588	26981	26299	26786	27159	26490	27000	27356	
Gallery/DeskCred SC 100w	...100...	-	-	-	27040	27544	27911	27601	28111	28467	
Gallery/DeskCred SC 104w	...104...	-	-	-	27950	28615	29141	28416	29181	29755	
Gallery/DeskCred SC 108w	...108...	-	-	-	28705	29366	29896	28988	29735	30332	
Gallery/DeskCred SC 112w	...112...	-	-	-	29485	30160	30689	30120	30888	31481	
Gallery/DeskCred SC 116w	...116...	-	-	-	30231	30891	31449	30701	31449	32063	
Gallery/DeskCred SC 120w	...120...	-	-	-	31024	31687	32241	31297	32045	32676	
Gallery/DeskCred SC 124w	...124...	-	-	-	31765	32440	32955	32407	33153	33791	

! Notes:
Determine product number by merging Prefix, Width and Matrix Codes; reference the price. Ex: PZG2S761X1= \$22340.
Order Gallery Top separately and tag to your selection here.
Designate placement of Gallery on Desk or Credenza as user's Left, Center or Right.
Inquire with Customer Service for customer-supplied stone.

+ Options/Parametrics:
Width range: 60-124; specify as Width Code and specify as Width Code and use next larger standard size for pricing.

Galleries for Runoffs
Carrara Marble
Unframed

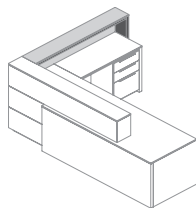

Prefix Code/Width Code:		Matrix Code:									
10.8d	43.8h	PZG3S...	...1x1	...1x2	...1x3	...2x1	...2x2	...2x3	...3x1	...3x2	...3x3
Gallery/Runoff SC 40w LH	...40L...	13312	13645	13936	13501	13859	14138	14050	14412	14694	
Gallery/Runoff SC 40w RH	...40R...	13312	13645	13936	13501	13859	14138	14050	14412	14694	
Gallery/Runoff SC 48w LH	...48L...	14810	15134	15453	14989	15345	15649	15187	15532	15850	
Gallery/Runoff SC 48w RH	...48R...	14810	15134	15453	14989	15345	15649	15187	15532	15850	
Gallery/Runoff SC 56w LH	...56L...	16299	16629	16939	16484	16826	17119	16855	17197	17476	
Gallery/Runoff SC 56w RH	...56R...	16299	16629	16939	16484	16826	17119	16855	17197	17476	
Gallery/Runoff SC 64w LH	...64L...	17799	18129	18432	17982	18342	18630	18525	18870	19168	
Gallery/Runoff SC 64w RH	...64R...	17799	18129	18432	17982	18342	18630	18525	18870	19168	
Gallery/Runoff SC 72w LH	...72L...	19325	19661	19957	19516	19859	20136	19714	20060	20357	
Gallery/Runoff SC 72w RH	...72R...	19325	19661	19957	19516	19859	20136	19714	20060	20357	
Gallery/Runoff SC 80w LH	...80L...	20817	21142	21447	20999	21368	21646	21380	21726	22043	
Gallery/Runoff SC 80w RH	...80R...	20817	21142	21447	20999	21368	21646	21380	21726	22043	
Gallery/Runoff SC 88w LH	...88L...	22313	22642	22943	22499	22854	23159	23054	23396	23674	
Gallery/Runoff SC 88w RH	...88R...	22313	22642	22943	22499	22854	23159	23054	23396	23674	
Gallery/Runoff SC 96w LH	...96L...	23806	24138	24447	23991	24336	24627	24184	24547	24824	
Gallery/Runoff SC 96w RH	...96R...	23806	24138	24447	23991	24336	24627	24184	24547	24824	

! Notes:
Determine product number by merging Prefix, Width and Matrix Codes; reference the price. Ex: PZG3S40L1X1= \$13312.
Order Gallery Top separately and tag to your selection here.
Inquire with Customer Service for customer-supplied stone.

+ Options/Parametrics:
Width range: 32-96; specify as Width Code and specify as Width Code and use next larger standard size for pricing.

Galleries for Bridges
Carrara Marble
Unframed

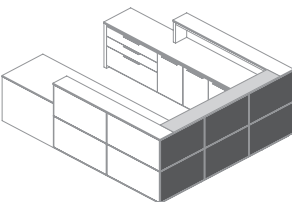

Prefix Code/Width Code:		Matrix Code:									
10.8d	43.8h	PZG4S...	...1x1	...1x2	...1x3	...2x1	...2x2	...2x3	...3x1	...3x2	...3x3
Gallery/Bridge SC 96w (40)	...96...	21497	21686	21917	21687	21883	22094	21878	22095	22294	
Gallery/Bridge SC 104w (48)	...104...	-	-	-	27926	28440	28917	28393	28997	29530	

! Notes:
Determine product number by merging Prefix, Width and Matrix Codes; reference the price. Ex: PZG4S961X1= \$21497.
Order Gallery Top separately and tag to your selection here.
Inquire with Customer Service for customer-supplied stone.

+ Options/Parametrics:
Width range: 92-104; specify as Width Code and use next larger standard size for pricing; bridge top must be 56-in less.

Gallery Surround Panels
Satin Brushed Nickel
Uncaptured Frame

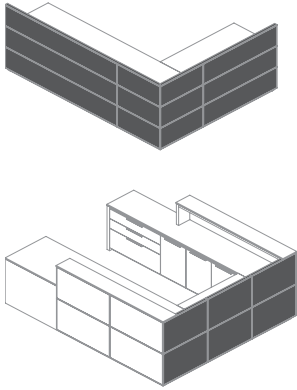

2d 43.8h	Prefix Code/Width Code:		Matrix Code:		
	PZG1BN...1x1	...1x2	...1x3
Gallery/Surround BN 21w	...21...		4499	5934	6634
Gallery/Surround BN 24w	...24...		4758	6224	6932
Gallery/Surround BN 28w	...28...		5017	6517	7287
Gallery/Surround BN 32w	...32...		5247	6788	7574
Gallery/Surround BN 36w	...36...		5484	7064	7886
Gallery/Surround BN 40w	...40...		5690	7287	8189
Gallery/Surround BN 44w	...44...		5900	7541	8454
Gallery/Surround BN 48w	...48...		6112	7792	8736
Gallery/Surround BN 52w	...52...		6318	8028	9022
Gallery/Surround BN 56w	...56...		6630	8381	9403
Gallery/Surround BN 60w	...60...		6859	8659	9715
Gallery/Surround BN 64w	...64...		7083	8913	10021
Gallery/Surround BN 68w	...68...		7315	9185	10325
Gallery/Surround BN 72w	...72...		7553	9464	10633
Gallery/Surround BN 76w	...76...		7792	9735	10950
Gallery/Surround BN 80w	...80...		8017	9999	11249
Gallery/Surround BN 84w	...84...		8249	10270	11554
Gallery/Surround BN 88w	...88...		8471	10528	11857
Gallery/Surround BN 92w	...92...		8703	10801	12141
Gallery/Surround BN 96w	...96...		8934	11071	12465

- ! Notes:
- Determine product number by merging Prefix, Width and Matrix Codes; reference the price. Ex: PZG1BN211X1= \$4499.
- + Options/Parametrics:
- Width range: 8-96; specify as Width Code and use next larger standard size for pricing.

Uncaptured frames
have no lip.



MSBN Satin Brushed Nickel, captured in an extruded MRBAS aluminum frame.

Galleries for Desks & Credenzas
Satin Brushed Nickel
Uncaptured Frame

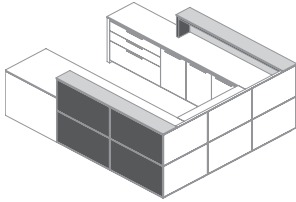

		Prefix Code/Width Code:		Matrix Code:								
10.8d	43.8h	PZG2BN...	...1x1	...1x2	...1x3	...2x1	...2x2	...2x3	...3x1	...3x2	...3x3	
Gallery/DeskCred BN 76w	...76...	10685	13044	15374	11536	13455	15134	12462	14632	16939		
Gallery/DeskCred BN 80w	...80...	10873	13312	15670	11764	13707	15453	12641	14790	17157		
Gallery/DeskCred BN 84w	...84...	11095	13573	15966	11989	13960	15691	12821	14989	17435		
Gallery/DeskCred BN 88w	...88...	10093	13865	16307	12250	14247	16048	13176	15425	17812		
Gallery/DeskCred BN 92w	...92...	10317	14130	16601	12478	14527	16363	13337	15626	18089		
Gallery/DeskCred BN 96w	...96...	10500	14386	16905	12710	14783	16648	13540	15828	18314		
Gallery/DeskCred BN 100w	...100...	-	-	-	12920	15061	16966	13820	16186	18709		
Gallery/DeskCred BN 104w	...104...	-	-	-	13210	15446	17483	14138	16584	18690		
Gallery/DeskCred BN 108w	...108...	-	-	-	13435	15776	17718	14315	16821	18967		
Gallery/DeskCred BN 112w	...112...	-	-	-	13699	16014	18075	14651	17258	19464		
Gallery/DeskCred BN 116w	...116...	-	-	-	13931	16274	18397	14855	17421	19691		
Gallery/DeskCred BN 120w	...120...	-	-	-	14198	16589	18716	15055	17662	19947		
Gallery/DeskCred BN 124w	...124...	-	-	-	14407	16839	19033	15374	18057	20342		

! Notes:
Determine product number by merging Prefix, Width and Matrix Codes; reference the price. Ex: PZG2BN761X1= \$10685.
Order Gallery Top separately and tag to your selection here.
Designate placement of Gallery on Desk or Credenza as user's Left, Center or Right.

+ Options/Parametrics:
Width range: 60-124; specify as Width Code and use next larger standard size for pricing.

Galleries for Runoffs
Satin Brushed Nickel
Uncaptured Frame

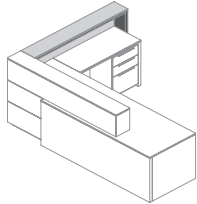

		Prefix Code/Width Code:		Matrix Code:								
10.8d	43.8h	PZG3BN...	...1x1	...1x2	...1x3	...2x1	...2x2	...2x3	...3x1	...3x2	...3x3	
Gallery/Runoff BN 40w LH	...40L...	7678	9088	10706	8543	9893	11021	9451	11069	12848		
Gallery/Runoff BN 40w RH	...40R...	7678	9088	10706	8543	9893	11021	9451	11069	12848		
Gallery/Runoff BN 48w LH	...48L...	8129	9621	11307	9001	10428	11625	9813	11432	13350		
Gallery/Runoff BN 48w RH	...48R...	8129	9621	11307	9001	10428	11625	9813	11432	13350		
Gallery/Runoff BN 56w LH	...56L...	8571	10137	11883	9424	10932	12261	10290	12067	13964		
Gallery/Runoff BN 56w RH	...56R...	8571	10137	11883	9424	10932	12261	10290	12067	13964		
Gallery/Runoff BN 64w LH	...64L...	9022	10660	12503	9878	11465	12821	10813	12630	14644		
Gallery/Runoff BN 64w RH	...64R...	9022	10660	12503	9878	11465	12821	10813	12630	14644		
Gallery/Runoff BN 72w LH	...72L...	9509	11229	13119	10367	12034	13455	11209	13066	15120		
Gallery/Runoff BN 72w RH	...72R...	9509	11229	13119	10367	12034	13455	11209	13066	15120		
Gallery/Runoff BN 80w LH	...80L...	9952	11744	13712	10806	12536	14092	11683	13623	15796		
Gallery/Runoff BN 80w RH	...80R...	9952	11744	13712	10806	12536	14092	11683	13623	15796		
Gallery/Runoff BN 88w LH	...88L...	9179	12266	14337	11259	13044	14651	12184	14221	16416		
Gallery/Runoff BN 88w RH	...88R...	9179	12266	14337	11259	13044	14651	12184	14221	16416		
Gallery/Runoff BN 96w LH	...96L...	9550	12793	14913	11711	13573	15248	12542	14620	16913		
Gallery/Runoff BN 96w RH	...96R...	9550	12793	14913	11711	13573	15248	12542	14620	16913		

! Notes:
Determine product number by merging Prefix, Width and Matrix Codes; reference the price. Ex: PZG3BN40L1X1= \$7678.
Order Gallery Top separately and tag to your selection here.

+ Options/Parametrics:
Width range: 32-96; specify as Width Code and use next larger standard size for pricing.

Galleries for Bridges
Satin Brushed Nickel
Uncaptured Frame

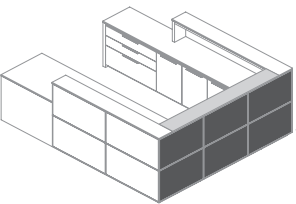

		Prefix Code/Width Code:		Matrix Code:								
10.8d	43.8h	PZG4BN...	...1x1	...1x2	...1x3	...2x1	...2x2	...2x3	...3x1	...3x2	...3x3	
Gallery/Bridge BN 96w (40)	...96...	8189	10671	12300	10201	11778	13187	10997	12770	14772		
Gallery/Bridge BN 104w (48)	...104...	-	-	-	11843	13875	15541	12684	14866	16731		

! Notes:
Determine product number by merging Prefix, Width and Matrix Codes; reference the price. Ex: PZG4BN961X1= \$8189.
Order Gallery Top separately and tag to your selection here.

+ Options/Parametrics:
Width range: 92-104; specify as Width Code and use next larger standard size for pricing; bridge top must be 56-in less.

Specify: Product Number
Quantity
Color/Finish
Tagging

‡ Requires field sub-assembly.

Gallery Surround Panels
 Silix Faux Leather
 Unframed

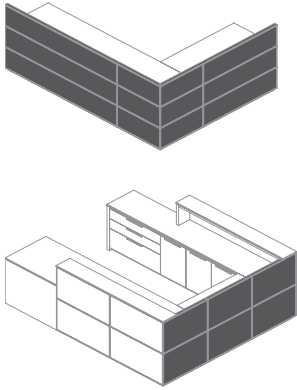

2d 43.8h	Prefix Code/Width Code:		Matrix Code:		
	PZG1P...		...1x1	...1x2	...1x3
Gallery/Surround PR 21w	...21...		4376	5062	6041
Gallery/Surround PR 24w	...24...		4637	5328	6295
Gallery/Surround PR 28w	...28...		4910	5589	6574
Gallery/Surround PR 32w	...32...		5146	5834	6802
Gallery/Surround PR 36w	...36...		5393	6075	7052
Gallery/Surround PR 40w	...40...		5609	6284	7277
Gallery/Surround PR 44w	...44...		5821	6507	7481
Gallery/Surround PR 48w	...48...		6041	6722	7706
Gallery/Surround PR 52w	...52...		6256	6946	7929
Gallery/Surround PR 56w	...56...		6574	7254	8234
Gallery/Surround PR 60w	...60...		6820	7505	8485
Gallery/Surround PR 64w	...64...		7058	7741	8709
Gallery/Surround PR 68w	...68...		7295	7985	8953
Gallery/Surround PR 72w	...72...		7541	8220	9206
Gallery/Surround PR 76w	...76...		7784	8465	9444
Gallery/Surround PR 80w	...80...		8017	8703	9682
Gallery/Surround PR 84w	...84...		8254	8934	9927
Gallery/Surround PR 88w	...88...		8491	9179	10151
Gallery/Surround PR 92w	...92...		8731	9412	10395
Gallery/Surround PR 96w	...96...		8968	9655	10620
Gallery/Surround PR 100w	...100...		9206	9888	10865
Gallery/Surround PR 104w	...104...		9637	10607	11883
Gallery/Surround PR 108w	...108...		9872	10841	12108
Gallery/Surround PR 112w	...112...		10126	11092	12372
Gallery/Surround PR 116w	...116...		10361	11336	12598
Gallery/Surround PR 120w	...120...		10596	11561	12834
Gallery/Surround PR 124w	...124...		10832	11806	13079

! Notes:

Determine product number by merging Prefix, Width and Matrix Codes; reference the price. Ex: PZG1P211X1= \$4376.

+ Options/Parametrics:

Width range: 8-124; specify as Width Code and use next larger standard size for pricing.



TUOHY Silix Faux Leather, unframed

Available in 19 standard colors. Inquire regarding use of COM fabrics suitable for vertical application.

Galleries for Desks & Credenzas
Silex Faux Leather
Unframed

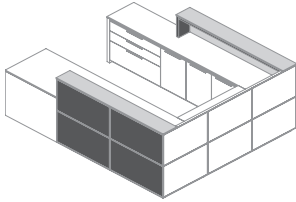

		Prefix Code/Width Code:		Matrix Code:								
10.8d	43.8h	PZG2P...	...1x1	...1x2	...1x3	...2x1	...2x2	...2x3	...3x1	...3x2	...3x3	
Gallery/DeskCred PR 76w	...76...	10752	11603	12753	11114	11842	12637	11536	12344	13152		
Gallery/DeskCred PR 80w	...80...	10983	11842	12992	11341	12067	12875	11718	12503	13371		
Gallery/DeskCred PR 84w	...84...	11214	12067	13231	11565	12292	13111	11915	12703	13529		
Gallery/DeskCred PR 88w	...88...	11487	12344	13491	11842	12583	13350	12271	13059	13907		
Gallery/DeskCred PR 92w	...92...	11718	12571	13727	12067	12808	13589	12452	13256	14064		
Gallery/DeskCred PR 96w	...96...	11955	12815	13950	12310	13040	13833	12656	13424	14287		
Gallery/DeskCred PR 100w	...100...	12184	13040	14189	12536	13265	14070	12975	13739	14565		
Gallery/DeskCred PR 104w	...104...	12608	13754	15201	12975	13727	14547	13410	14176	14961		
Gallery/DeskCred PR 108w	...108...	12843	13978	15418	13210	13950	14783	13605	14337	15181		
Gallery/DeskCred PR 112w	...112...	13106	14242	15698	13475	14215	15022	13964	14732	15560		
Gallery/DeskCred PR 116w	...116...	13344	14487	15921	13719	14472	15268	14149	14894	15722		
Gallery/DeskCred PR 120w	...120...	13611	14750	16198	13984	14739	15542	14386	15134	15921		
Gallery/DeskCred PR 124w	...124...	13846	14989	16436	14221	14961	15783	14705	15453	16255		

- ! Notes:
 Determine product number by merging Prefix, Width and Matrix Codes; reference the price. Ex: PZG2P761X1= \$10752.
 Order Gallery Top separately and tag to your selection here.
 Designate placement of Gallery on Desk or Credenza as user's Left, Center or Right.
- + Options/Parametrics:
 Width range: 60-124; specify as Width Code and use next larger standard size for pricing.

Galleries for Runoffs
Silex Faux Leather
Unframed

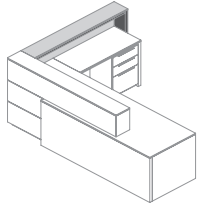

		Prefix Code/Width Code:		Matrix Code:								
10.8d	43.8h	PZG3P...	...1x1	...1x2	...1x3	...2x1	...2x2	...2x3	...3x1	...3x2	...3x3	
Gallery/Runoff PR 40w LH	...40L...	7558	8240	9239	7918	8478	9118	8354	8953	9614		
Gallery/Runoff PR 40w RH	...40R...	7558	8240	9239	7918	8478	9118	8354	8953	9614		
Gallery/Runoff PR 48w LH	...48L...	8023	8709	9701	8374	8934	9562	8715	9319	9998		
Gallery/Runoff PR 48w RH	...48R...	8023	8709	9701	8374	8934	9562	8715	9319	9998		
Gallery/Runoff PR 56w LH	...56L...	8485	9171	10158	8837	9410	10038	9232	9831	10495		
Gallery/Runoff PR 56w RH	...56R...	8485	9171	10158	8837	9410	10038	9232	9831	10495		
Gallery/Runoff PR 64w LH	...64L...	8953	9642	10619	9305	9866	10522	9735	10355	10997		
Gallery/Runoff PR 64w RH	...64R...	8953	9642	10619	9305	9866	10522	9735	10355	10997		
Gallery/Runoff PR 72w LH	...72L...	9456	10142	11135	9808	10382	10997	10150	10752	11415		
Gallery/Runoff PR 72w RH	...72R...	9456	10142	11135	9808	10382	10997	10150	10752	11415		
Gallery/Runoff PR 80w LH	...80L...	9914	10607	11592	10270	10832	11470	10645	11267	11969		
Gallery/Runoff PR 80w RH	...80R...	9914	10607	11592	10270	10832	11470	10645	11267	11969		
Gallery/Runoff PR 88w LH	...88L...	10382	11075	12054	10739	11313	11915	11170	11788	12469		
Gallery/Runoff PR 88w RH	...88R...	10382	11075	12054	10739	11313	11915	11170	11788	12469		
Gallery/Runoff PR 96w LH	...96L...	10844	11536	12509	11202	11764	12392	11545	12146	12848		
Gallery/Runoff PR 96w RH	...96R...	10844	11536	12509	11202	11764	12392	11545	12146	12848		

- ! Notes:
 Determine product number by merging Prefix, Width and Matrix Codes; reference the price. Ex: PZG3P40L1X1= \$7558.
 Order Gallery Top separately and tag to your selection here.
- + Options/Parametrics:
 Width range: 32-96; specify as Width Code and use next larger standard size for pricing.

Galleries for Bridges
Silex Faux Leather
Unframed

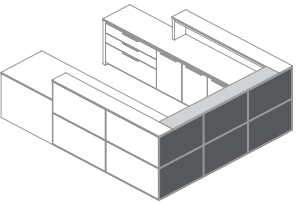

		Prefix Code/Width Code:		Matrix Code:								
10.8d	43.8h	PZG4P...	...1x1	...1x2	...1x3	...2x1	...2x2	...2x3	...3x1	...3x2	...3x3	
Gallery/Bridge PR 96w (40)	...96...	9735	10264	11068	10093	10488	10950	10434	10873	11406		
Gallery/Bridge PR 104w (48)	...104...	11731	12703	13977	12100	12677	13344	12496	13059	13739		

- ! Notes:
 Determine product number by merging Prefix, Width and Matrix Codes; reference the price. Ex: PZG4P961X1= \$9735.
 Order Gallery Top separately and tag to your selection here.
- + Options/Parametrics:
 Width range: 92-104; specify as Width Code and use next larger standard size for pricing; bridge top must be 56-in less.

Gallery Surround Panels
Back-Painted Glass
Uncaptured Frame

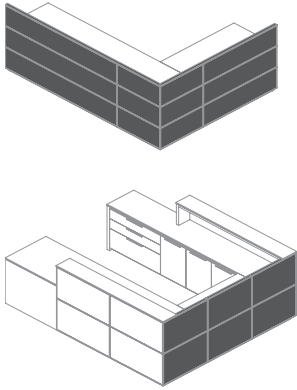

	Prefix Code/Width Code:	Matrix Code:		
2d 43.8h	PZG1GB...	...1x1	...1x2	...1x3
Gallery/Surround GB 21w	...21...	5299	7007	7487
Gallery/Surround GB 24w	...24...	5670	7398	7924
Gallery/Surround GB 28w	...28...	6078	7831	8397
Gallery/Surround GB 32w	...32...	6455	8249	8842
Gallery/Surround GB 36w	...36...	6845	8598	9312
Gallery/Surround GB 40w	...40...	7197	9056	9755
Gallery/Surround GB 44w	...44...	7560	9448	10177
Gallery/Surround GB 48w	...48...	7919	9846	10620
Gallery/Surround GB 52w	...52...	8274	10230	11044
Gallery/Surround GB 56w	...56...	8731	10726	11565
Gallery/Surround GB 60w	...60...	9121	11144	12034
Gallery/Surround GB 64w	...64...	9490	11552	12499
Gallery/Surround GB 68w	...68...	9872	11967	12943
Gallery/Surround GB 72w	...72...	10257	12392	13412
Gallery/Surround GB 76w	...76...	10647	12806	13865
Gallery/Surround GB 80w	...80...	11018	13220	14304
Gallery/Surround GB 84w	...84...	11400	13630	14765
Gallery/Surround GB 88w	...88...	-	14040	15228
Gallery/Surround GB 92w	...92...	-	14450	15670
Gallery/Surround GB 96w	...96...	-	14871	16133
Gallery/Surround GB 100w	...100...	-	-	16577

! Notes:

Determine product number by merging Prefix, Width and Matrix Codes; reference the price. Ex: PZG1GB211X1= \$5299.

+ Options/Parametrics:

Width range: 8-100; specify as Width Code and use next larger standard size for pricing.

Back-Painted Glass panels available in S.BLK Black and S.BWT White; match colors on special request.

Uncaptured frames
have no lip.

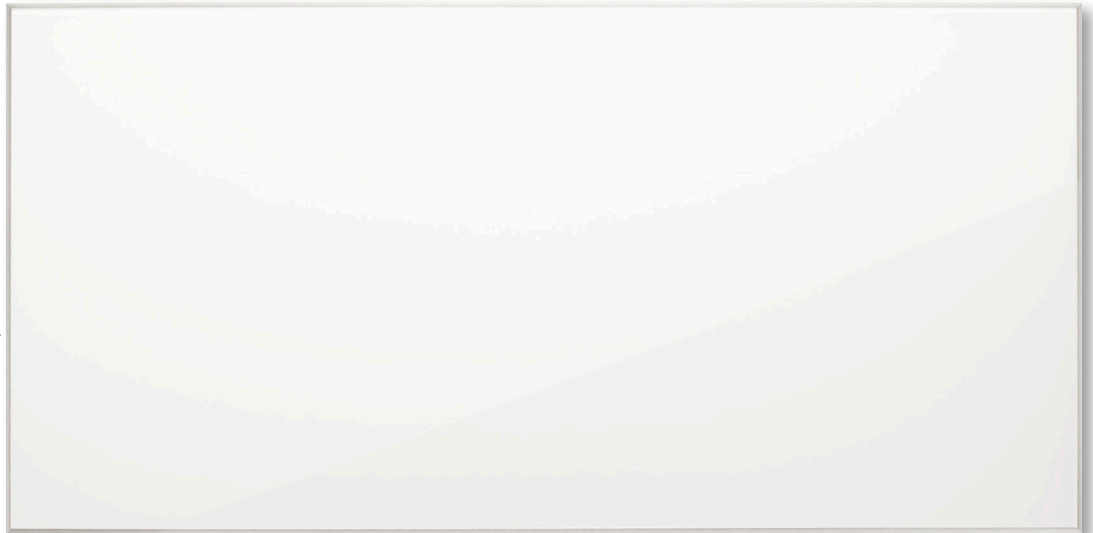

Back-Painted Glass, captured in an extruded MRBAS aluminum frame.
Customer match paint colors for the glass may also be applied; contact Customer Service.

Galleries for Desks & Credenzas
Back-Painted Glass
Uncaptured Frame

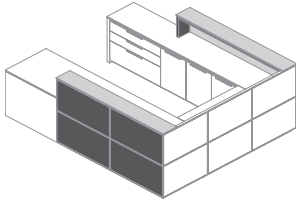

		Prefix Code/Width Code:		Matrix Code:								
10.8d	43.8h	PZG2GB...	...1x1	...1x2	...1x3	...2x1	...2x2	...2x3	...3x1	...3x2	...3x3	
Gallery/DeskCred GB 76w	...76...	...	13950	16100	18266	15002	16893	18625	16001	18135	20490	
Gallery/DeskCred GB 80w	...80...	...	14319	16510	18706	15374	17302	19062	16299	18452	20826	
Gallery/DeskCred GB 84w	...84...	...	14698	16921	19160	15755	17710	19457	16575	18733	21164	
Gallery/DeskCred GB 88w	...88...	...	-	17370	19637	16166	18162	19974	17149	19366	21835	
Gallery/DeskCred GB 92w	...92...	...	-	17778	20071	16534	18571	20408	17428	19722	22173	
Gallery/DeskCred GB 96w	...96...	...	-	18195	20535	16913	18990	20892	17733	20047	22518	
Gallery/DeskCred GB 100w	...100...	...	-	-	20990	17281	19399	21330	18248	20600	23153	
Gallery/DeskCred GB 104w	...104...	...	-	-	-	17718	19941	22003	18666	21118	23250	
Gallery/DeskCred GB 108w	...108...	...	-	-	-	18089	20429	22400	18981	21475	23649	
Gallery/DeskCred GB 112w	...112...	...	-	-	-	18513	20801	22876	19536	22107	24321	
Gallery/DeskCred GB 116w	...116...	...	-	-	-	18888	21214	23355	19843	22433	24668	
Gallery/DeskCred GB 120w	...120...	...	-	-	-	19299	21665	23834	20160	22748	25101	
Gallery/DeskCred GB 124w	...124...	...	-	-	-	19655	22100	24310	20694	23345	25677	

! Notes:
Determine product number by merging Prefix, Width and Matrix Codes; reference the price. Ex: PZG2GB761X1= \$13950.
Order Gallery Top separately and tag to your selection here.
Designate placement of Gallery on Desk or Credenza as user's Left, Center or Right.
+ Options/Parametrics:
Width range: 60-124; specify as Width Code and use next larger standard size for pricing.
Back-Painted Glass panels available in S.BLK Black and S.BWT White; match colors on special request.

Galleries for Runoffs
Back-Painted Glass
Uncaptured Frame

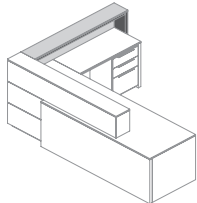

		Prefix Code/Width Code:		Matrix Code:								
10.8d	43.8h	PZG3GB...	...1x1	...1x2	...1x3	...2x1	...2x2	...2x3	...3x1	...3x2	...3x3	
Gallery/Runoff GB 40w LH	...40L...	...	9484	10898	12509	10349	11679	12848	11325	12920	14711	
Gallery/Runoff GB 40w RH	...40R...	...	9484	10898	12509	10349	11679	12848	11325	12920	14711	
Gallery/Runoff GB 48w LH	...48L...	...	10236	11723	13410	11095	12531	13766	11908	13562	15453	
Gallery/Runoff GB 48w RH	...48R...	...	10236	11723	13410	11095	12531	13766	11908	13562	15453	
Gallery/Runoff GB 56w LH	...56L...	...	10978	12542	14303	11837	13323	14677	12742	14472	16423	
Gallery/Runoff GB 56w RH	...56R...	...	10978	12542	14303	11837	13323	14677	12742	14472	16423	
Gallery/Runoff GB 64w LH	...64L...	...	11723	13356	15201	12583	14149	15519	13578	15391	17403	
Gallery/Runoff GB 64w RH	...64R...	...	11723	13356	15201	12583	14149	15519	13578	15391	17403	
Gallery/Runoff GB 72w LH	...72L...	...	12509	14231	16132	13378	15008	16469	14198	16066	18118	
Gallery/Runoff GB 72w RH	...72R...	...	12509	14231	16132	13378	15008	16469	14198	16066	18118	
Gallery/Runoff GB 80w LH	...80L...	...	13250	15035	17026	14104	15828	17382	15029	16979	19145	
Gallery/Runoff GB 80w RH	...80R...	...	13250	15035	17026	14104	15828	17382	15029	16979	19145	
Gallery/Runoff GB 88w LH	...88L...	...	-	15860	17925	14862	16655	18261	15850	17857	20126	
Gallery/Runoff GB 88w RH	...88R...	...	-	15860	17925	14862	16655	18261	15850	17857	20126	
Gallery/Runoff GB 96w LH	...96L...	...	-	16680	18816	15603	17476	19174	16423	18530	20801	
Gallery/Runoff GB 96w RH	...96R...	...	-	16680	18816	15603	17476	19174	16423	18530	20801	

! Notes:
Determine product number by merging Prefix, Width and Matrix Codes; reference the price. Ex: PZG3GB40L1X1= \$9484.
Order Gallery Top separately and tag to your selection here.
+ Options/Parametrics:
Width range: 32-96; specify as Width Code and use next larger standard size for pricing.
Back-Painted Glass panels available in S.BLK Black and S.BWT White; match colors on special request.

Galleries for Bridges
Back-Painted Glass
Uncaptured Frame

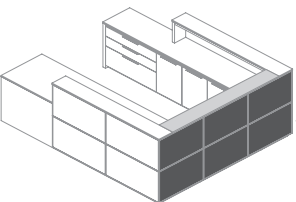

		Prefix Code/Width Code:		Matrix Code:								
10.8d	43.8h	PZG4GB...	...1x1	...1x2	...1x3	...2x1	...2x2	...2x3	...3x1	...3x2	...3x3	
Gallery/Bridge GB 96w (40)	...96...	...	-	15165	17098	14298	15962	17454	15116	17017	19081	
Gallery/Bridge GB 104w (48)	...104...	...	-	-	-	17580	19704	21638	18531	20916	22949	

! Notes:
Determine product number by merging Prefix, Width and Matrix Codes; reference the price. Ex: PZG4GB961X2= \$15165.
Order Gallery Top separately and tag to your selection here.
+ Options/Parametrics:
Width range: 92-104; specify as Width Code and use next larger standard size for pricing; bridge top must be 56-in less.
Back-Painted Glass panels available in S.BLK Black and S.BWT White; match colors on special request.



Specify: Product Number
Quantity
Color/Finish
Tagging

‡ Requires field sub-assembly.

Gallery Surround Panels
Stainless Steel Wire Mesh
Captured Frame

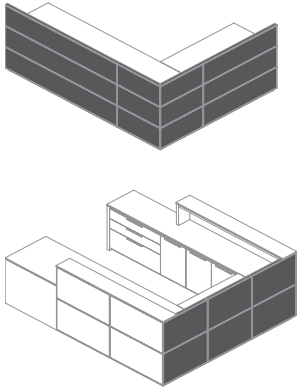

	Prefix Code/Width Code:	Matrix Code:		
2d 43.8h	PZG1WM...	...1x1	...1x2	...1x3
Gallery/Surround WM 21w	...21...	5709	7149	7825
Gallery/Surround WM 24w	...24...	6126	7586	8300
Gallery/Surround WM 28w	...28...	6595	8089	8857
Gallery/Surround WM 32w	...32...	7031	8572	9356
Gallery/Surround WM 36w	...36...	7481	9063	9888
Gallery/Surround WM 40w	...40...	7897	9496	10369
Gallery/Surround WM 44w	...44...	8315	9959	10851
Gallery/Surround WM 48w	...48...	8736	10423	11354
Gallery/Surround WM 52w	...52...	9152	10873	11857
Gallery/Surround WM 56w	...56...	9668	11432	12437
Gallery/Surround WM 60w	...60...	10118	11923	12969
Gallery/Surround WM 64w	...64...	10556	12378	13491
Gallery/Surround WM 68w	...68...	10989	12860	13992
Gallery/Surround WM 72w	...72...	11441	13350	14522
Gallery/Surround WM 76w	...76...	11890	13835	15056
Gallery/Surround WM 80w	...80...	12326	14309	15534
Gallery/Surround WM 84w	...84...	12762	14792	16055
Gallery/Surround WM 88w	...88...	13167	15248	16577
Gallery/Surround WM 92w	...92...	13569	15731	17076
Gallery/Surround WM 96w	...96...	13965	16213	17602
Gallery/Surround WM 100w	...100...	14370	16616	18005
Gallery/Surround WM 104w	...104...	14772	17021	18410
Gallery/Surround WM 108w	...108...	15168	17423	18811
Gallery/Surround WM 112w	...112...	15594	17832	19236
Gallery/Surround WM 116w	...116...	15996	18233	19617
Gallery/Surround WM 120w	...120...	16383	18633	20014
Gallery/Surround WM 124w	...124...	16787	19035	20419

! Notes:
Determine product number by merging Prefix, Width and Matrix Codes; reference the price. Ex: PZG1WM211X1= \$5709.
+ Options/Parametrics:
Width range: 8-84; specify as Width Code and use next larger standard size for pricing.

Captured frames
have a 0.19-in lip.

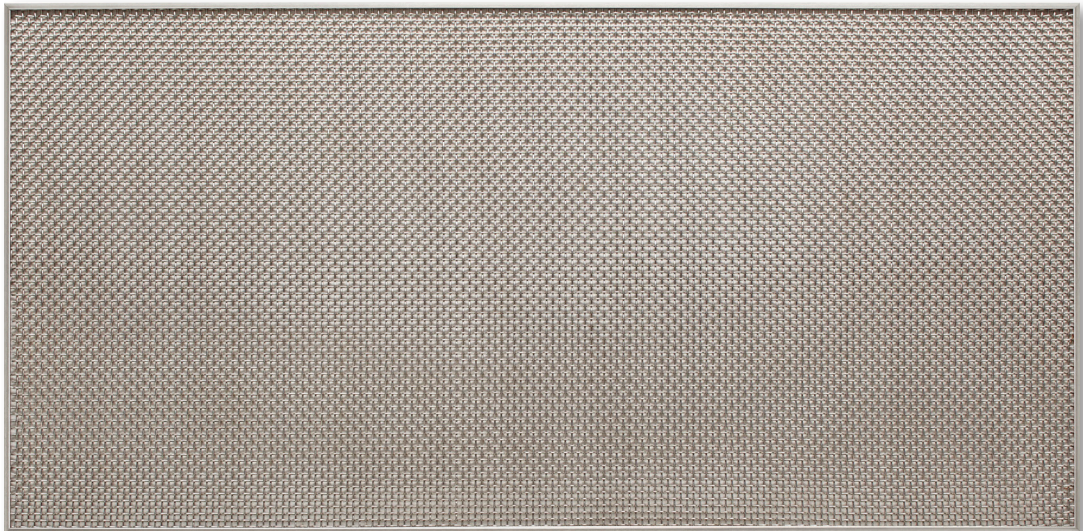

Stainless Steel Mesh #6, .047 Gauge, captured in an extruded MRBAS aluminum frame.
COM materials may also be applied; contact Customer Service.

Galleries for Desks & Credenzas
Stainless Steel Wire Mesh
Captured Frame

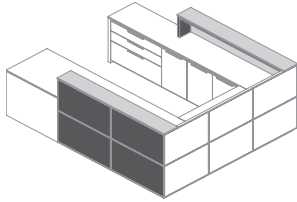

10.8d 43.8h	Prefix Code/Width Code:	Matrix Code:									
	PZG2WM...	...1x1	...1x2	...1x3	...2x1	...2x2	...2x3	...3x1	...3x2	...3x3	
Gallery/DeskCred WM 76w	...76...	15736	18096	20408	16589	18505	20171	17606	19776	22074	
Gallery/DeskCred WM 80w	...80...	16166	18558	20906	17026	18941	20688	17964	20133	22412	
Gallery/DeskCred WM 84w	...84...	16601	19033	21402	17459	19430	21164	18282	20450	22869	
Gallery/DeskCred WM 88w	...88...	17036	19536	21956	17938	19932	21678	18958	21204	23601	
Gallery/DeskCred WM 92w	...92...	17428	20013	22451	18376	20423	22195	19272	21597	23997	
Gallery/DeskCred WM 96w	...96...	17832	20495	22975	18803	20892	22717	19637	21922	24402	
Gallery/DeskCred WM 100w	...100...	18227	20892	23491	19229	21380	23232	20230	22597	25095	
Gallery/DeskCred WM 104w	...104...	18620	21276	23886	19728	21977	23947	20707	23153	25255	
Gallery/DeskCred WM 108w	...108...	19014	21672	24283	20164	22518	24419	21045	23549	25653	
Gallery/DeskCred WM 112w	...112...	19450	22107	24721	20640	22943	24980	21699	24303	26445	
Gallery/DeskCred WM 116w	...116...	19849	22510	25123	21084	23438	25499	22043	24627	26849	
Gallery/DeskCred WM 120w	...120...	20285	22949	25537	21560	23938	26055	22418	25025	27284	
Gallery/DeskCred WM 124w	...124...	20680	23345	25936	21984	24429	26571	23054	25697	27978	

! Notes:

Determine product number by merging Prefix, Width and Matrix Codes; reference the price. Ex: PZG2WM761X1= \$15736.
Order Gallery Top separately and tag to your selection here.

Designate placement of Gallery on Desk or Credenza as user's Left, Center or Right.

+ Options/Parametrics:

Width range: 60-124; specify as Width Code and use next larger standard size for pricing.

Galleries for Runoffs
Stainless Steel Wire Mesh
Captured Frame

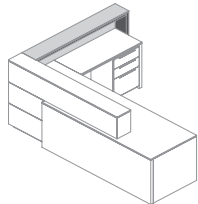

10.8d 43.8h	Prefix Code/Width Code:	Matrix Code:									
	PZG3WM...	...1x1	...1x2	...1x3	...2x1	...2x2	...2x3	...3x1	...3x2	...3x3	
Gallery/Runoff WM 40w LH	...40L...	10302	11718	13323	11174	12509	13638	12179	13820	15566	
Gallery/Runoff WM 40w RH	...40R...	10302	11718	13323	11174	12509	13638	12179	13820	15566	
Gallery/Runoff WM 48w LH	...48L...	11181	12677	14342	12039	13467	14677	12860	14499	16363	
Gallery/Runoff WM 48w RH	...48R...	11181	12677	14342	12039	13467	14677	12860	14499	16363	
Gallery/Runoff WM 56w LH	...56L...	12039	13611	15334	12897	14393	15708	13813	15569	17454	
Gallery/Runoff WM 56w RH	...56R...	12039	13611	15334	12897	14393	15708	13813	15569	17454	
Gallery/Runoff WM 64w LH	...64L...	12914	14547	16372	13780	15352	16707	14810	16609	18611	
Gallery/Runoff WM 64w RH	...64R...	12914	14547	16372	13780	15352	16707	14810	16609	18611	
Gallery/Runoff WM 72w LH	...72L...	13820	15538	17421	14677	16346	17778	15504	17403	19447	
Gallery/Runoff WM 72w RH	...72R...	13820	15538	17421	14677	16346	17778	15504	17403	19447	
Gallery/Runoff WM 80w LH	...80L...	14677	16478	18432	15538	17242	18810	16478	18432	20535	
Gallery/Runoff WM 80w RH	...80R...	14677	16478	18432	15538	17242	18810	16478	18432	20535	
Gallery/Runoff WM 88w LH	...88L...	15478	17410	19468	16416	18200	19769	17435	19468	21693	
Gallery/Runoff WM 88w RH	...88R...	15478	17410	19468	16416	18200	19769	17435	19468	21693	
Gallery/Runoff WM 96w LH	...96L...	16262	18359	20462	17276	19154	20801	18107	20183	22483	
Gallery/Runoff WM 96w RH	...96R...	16262	18359	20462	17276	19154	20801	18107	20183	22483	

! Notes:

Determine product number by merging Prefix, Width and Matrix Codes; reference the price. Ex: PZG3WM40L1X1= \$10302.

Order Gallery Top separately and tag to your selection here.

+ Options/Parametrics:

Width range: 32-96; specify as Width Code and use next larger standard size for pricing.

Galleries for Bridges
Stainless Steel Wire Mesh
Captured Frame

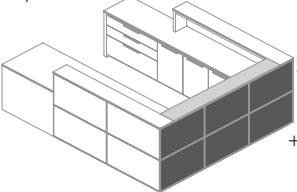

10.8d 43.8h	Prefix Code/Width Code:	Matrix Code:									
	PZG4WM...	...1x1	...1x2	...1x3	...2x1	...2x2	...2x3	...3x1	...3x2	...3x3	
Gallery/Bridge WM 96w (40)	...96...	-	-	-	15749	17415	18882	16582	18447	20567	
Gallery/Bridge WM 104w (48)	...104...	-	-	-	18638	20780	22503	19516	21813	23733	

! Notes:

Determine product number by merging Prefix, Width and Matrix Codes; reference the price. Ex: PZG2WM962X1= \$15749.
Order Gallery Top separately and tag to your selection here.

+ Options/Parametrics:

Width range: 92-104; specify as Width Code and use next larger standard size for pricing; bridge top must be 56-in less.

Gallery Surround Panels
Gilded Cork
Captured Frame with Glass

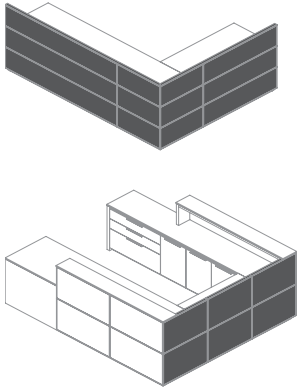

2d 43.8h	Prefix Code/Width Code:		Matrix Code:		
	PZG1GC...1x1	...1x2	...1x3
Gallery/Surround GC 21w	...21...		5002	6437	7131
Gallery/Surround GC 24w	...24...		5328	6779	7505
Gallery/Surround GC 28w	...28...		5670	7164	7924
Gallery/Surround GC 32w	...32...		5987	7514	8307
Gallery/Surround GC 36w	...36...		6313	7886	8716
Gallery/Surround GC 40w	...40...		-	8201	9079
Gallery/Surround GC 44w	...44...		-	8544	9444
Gallery/Surround GC 48w	...48...		-	8877	9828
Gallery/Surround GC 52w	...52...		-	9206	10192
Gallery/Surround GC 56w	...56...		-	9637	10651
Gallery/Surround GC 60w	...60...		-	10004	11064
Gallery/Surround GC 64w	...64...		-	10341	11448
Gallery/Surround GC 68w	...68...		-	10707	11828
Gallery/Surround GC 72w	...72...		-	11064	12241
Gallery/Surround GC 76w	...76...		-	11428	12656
Gallery/Surround GC 80w	...80...		-	11772	13014
Gallery/Surround GC 84w	...84...		-	12136	13417
Gallery/Surround GC 88w	...88...		-	12470	13820
Gallery/Surround GC 92w	...92...		-	12834	14182
Gallery/Surround GC 96w	...96...		-	13200	14588
Gallery/Surround GC 100w	...100...		-	-	14990

! Notes:
 Determine product number by merging Prefix, Width and Matrix Codes; reference the price. Ex: PZG1GC211X1= \$5002.
 + Options/Parametrics:
 Width range: 8-100; specify as Width Code and use next larger standard size for pricing.

Captured frames
have a 0.19-in lip.



Innovations® Gilded Cork GCO-104 Cool Silver, captured with glass in an extruded MRBAS aluminum frame. Additional colors available; see [vendor's online site](#). COM materials may also be applied; contact Customer Service.

Galleries for Desks & Credenzas
Gilded Cork
Captured Frame with Glass

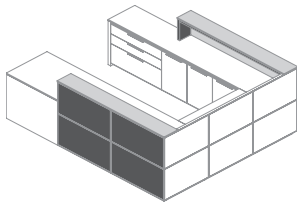

		Prefix Code/Width Code:		Matrix Code:								
10.8d	43.8h	PZG2GC...	...1x1	...1x2	...1x3	...2x1	...2x2	...2x3	...3x1	...3x2	...3x3	
Gallery/DeskCred GC 76w	...76...	...	-	15120	17476	13628	15542	17237	14587	16720	19041	
Gallery/DeskCred GC 80w	...80...	...	-	15465	17832	13944	15850	17595	14845	16996	19319	
Gallery/DeskCred GC 84w	...84...	...	-	15820	18227	14247	16207	17951	15083	17237	19655	
Gallery/DeskCred GC 88w	...88...	...	-	16191	18666	14606	16601	18387	15560	17791	20210	
Gallery/DeskCred GC 92w	...92...	...	-	16550	19023	14913	16960	18782	15796	18069	20549	
Gallery/DeskCred GC 96w	...96...	...	-	16899	19423	15233	17297	19186	16059	18353	20833	
Gallery/DeskCred GC 100w	...100...	...	-	19821	15526	17654	19584	16457	18831	21347		
Gallery/DeskCred GC 104w	...104...	...	-	15908	18118	20178	16855	19305	21447			
Gallery/DeskCred GC 108w	...108...	...	-	16226	18554	20535	17091	19584	21785			
Gallery/DeskCred GC 112w	...112...	...	-	16567	18870	20932	17568	20136	22340			
Gallery/DeskCred GC 116w	...116...	...	-	16893	19233	21337	17832	20385	22625			
Gallery/DeskCred GC 120w	...120...	...	-	17237	19628	21769	18089	20699	22999			
Gallery/DeskCred GC 124w	...124...	...	-	17540	19957	22169	18548	21214	23516			

! Notes:

Determine product number by merging Prefix, Width and Matrix Codes; reference the price. Ex: PZG2GC761X2= \$15120.
Order Gallery Top separately and tag to your selection here.
Designate placement of Gallery on Desk or Credenza as user's Left, Center or Right.

+ Options/Parametrics:

Width range: 60-124; specify as Width Code and use next larger standard size for pricing.

Galleries for Runoffs
Gilded Cork
Captured Frame with Glass

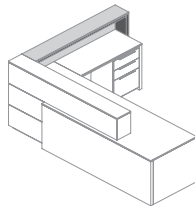

		Prefix Code/Width Code:		Matrix Code:								
10.8d	43.8h	PZG3GC...	...1x1	...1x2	...1x3	...2x1	...2x2	...2x3	...3x1	...3x2	...3x3	
Gallery/Runoff GC 40w LH	...40L...	...	-	10169	11795	9621	10978	12113	10579	12196	13960	
Gallery/Runoff GC 40w RH	...40R...	...	-	10169	11795	9621	10978	12113	10579	12196	13960	
Gallery/Runoff GC 48w LH	...48L...	...	-	10878	12556	10250	11670	12914	11080	12713	14579	
Gallery/Runoff GC 48w RH	...48R...	...	-	10878	12556	10250	11670	12914	11080	12713	14579	
Gallery/Runoff GC 56w LH	...56L...	...	-	11565	13330	10873	12359	13668	11755	13507	15431	
Gallery/Runoff GC 56w RH	...56R...	...	-	11565	13330	10873	12359	13668	11755	13507	15431	
Gallery/Runoff GC 64w LH	...64L...	...	-	12261	14111	11498	13052	14426	12458	14271	16290	
Gallery/Runoff GC 64w RH	...64R...	...	-	12261	14111	11498	13052	14426	12458	14271	16290	
Gallery/Runoff GC 72w LH	...72L...	...	-	12998	14902	12161	13805	15261	12992	14862	16947	
Gallery/Runoff GC 72w RH	...72R...	...	-	12998	14902	12161	13805	15261	12992	14862	16947	
Gallery/Runoff GC 80w LH	...80L...	...	-	13688	15674	12768	14467	16014	13668	15616	17739	
Gallery/Runoff GC 80w RH	...80R...	...	-	13688	15674	12768	14467	16014	13668	15616	17739	
Gallery/Runoff GC 88w LH	...88L...	...	-	14382	16457	13396	15187	16773	14347	16377	18598	
Gallery/Runoff GC 88w RH	...88R...	...	-	14382	16457	13396	15187	16773	14347	16377	18598	
Gallery/Runoff GC 96w LH	...96L...	...	-	15096	17211	14018	15875	17568	14845	16931	19212	
Gallery/Runoff GC 96w RH	...96R...	...	-	15096	17211	14018	15875	17568	14845	16931	19212	

! Notes:

Determine product number by merging Prefix, Width and Matrix Codes; reference the price. Ex: PZG3GC40L1X2= \$10169.

Order Gallery Top separately and tag to your selection here.

+ Options/Parametrics:

Width range: 32-96; specify as Width Code and use next larger standard size for pricing.

Galleries for Bridges
Gilded Cork
Captured Frame with Glass

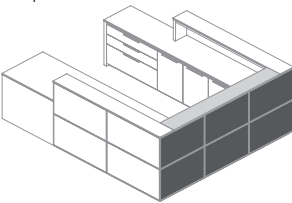

		Prefix Code/Width Code:		Matrix Code:								
10.8d	43.8h	PZG4GC...	...1x1	...1x2	...1x3	...2x1	...2x2	...2x3	...3x1	...3x2	...3x3	
Gallery/Bridge GC 96w (40)	...96...	...	-	13291	14996	12802	14454	15948	13629	15512	17595	
Gallery/Bridge GC 104w (48)	...104...	...	-	15012	17132	18916	15875	18162	20166			

! Notes:

Determine product number by merging Prefix, Width and Matrix Codes; reference the price. Ex: PZG4GC961X2= \$13291.
Order Gallery Top separately and tag to your selection here.

+ Options/Parametrics:

Width range: 92-104; specify as Width Code and use next larger standard size for pricing; bridge top must be 56-in less.

