

UNIVERS

TABLE PROGRAM

Planning Guide



TUOHY

Contents

Statement of Line	3
How to Specify	4
01. Recommended Seating Capacity	5
Round	6
Square	6
Rectangle	6
Video	7
Track	7
Boat	8
Ellipse	8
02. Edge Details	9
Edge Availability	10
Wood	11
Metal: Bevel	12
Metal: Square	13
Self: Bevel	14
Self: Cantilever	15
Self: Square	16
03. Edge & Top Finish Details	17
Top Surface Material & Finish Options	18
Finish Options	19
04. Base Details	21
Base Options	22
Base Finishes	23
Base Availability & Height	24
Round Kneespace	25
Square Kneespace	27
Rectangular Kneespace	29
Video Kneespace	47
Track Kneespace	64
Boat Kneespace	83
Ellipse Kneespace	103
05. Power Options	123
Base Styles	124
Power Routing Overview	134
Power Routing: In	135
Power Routing: Out	138

*Tip: Click on page numbers
to navigate this document*



Statement of Line

Table Shape Options

Multiple sizes available, ranging from 30" round or square to 240" W x 60" D. Special sizes available.



Round



Square



Rectangle



Video



Track



Boat



Ellipse

Edge Options

Solid Wood



Metal - Bevel



Metal - Square



Self - Bevel



Self - Cantilever



Self - Square



Base Options



Coda-Vee

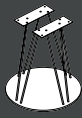

Coda-Wire



Coda-X



Cylinder



Plinth



Ryvit



Spyda-T



Spyda-X



Spyda-Y



Uffizi-Loop

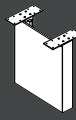

Zi-A

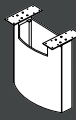

Zi-D

Power Options

Surface Power Units



Power-Comm Troughs (Single)

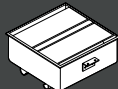

Power-Comm Troughs (Dual)



Power-Comm Recessed Consoles (GC & GCS)



Boho

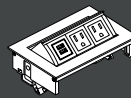

MhoB

Perimeter Power & Data Units

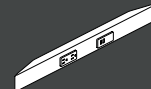

Power-Data Aprons



Garcia 2-Trac

How to Specify

The Univers Conference line is an extensive system for pairing top shapes, materials and edges with an array of styled bases and power options. This planning guide will guide you through determining the specifications for the table your client needs.

1. Select the Top Shape and Size.

To begin, determine the number of seats needed at the table to identify the table top size and shape.

Univers Conference tables are available in seven top shapes and numerous sizes.

2. Select the Top/Edge Surface combination for your table

- a. Choose the surface option for the top
- b. Choose from a Wood, Metal or Self Edge edge detail.

Univers has five edge details and nine surface material options. These can be configured in numerous ways.

Note: Curved Top shapes (circle, track, ellipse) do not allow for certain edge details.

3. Select the Finish Options for the Top and Edge details

4. Select the Base style and Base Finish option that support your Top shape and Edge detail

- a. Consider knee space dimensions (pages 25-103)

5. Select the Power Unit.

- a. Consider power unit placement (pages 125-138)



Recommended Seating Capacity



Recommended Seating Capacity

Seating capacity is based on 27" per person.

Round

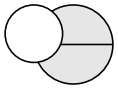

Diameter	Seats	Pieces
30"	2-3	1
36"	3-4	1
42"	3-5	1
48"	4-5	1
54"	4-7	2
60"	5-7	2
66"	6-8	2
72"	6-9	2

Square



Diameter	Seats	Pieces
30"	2-3	1
36"	3-4	1
42"	3-5	1
48"	4-5	1
54"	4-7	2
60"	5-7	2

Rectangle

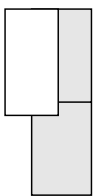

Width	Depth						Pieces
	30"	36"	39"	42"	48"	52"	
42"	4	-	-	-	-	-	1
60"	4-6	-	-	-	-	-	1
72"	-	4-6	-	-	-	-	1
78"	-	-	6-8	-	-	-	1
84"	-	-	-	6-8	-	-	1
90"	-	-	-	-	6-8	-	1
96"	-	-	-	-	6-12	-	1
108"	-	-	-	-	8-12	-	1
120"	-	-	-	-	-	8-14	1
132"	-	-	-	-	-	8-14	2
144"	-	-	-	-	-	10-16	2

Note:

- › Seating allowance per table is dependent on the chair selected for use with the Univers Table.
- › All sizes are given in nominal dimensions.
- › Available shapes are dependent on desired edge style.

Seating capacity is based on 27" per person.

Video

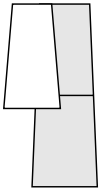

2nd Listed Depth



1st Listed Depth

Width	Depth						Pieces
	39/26"	42/28"	48/36"	52/40"	56/44"	60/44"	
78"	5-7	-	-	-	-	-	1
84"	-	5-7	-	-	-	-	1
90"	-	-	5-7	-	-	-	1
96"	-	-	5-9	-	-	-	1
108"	-	-	7-9	7-11	-	-	1
120"	-	-	-	7-11	-	-	1
132"	-	-	-	9-13	-	-	2
144"	-	-	-	-	9-15	-	2
156"	-	-	-	-	9-15	-	2
168"	-	-	-	-	9-15	-	2
180"	-	-	-	-	9-15	-	2
192"	-	-	-	-	-	11-18	2
204"	-	-	-	-	-	11-18	2
216"	-	-	-	-	-	13-20	2
240"	-	-	-	-	-	13-22	2

Track

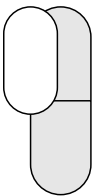

Width	Depth								Pieces
	30"	36"	39"	42"	48"	52"	54"	60"	
42"	2-4	-	-	-	-	-	-	-	1
60"	4-6	-	-	-	-	-	-	-	1
72"	-	6-8	-	-	-	-	-	-	1
78"	-	-	6-8	-	-	-	-	-	1
84"	-	-	-	6-8	-	-	-	-	1
90"	-	-	-	6-8	-	-	-	-	1
96"	-	-	-	-	6-12	-	-	-	1
108"	-	-	-	-	-	8-12	-	-	1
120"	-	-	-	-	-	-	8-14	-	2
132"	-	-	-	-	-	-	8-14	-	2
144"	-	-	-	-	-	-	10-16	-	2
156"	-	-	-	-	-	-	-	10-18	2
168"	-	-	-	-	-	-	-	10-18	2
180"	-	-	-	-	-	-	-	12-20	2
192"	-	-	-	-	-	-	-	12-20	2
204"	-	-	-	-	-	-	-	12-20	2
216"	-	-	-	-	-	-	-	14-22	2
240"	-	-	-	-	-	-	-	16-26	4

Note:

- › Seating allowance per table is dependent on the chair selected for use with the Univers Table.
- › All sizes are given in nominal dimensions.
- › Available shapes are dependent on desired edge style.

Seating capacity is based on 27" per person.

Boat

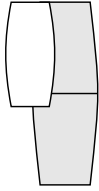

2nd Listed Depth

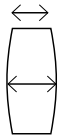

1st Listed Depth



Width	Depth								Pieces
	30/24"	36/28"	39/30"	42/30"	48/32"	52/34"	54/36"	60/40"	
42"	2-4	-	-	-	-	-	-	-	1
60"	4-6	-	-	-	-	-	-	-	1
72"	-	6	-	-	-	-	-	-	1
78"	-	-	6-8	-	-	-	-	-	1
84"	-	-	-	6-8	-	-	-	-	1
90"	-	-	-	6-8	-	-	-	-	1
96"	-	-	-	-	6-10	-	-	-	1
108"	-	-	-	-	-	8-10	-	-	1
120"	-	-	-	-	-	-	8-12	-	2
132"	-	-	-	-	-	-	8-12	-	2
144"	-	-	-	-	-	-	10-14	-	2
156"	-	-	-	-	-	-	-	10-16	2
168"	-	-	-	-	-	-	-	10-16	2
180"	-	-	-	-	-	-	-	10-16	2
192"	-	-	-	-	-	-	-	10-16	2
204"	-	-	-	-	-	-	-	12-20	2
216"	-	-	-	-	-	-	-	14-22	2
240"	-	-	-	-	-	-	-	14-22	4

Ellipse

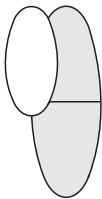

2nd Listed Depth

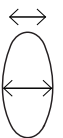

1st Listed Depth



Width	Depth								Pieces
	30/24"	36/24"	39/26"	42/28"	48/32"	52/34"	54/36"	60/40"	
42"	2-4	-	-	-	-	-	-	-	1
60"	4-6	-	-	-	-	-	-	-	1
72"	-	6	-	-	-	-	-	-	1
78"	-	-	6-8	-	-	-	-	-	1
84"	-	-	-	6-8	-	-	-	-	1
90"	-	-	-	-	6-8	-	-	-	1
96"	-	-	-	-	6-10	-	-	-	1
108"	-	-	-	-	-	8-10	-	-	1
120"	-	-	-	-	-	-	8-12	-	2
132"	-	-	-	-	-	-	8-12	-	2
144"	-	-	-	-	-	-	10-14	-	2
156"	-	-	-	-	-	-	-	10-16	2
168"	-	-	-	-	-	-	-	10-16	2
180"	-	-	-	-	-	-	-	10-16	2
192"	-	-	-	-	-	-	-	12-20	2
204"	-	-	-	-	-	-	-	12-20	2
216"	-	-	-	-	-	-	-	14-22	2
240"	-	-	-	-	-	-	-	14-24	4

Note:

- › Seating allowance per table is dependent on the chair selected for use with the Univers Table.
- › All sizes are given in nominal dimensions.
- › Available shapes are dependent on desired edge style.

Edge Details

The Univers conference table system offers over 70 table top material and edge details options.

Begin by choosing from Wood edge details, Metal edge with a bevel or square detail, or a Self Edges with a bevel, cantilever or square edge details.



Edge Availability

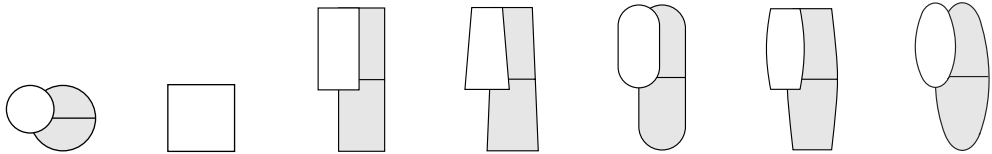

Edges	Round	Square	Rectangular	Video	Track	Boat	Ellipse
Bevel Metal 2th		•	•	•			
Bevel Self Wood 1.5th	•	•	•	•	•	•	•
Bevel Self 1.5th	•	•	•	•	•	•	•
Bevel PVC 1.5th	•	•	•	•	•	•	•
Bevel Self / Wood 1.5th	•	•	•	•	•	•	•
Bevel Self / Wood 2th	•	•	•	•	•	•	•
Bevel Self 2th	•	•	•	•	•	•	•
Bevel PVC 2.th	•	•	•	•	•	•	•
Cantilever Self 2th	•	•	•	•	•	•	•
Cantilever PVC 2th	•	•	•	•	•	•	•
Square Metal 1.5th		•	•	•			
Square Metal 2th		•	•	•			
Square Self 2th	•	•	•	•	•	•	•
Square Self 1.5th	•	•	•	•	•	•	•
Square PVC 1.5th	•	•	•	•	•	•	•
Solid Wood 1.5th	•	•	•	•	•	•	•
Solid Wood 2th	•	•	•	•	•	•	•

Note: See price list for specific size or edge offering, per material.

Wood

Choose your table top finish materials and edge materials.

Solid Edge 1.5" Thick

Wood 1



USW1W
Wood 1 veneer and solid edges



Acid-Etched Glass



USW1A / USW1L (Laminate Glass)
Wood 1 veneer and solid edges



Back-Painted Glass

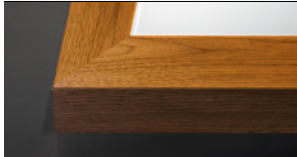

USW1B
S.BLK Black, S.BWT White Wood 1 solid edges



Acrylic Solid Surface

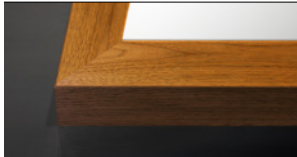

USW1C
Avonite® Polaris Wood 1 solid edges

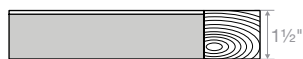

HPL

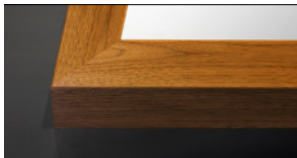

USW1H
Formica® 949 White Wood 1 solid edges



Faux Leather

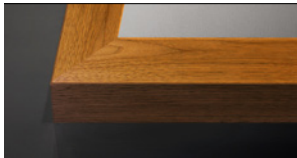

USW1F
Silex – all colors Wood 1 solid edges



Marble

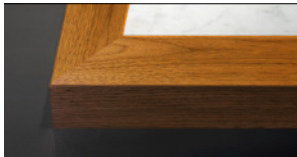

USW1M
Carrara Marble Wood 1 solid edges



Quartz



USW1Q
Cambria® – all standard colors* Wood 1 solid edges



Solid Edge 2" Thick

Wood 1

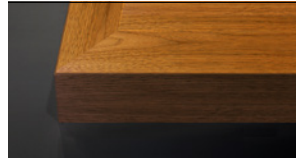

USW2W
Wood 1 veneer and solid edges



Acid-Etched Glass



USW2A / USW2L (Laminate Glass)
GAB Black, GAW White Wood 1 solid edges



Back-Painted Glass

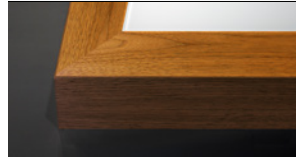

USW2B
S.BLK Black, S.BWT White Wood 1 solid edges

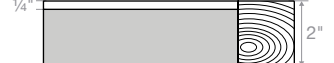

Acrylic Solid Surface

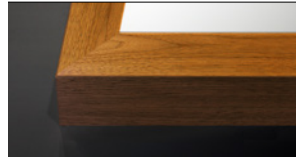

USW2C
Avonite® Polaris Wood 1 solid edges



HPL

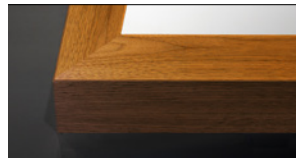

USW2H
Formica® 949 White Wood 1 solid edges



Faux Leather

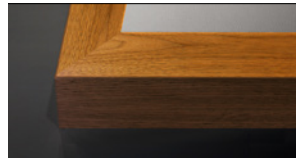

USW1F
Silex – all colors Wood 1 solid edges



Marble

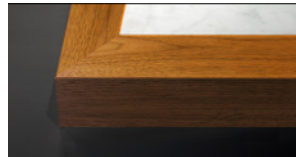

USW2M
Carrara Marble Wood 1 solid edges

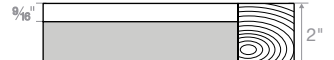

Quartz

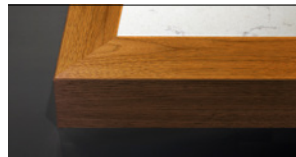

USW2Q
Cambria® – all standard colors* Wood 1 solid edges

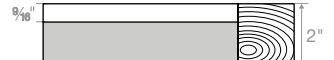

Metal: Bevel

2" Thick

Wood 1

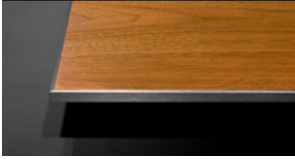

UBM2W
All colors

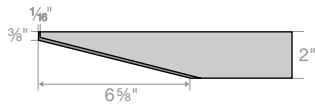

Acid-Etched Glass



UBM2A / UBM2L (Laminate Glass) GAB Black,
GAW White

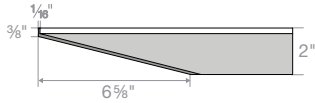

Back-Painted Glass



UBM2B
S.BLK Black, S.BWT White

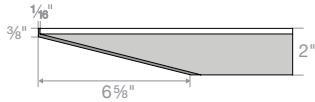

Acrylic Solid Surface



UBM2C
Avonite® Polaris

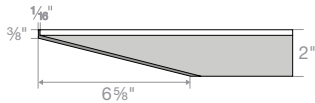

HPL



UBM2H
Formica® 949 White

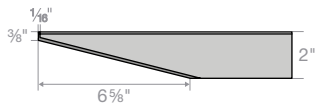

Faux Leather



UBM2F
Silex – all colors

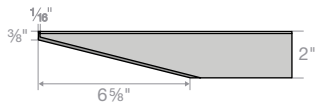

Marble

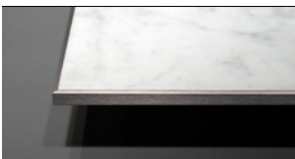

UBM2M
Carrara Marble

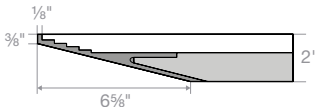

Quartz



UBM2Q
Cambria®-all standard colors*

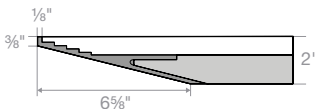

Note: Bevel metal edge not available on round, track, boat or ellipse

Metal: Square

1.5" Thick

Wood 1



USM1W
All colors

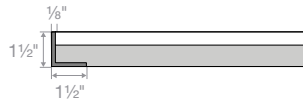

Acid-Etched Glass



USM1A / USM1L (Laminated Glass)
GAB Black, GAW White

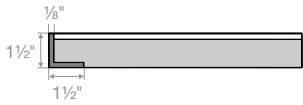

Back-Painted Glass



USM1B
S.BLK Black, S.BWT White

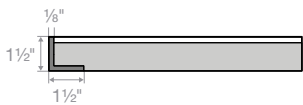

Acrylic Solid Surface



USM1C
Avonite® Polaris

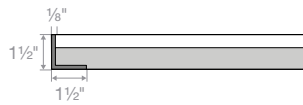

HPL



USM1H
Formica® 949 White



Faux Leather



USM1F
Silex - all colors

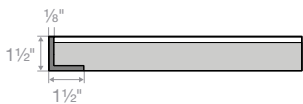

Marble



USM1M
Carrara Marble

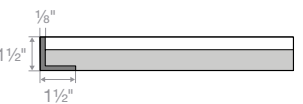

Quartz



USM1Q
Cambria®-all standard colors*



2" Thick

Wood 1



USM2W
All colors

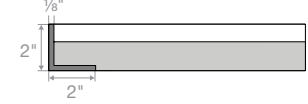

Acid-Etched Glass

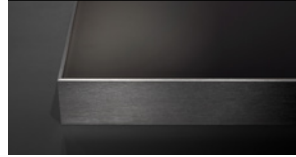

USM2A / USM2L (Laminated Glass)
GAB Black, GAW White

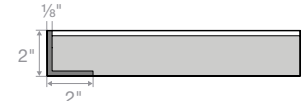

Back-Painted Glass



USM2B
S.BLK Black, S.BWT White

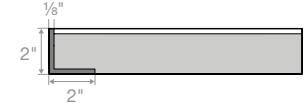

Acrylic Solid Surface



USM2C
Avonite® Polaris

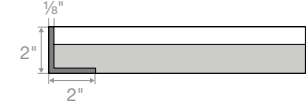

HPL



USM2H
Formica® 949 White

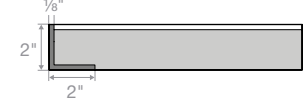

Faux Leather

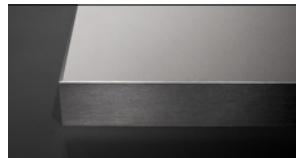

USM2F
Silex -all colors

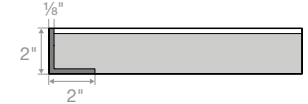

Marble

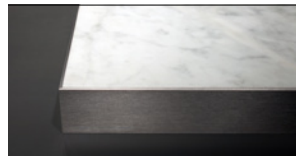

USM2M
Carrara Marble

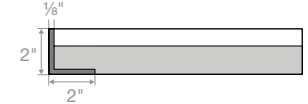

Quartz



USM2Q
Cambria®-all standard colors*

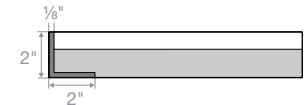

Note: Square Metal Edge Not available on Round, Track, Boat or Ellipse.

Self: Bevel

1.5" Thick

Wood 1

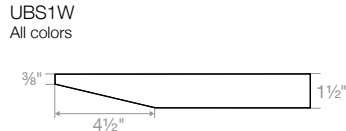

Acid-Etched Glass

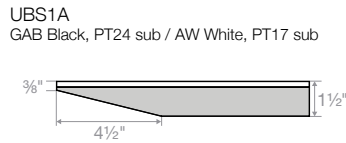

Back-Painted Glass

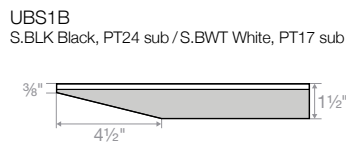

Acrylic Solid Surface

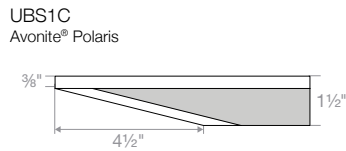

HPL

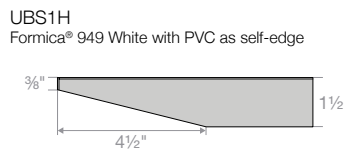
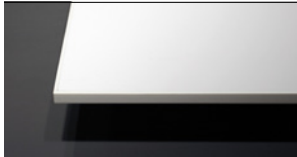

Marble

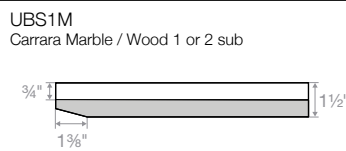
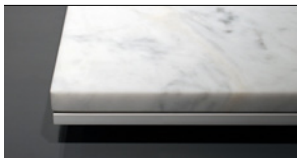

Quartz

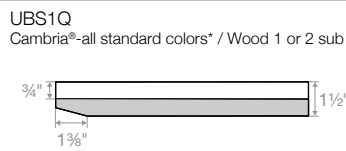

2" Thick

Wood 1

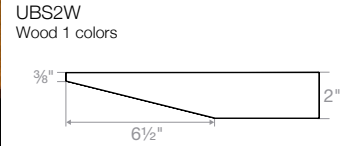

Acid-Etched Glass

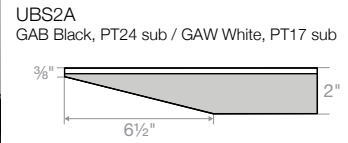

Back-Painted Glass

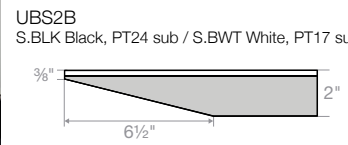

Acrylic Solid Surface

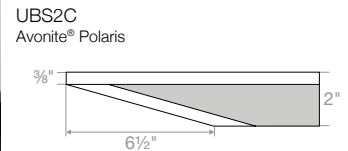

HPL

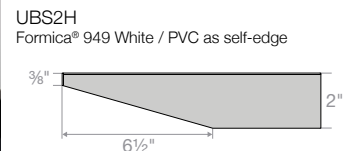

Marble

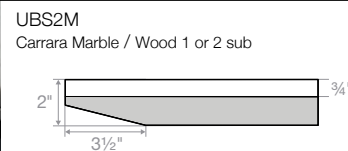

Quartz

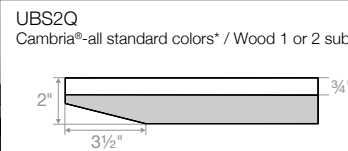

Self: Cantilever

2" Thick

Wood 1



UCS2W
Wood 1 colors

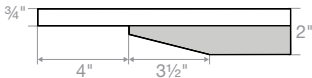

Acrylic Solid Surface



UCS2C...
Avonite® Polaris

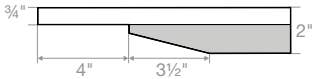

HPL



UCS2H...
Formica® 949 White / PVC as self-edge

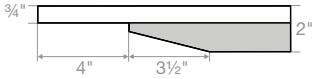

Marble



UCS2M
Carrara Marble

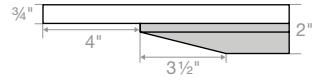

Quartz



UCS2Q
Cambria®-all standard colors*

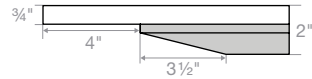

Self: Square

1.5" Thick

Wood 1

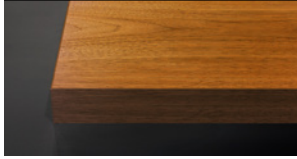

USS1W
All colors

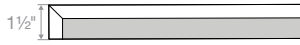

Acid-Etched Glass

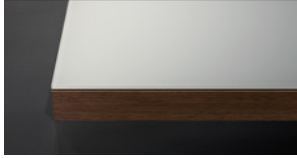

USS1A
GAB Black, GAW White / Wood 1 or 2 sub

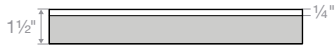

Back-Painted Glass



USS1B
S.BLK Black, S.BWT White / Wood 1 or 2 sub



Acrylic Solid Surface

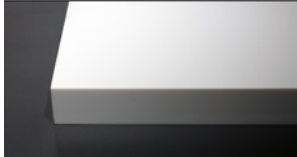

USS1C
Avonite® Polaris

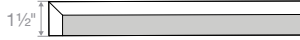

HPL

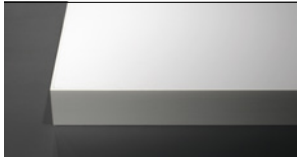

USS1H
Formica® 949 White



Marble

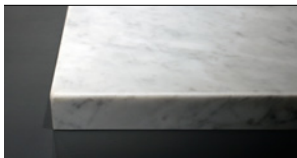

USS1M
Carrara Marble

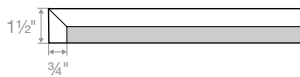

Quartz



USS1Q
Cambria®-all standard colors*

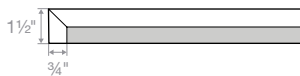

2" Thick

Wood 1

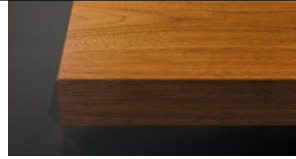

USS2W
All colors



Acid-Etched Glass

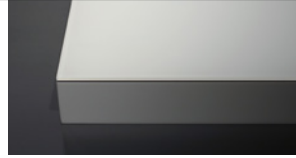

USS2A
GAB Black, GAW White / Wood 1 or 2 sub



Back-Painted Glass



USS2B
S.BLK Black, S.BWT White / Wood 1 or 2 sub



Acrylic Solid Surface



USS2C
Avonite® Polaris

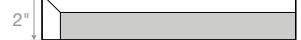

HPL



USS2H
Formica® 949 White, PVC as self edge



Marble

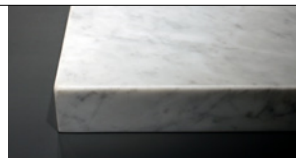

USS2M
Carrara Marble

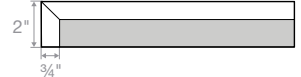

Quartz



USS2Q
Cambria®-all standard colors*

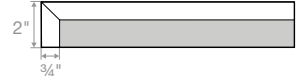

Edge & Top Finish Details

This program of materials paired with edge shapes and details demonstrates the considerable latitude in design solutions available to you through TUOHY's table programs.



Top Surface Material & Finish Options

Wood 1

Veneers & Solid Color

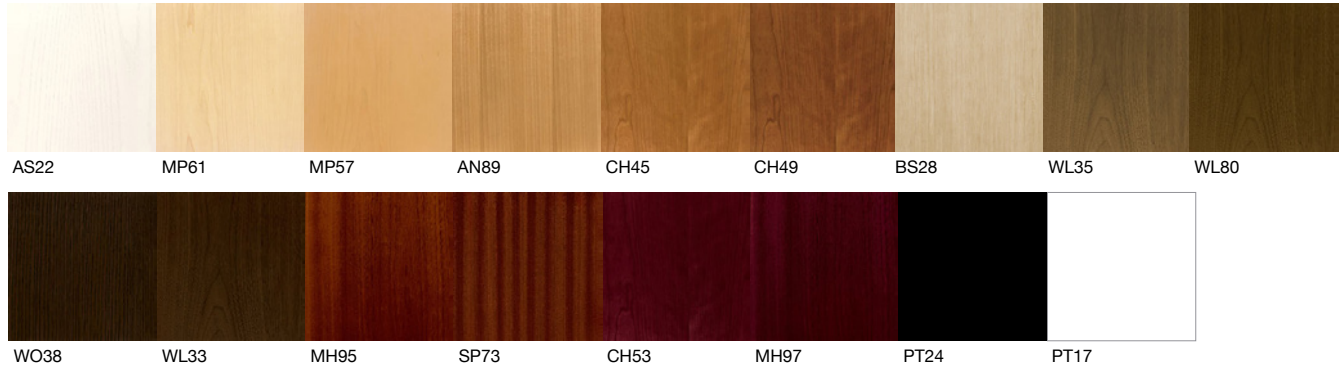

Wood 2

Veneer

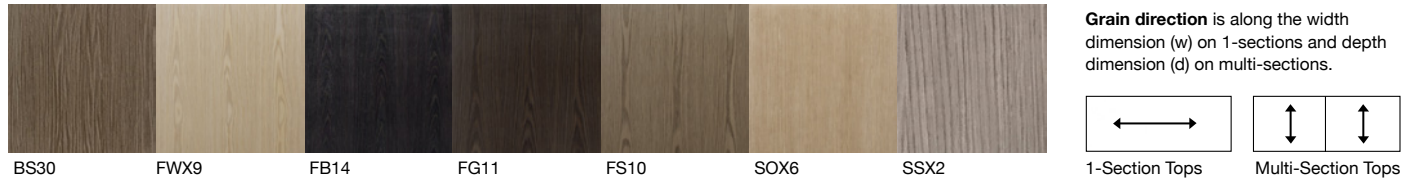

AE Glass

Acid-Etched



AL Glass

A-Etch / Laminated

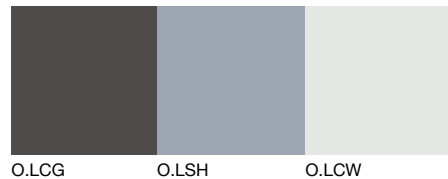

BP Glass

Back-Painted

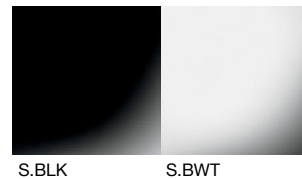

Acrylic

Solid Surface



HPL

White (PVC edge)

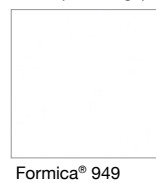

Faux Leather

Silex

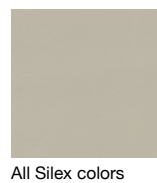

Marble

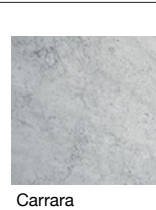

Quartz

Cambria®

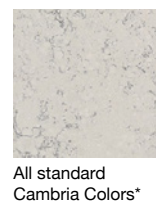

Metal

Edges Only

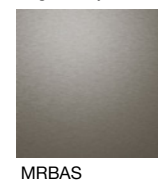

Solid Color finishes have MDF cores and are suitable for all surfaces except table tops and work surfaces. High Gloss Solid Color finishes have a smooth but non-polished, high luster presentation.

* quote required for Cambria Matte™ & Luxury Design Series

Finish Options

Wood Solid Colors

Wood 1

Satin White	PT17
Satin Ebony	PT24
High Gloss White	PTG1
High Gloss Ebony	PTG2

Solid Color finishes have MDF cores and are suitable for all surfaces except tables and work surfaces. High Gloss Solid Color finishes have a smooth but non-polished, high luster presentation.

Wood Species

Wood 1	Satin Open (Std)	Species	Cut	Solid Edge Availability
Light Anigre	AN89	Anigre	Quartered-plain	Yes
Blanco Ash	AS22	Ash	Plain-sliced	Yes
Whitened Oak	BS28	Oak	Reconstituted	Yes
Light Cherry	CH45	Cherry	Plain-sliced	Yes
Medium Cherry	CH49	Cherry	Plain-sliced	Yes
Dark Cherry	CH53	Cherry	Plain-sliced	Yes
Medium Mahogany	MH95	Mahogany	Plain-sliced	Yes
Dark Mahogany	MH97	Mahogany	Plain-sliced	Yes
Light Maple	MP61	Maple	Plain-sliced	Yes
White Maple	MP57	Maple	Plain-sliced	Yes
Medium Sapele	SP73	Sapele	Ribbon	Yes
Catalan Walnut	WL33	Walnut	Plain-sliced	Yes
Scandia Walnut	WL35	Walnut	Plain-sliced	Yes
Mezzo Walnut	WL80	Walnut	Plain-sliced	Yes
Tangiers Oak	WO38	White Oak	Rift	Yes

Wood 2	Satin Open +5%	Species	Cut	Solid Edge Availability
Mateo Gray	BS30	Oak	Reconstituted	No
Flamed Black	FB14	Oak	Reconstituted	No
Flamed Gray	FG11	Oak	Reconstituted	No
Flamed Sand	FS10	Oak	Reconstituted	No
Flamed White	FWX9	Oak	Reconstituted	No
Sand Oak	SOX6	Oak	Reconstituted	No
Striped Sand	SSX2	Oak	Reconstituted	No

Metals, Glass, Stone & HPL

The materials and finishes shown below are standard selections from TUOHY. Please inquire about the use of customer's own materials not shown here.

Metal

Brushed Nickel	MBN
Brushed Stainless Steel	MBSS
Polished Aluminum	MPA
Polished Chrome	MPC
Resin Black	MRB
Resin Black Matte	MRBM
Resin Brushed Aluminum	MRBA
Resin Brushed Aluminum with Steel Tint	MRBAS
Resin Brushed Steel	MRBS
Resin Metal Bronze	MRBZ
Resin Satin Aluminum	MRSA
Resin Thunder Gray	MRTG
Resin White	MRW

Glass

Low Iron Glass (non-tinted)	Low Iron
Low Iron Glass, Back-Painted Black 0.25th	S.BLK
Low Iron Glass, Back-Painted White 0.25th	S.BWT
Low Iron Glass, Acid-Etched BP-Black 0.25th	GAB
Low Iron Glass, Acid-Etched BP-White 0.25th	GAW
Ocuwrite White 0.25th	O.BWT
Ocuwrite Castlegate Gray (Laminated) 0.25th	O.LGC
Ocuwrite Cool White (Laminated) 0.25th	O.LCW
Ocuwrite Stone Harbor (Laminated) 0.25th	O.LSH

Acrylic Solid Surface

Avonite® 8256 Polaris, Matte	Matte White
Avonite® 8256 Polaris, Polished	Polished White

Quartz

Cambria®	All std colors; excl. Matte™ & Luxury Design Series
----------	---

Natural Stone

Carrara Marble	Carrara
----------------	---------

HP Laminate

Formica® 949 White	949 White
--------------------	-----------

Base Details

The versatility of the Univers offering is in part because of the base options. With multiple materials and shapes, the configuration options are endless. There are 12 bases and numerous finish options.



Base Options

Base Styles Codes & Symbols:

MPA	Polished Aluminum
MPC	Polished Chrome
MRBAS	Resin Brushed Aluminum, Steel Tint
MRBS	Resin Brushed Steel
Resin (SC)	All Resin Solid Color Finishes
W1	Wood 1 Colors
Ø	Power-Data Pathway

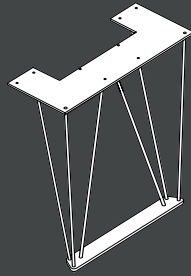

Coda-Vee
Resin (SC)

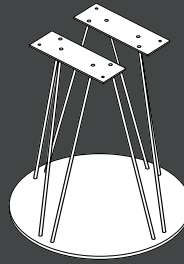

Coda-Wire
Resin (SC)



Coda-X
MRBAS

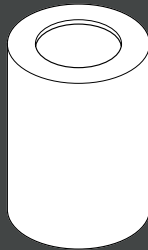

Cylinder
Wood 1 Ø

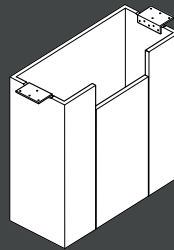

Plinth
Wood 1 Ø

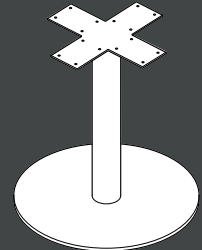

Ryvit
MRBS

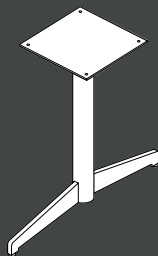

Spyda-T
MRBS

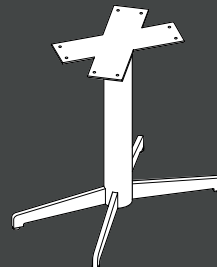

Spyda-X
MRBS

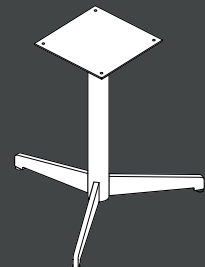

Spyda-Y
MRBS

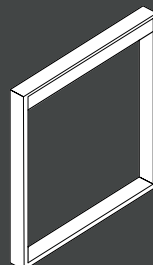

Uffizi-Loop
MRBAS

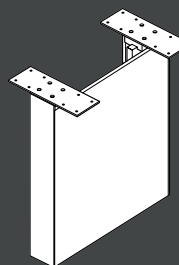

Zi-A
Wood 1 + MRBAS (trim) Ø

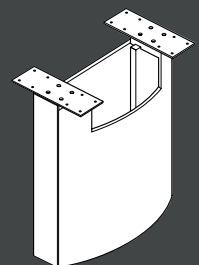

Zi-D
Wood 1 + MRBAS (trim) Ø

Base Finishes

**Metal Base
Finish Options**

Brushed Nickel	MBN
Brushed Stainless Steel	MBSS
Polished Aluminum	MPA
Polished Chrome	MPC
Resin Black	MRB
Resin Black Matte	MRBM
Resin Brushed Aluminum	MRBA
Resin Brushed Aluminum with Steel Tint	MRBAS
Resin Brushed Steel	MRBS
Resin Satin Aluminum	MRSA
Resin Thunder Gray	MRTG
Resin White	MRW

**Wood Base
Finish Options**

Wood 1	Satin Open (Std)
Satin White	PT17
Satin Ebony	PT24
High Gloss White	PTG1
High Gloss Ebony	PTG2

Base Availability & Height

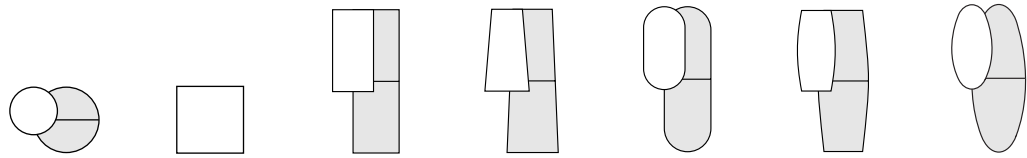

Bases	Round	Square	Rectangular	Video	Track	Boat	Ellipse
Coda-Vee			•	•	•	•	•
Coda-Wire	•	•	•	•	•	•	•
Coda-X			•	•	•	•	•
Cylinder			•	•	•	•	•
Plinth	•	•	•	•	•	•	•
Ryvit	•	•	•	•	•	•	•
Spyda-T			•	•	•	•	•
Spyda-X	•	•	•	•	•	•	•
Spyda-Y			•	•	•	•	•
Uffizi-Loop	•	•	•	•	•	•	•
Zi-A			•	•	•	•	•
Zi-D			•	•	•	•	•

Note: See price list for specific size or edge offering, per material.

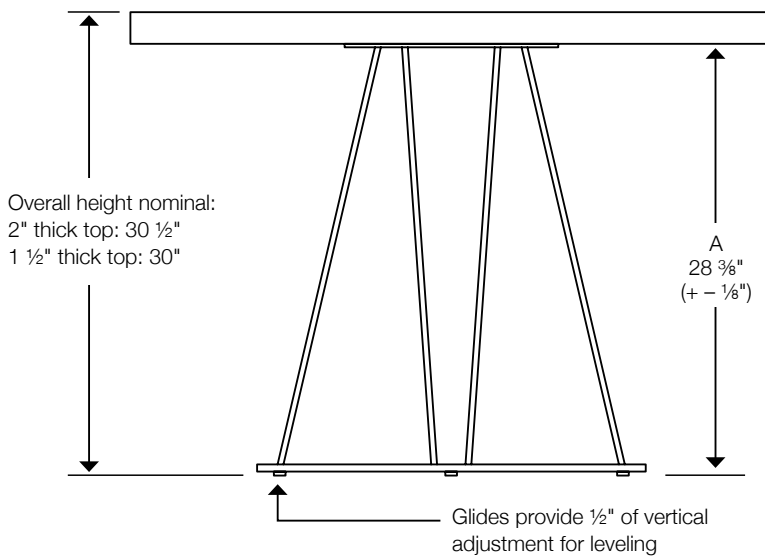

Note: 28-3/8" is the clearance under all tables (+/- 1/8") except tables with Uffizi-loop bases. Uffizi-loop bases offer 27-1/2" (+/- 1/8") clearance.

Round Kneespace

Based on the Shape and Edge Detail chosen, the following pages highlight the kneespace of each viable to Base configuration.

Coda-Wire Base

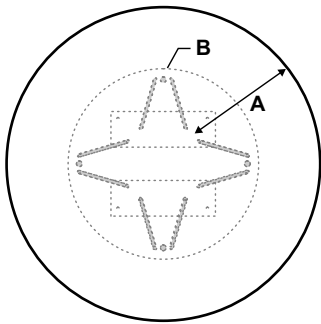

Top	A	B
42"	9 1/2"	25 1/2"
48"	12 1/2"	25 1/2"
54"	15 1/2"	25 1/2"
60"	18 1/2"	25 1/2"

Cylinder Base

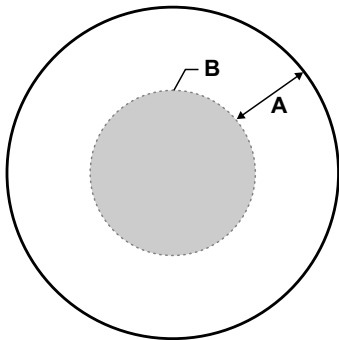

Top	A	B
36"	9"	18"
42"	12"	18"
48"	14"	20"
54"	15"	24"
60"	15"	30"
66"	18"	30"
72"	18"	36"

Ryvit Base

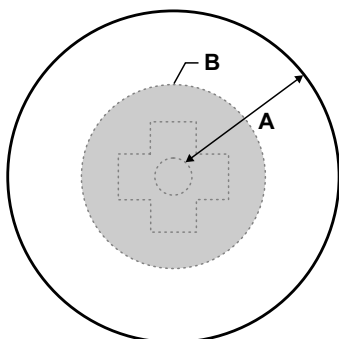

Top	A	B
30"	13"	20"
36"	16"	20"
42"	42"	26"
48"	22"	26"
54"	25"	30"
60"	28"	30"

Spyda-X Base

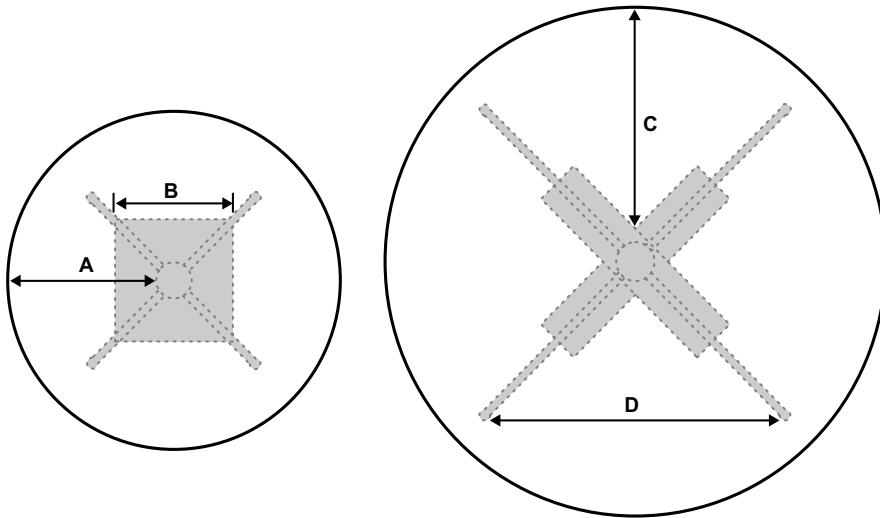

Top	A	B	C	D
30"	13 1/2"	13"	-	-
36"	16 1/2"	13"	-	-
42"	19 1/2"	13"	-	-
48"	22 1/2"	13"	-	-
54"	-	-	25"	32 1/2"
60"	-	-	28"	32 1/2"

Uffizi-Loop Base

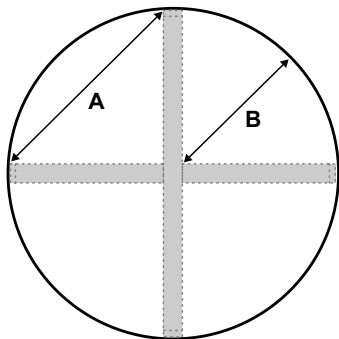

Top	A	B
42"	27 1/2"	19"
48"	32"	22"
54"	32"	25"
60"	32"	28"

Square Kneespace

Based on the Shape and Edge Detail chosen, the following pages highlight the kneespace of each viable to Base configuration.

Coda-Wire Base

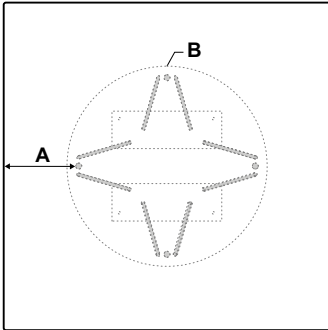

Top	A	B
42"	9 1/2"	25 1/2"
48"	12 1/2"	25 1/2"
54"	15 1/2"	25 1/2"

Plinth Base

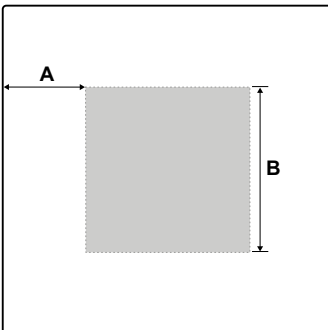

Top	A	B
36"	9"	18"
42"	12"	18"
48"	14"	20"
54"	17"	20"
60"	18"	24"

Ryvit Base

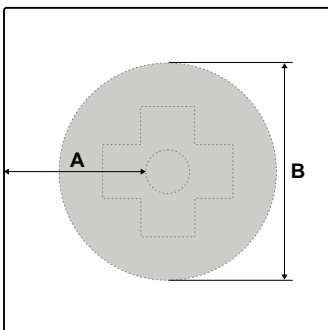

Top	A	B
30"	13"	20"
36"	16"	20"
42"	19"	26"
48"	22"	26"
54"	25"	30"
60"	28"	30"

Spyda-X Base

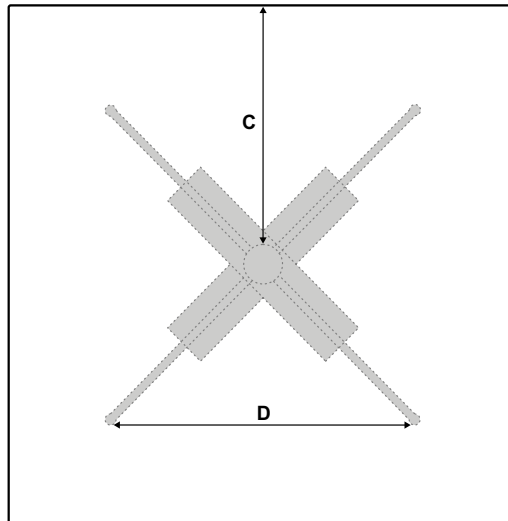
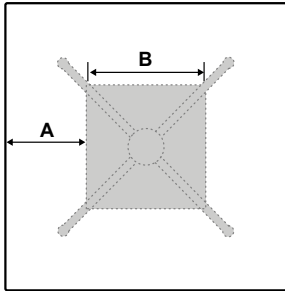

Top	A	B	C	D
30"	8 1/2"	13"	-	-
36"	11 1/2"	13"	-	-
42"	14 1/2"	13"	-	-
48"	17 1/2"	13"	-	-
54"	-	-	25"	32"
60"	-	-	28"	32"

Uffizi-Loop Base

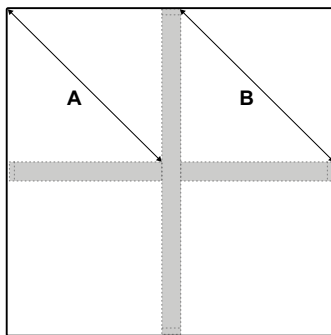

Top	A	B
30"	13"	20"
36"	16"	20"
42"	19"	26"
48"	22"	26"
54"	25"	30"
60"	28"	30"

Rectangular Kneespace

Based on the Shape and Edge Detail chosen, the following pages highlight the kneespace of each viable to Base configuration.

Coda-Vee Base

Two Bases with Center Base

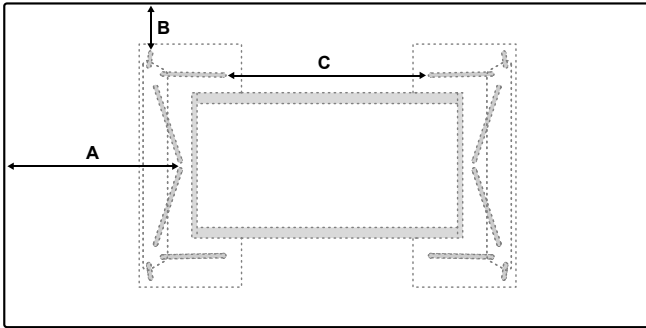

Top	A	B	C
36" x 72"	19"	5 1/2"	23 1/2"
39" x 78"	19"	7"	29 1/2"
42" x 84"	19"	8 1/2"	35 1/2"
48" x 90"	19"	11 1/2"	41 1/2"
48" x 96"	19"	11 1/2"	47 1/2"
48" x 108"	19"	11 1/2"	59 1/2"
52" x 120"	19"	13 1/2"	71 1/2"

Two Bases with Center Base

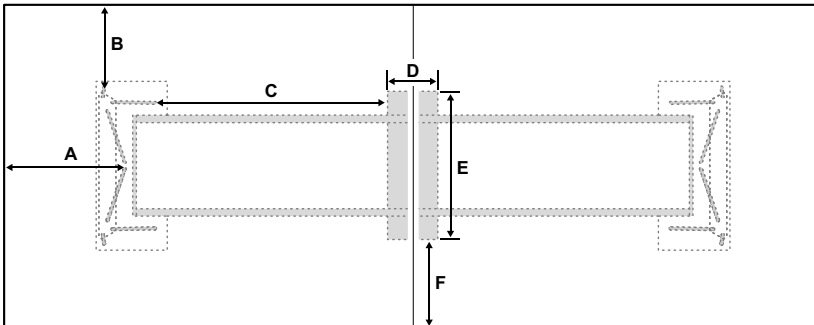

Top	A	B	C	D	E	F
52" x 132"	19"	13 1/2"	38"	8"	24"	14"
52" x 144"	19"	13 1/2"	44"	8"	24"	14"
56" x 156"	19"	15"	50"	8"	24"	16"
56" x 168"	19"	15 1/2"	56"	8"	24"	16"
56" x 180"	19"	15 1/2"	62"	8"	24"	16"
60" x 192"	19"	15 1/2"	68"	8"	24"	16 1/2"
56" x 204"	19"	17 1/2"	74"	8"	24"	16 1/2"
56" x 216"	19"	17 1/2"	80"	8"	24"	16 1/2"
60" x 240"	19"	15 1/2"	92"	8"	24"	16 1/2"

Coda-Wire Base

Two Bases

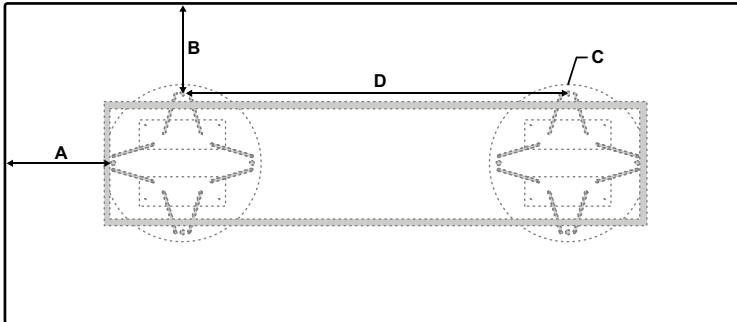

Top	A	B	C	D
36" x 72"	11"	6 ½"	25 ½"	24"
39" x 78"	11"	8"	25 ½"	30"
42" x 84"	11"	9 ½"	25 ½"	36"
48" x 90"	17"	12 ½"	25 ½"	30"
48" x 96"	17"	12 ½"	25 ½"	36"
48" x 108"	17"	12 ½"	25 ½"	48"
52" x 120"	17"	14 ½"	25 ½"	60"
52" x 132"	17"	14 ½"	25 ½"	72"
52" x 144"	17"	14 ½"	25 ½"	84"

Two Bases with Center Base

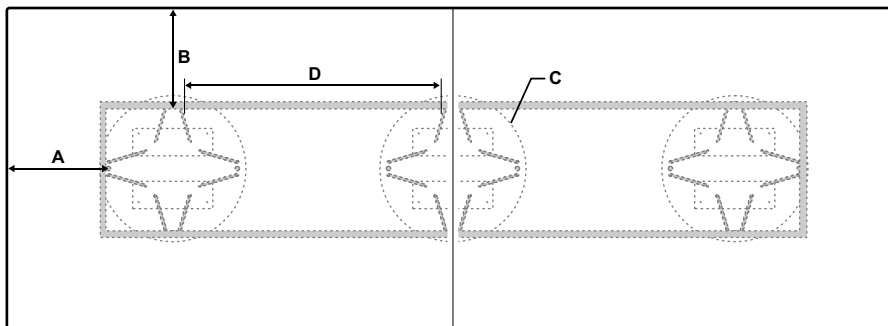

Top	A	B	C	D
56" x 156"	17"	16 ½"	25 ½"	46 1/2"
56" x 168"	17"	16 ½"	25 ½"	52 1/2"
56" x 180"	17"	16 ½"	25 ½"	58 1/2"
60" x 192"	17"	18 ½"	25 ½"	64 1/2"
60" x 204"	17"	18 ½"	25 ½"	70 1/2"
60" x 216"	17"	18 ½"	25 ½"	76 1/2"
60" x 240"	17"	18 ½"	25 ½"	88 1/2"

Coda-X Base

Two Bases

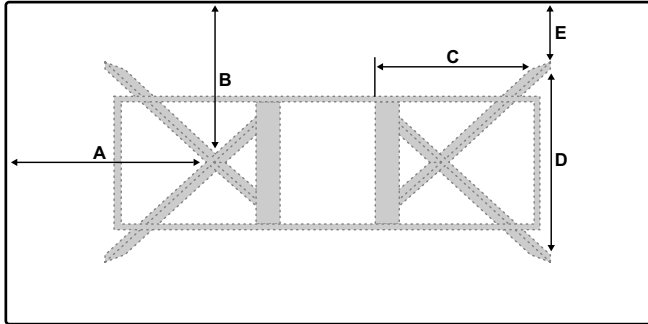

Top	A	B	C	D	E
36" x 72"	21"	16 1/2"	22 1/2"	27 1/2"	3"
39" x 78"	24"	18"	22 1/2"	27 1/2"	4 1/2"
42" x 84"	27"	19 1/2"	22 1/2"	27 1/2"	6"
48" x 90"	30"	22 1/2"	22 1/2"	27 1/2"	9"
48" x 96"	30"	22 1/2"	22 1/2"	27 1/2"	9"
48" x 108"	30"	22 1/2"	22 1/2"	27 1/2"	9"
52" x 120"	30"	22 1/2"	22 1/2"	27 1/2"	11"

Two Bases with Center Base

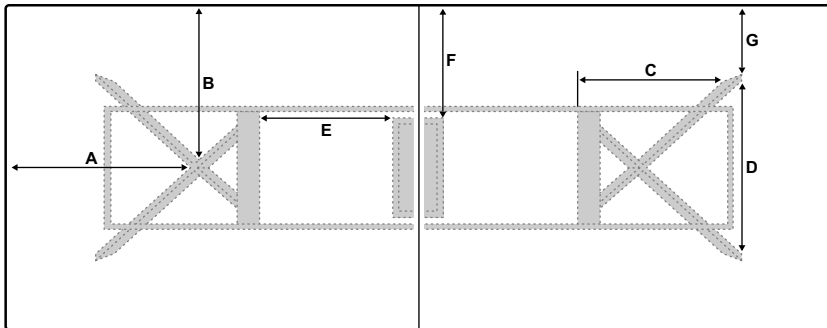

Top	A	B	C	D	E	F	G
52" x 132"	30"	24 1/2"	22 1/2"	27 1/2"	21"	18"	11"
52" x 144"	30"	24 1/2"	22 1/2"	27 1/2"	27"	18"	11"
56" x 156"	30"	26 1/2"	22 1/2"	27 1/2"	33"	20"	13"
56" x 168"	30"	26 1/2"	22 1/2"	27 1/2"	39"	20"	13"
56" x 180"	30"	26 1/2"	22 1/2"	27 1/2"	45"	20"	13"
60" x 192"	30"	28 1/2"	22 1/2"	27 1/2"	51"	22"	15"

Coda-X Base

Four Bases With Center Base

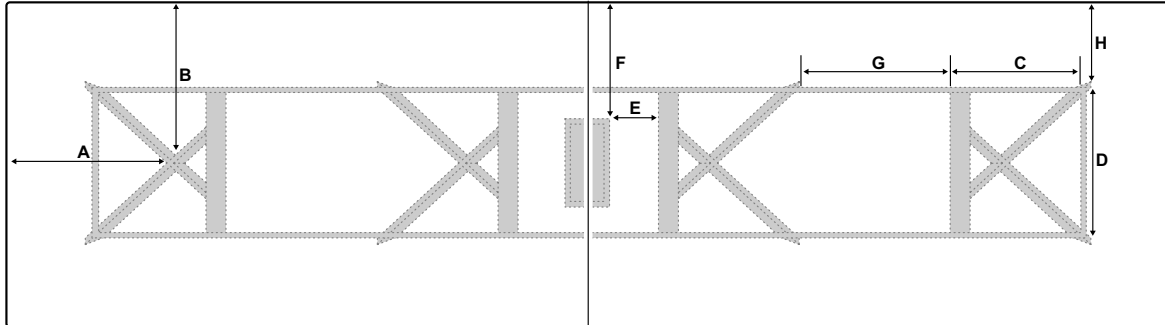

Top	A	B	C	D	E	F	G
60" x 204"	30"	22 ½"	28 ½"	27 ½"	9"	22"	15"
60" x 216"	30"	22 ½"	28 ½"	27 ½"	9"	22"	15"
60" x 240"	30"	22 ½"	28 ½"	27 ½"	15"	22"	15"

Cylinder Base

Two Bases

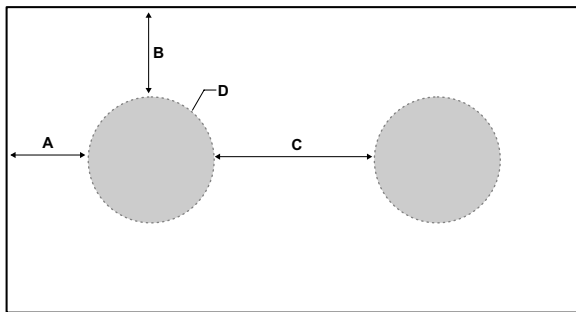

Top	A	B	C	D
48" x 90"	12 ½"	14"	25"	20"
48" x 96"	14"	14"	28"	20"
48" x 108"	17"	14"	34"	20"
52" x 120"	18"	14"	36"	24"

Cylinder Base

Two Bases with Center Base

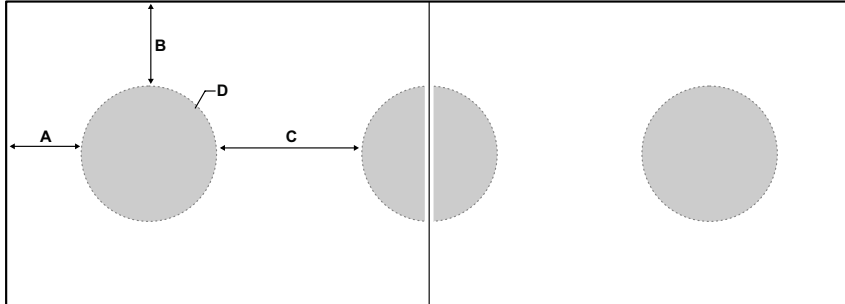

Top	A	B	C	D
52" x 132"	10"	14"	20"	24"
52" x 144"	12"	14"	24"	24"
56" x 156"	14"	16"	28"	24"
56" x 168"	16"	16"	32"	24"
56" x 180"	18"	16"	36"	24"
60" x 192"	17"	15"	34"	30"

Four Bases

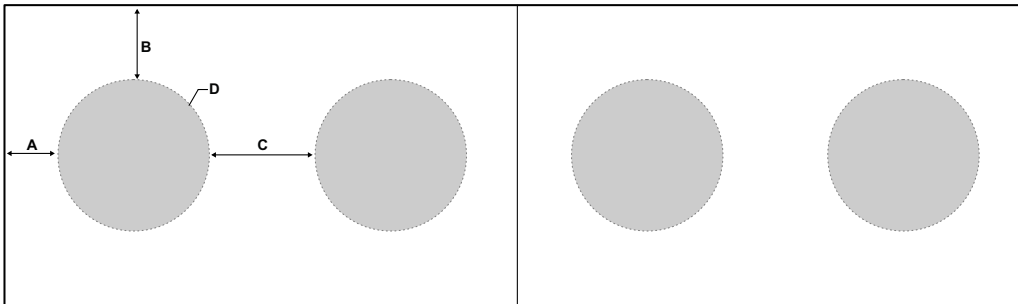

Top	A	B	C	D
60" x 204"	10 1/2"	15"	21"	30"
60" x 216"	12"	15"	24"	30"
60" x 240"	15"	15"	30"	30"

Plinth Base

Single Base

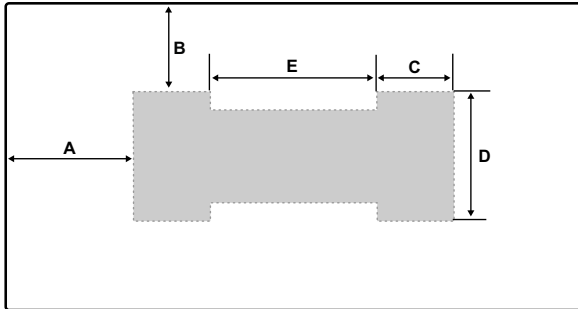

Top	A	B	C	D	E
48" x 90"	20"	14"	12"	20"	26"
48" x 96"	20"	14"	12"	20"	32"
48" x 108"	20"	14"	12"	20"	44"
52" x 120"	20"	14"	12"	24"	56"

Two Bases with Center Base

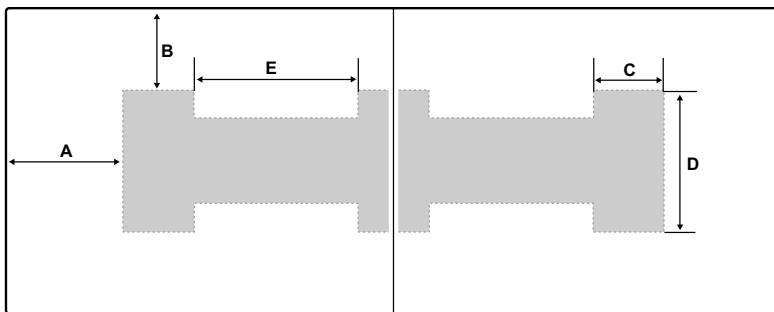

Top	A	B	C	D	E
52" x 132"	20"	14"	12"	24"	28"
52" x 144"	20"	14"	12"	24"	34"
56" x 156"	20"	16"	12"	24"	40"
56" x 168"	20"	16"	12"	24"	46"
56" x 180"	20"	16"	12"	24"	52"
60" x 192"	20"	16"	12"	28"	58"

Plinth Base

Four Bases

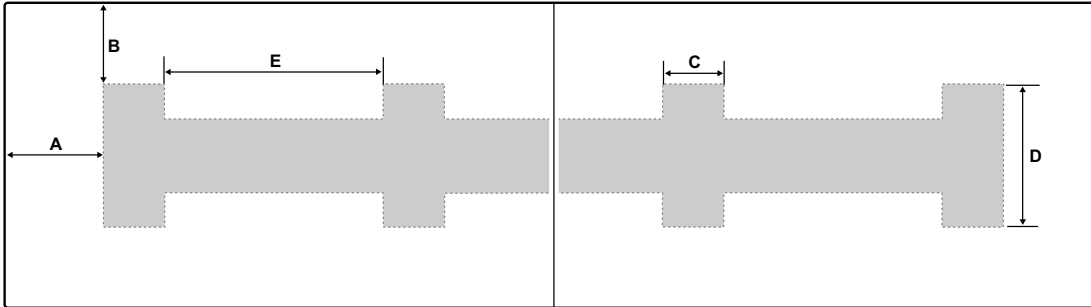

Top	A	B	C	D	E
60" x 204"	19 1/2"	16"	12"	28"	39"
52" x 216"	19 1/2"	16"	12"	28"	43"
56" x 240"	19 1/2"	16"	12"	28"	51"

Ryvit Base

Single Base

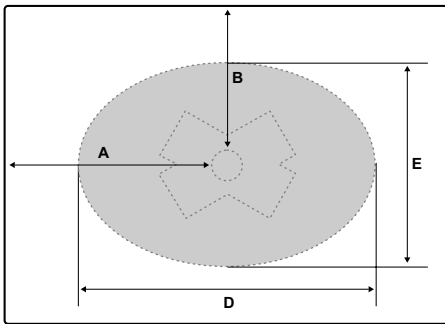

Top	A	B	C	D	E	F
30" x 42"	19 1/2"	13 1/2"	-	28"	19"	-
30" x 60"	28"	13"	-	32"	22"	-

Ryvit Base

Two Bases

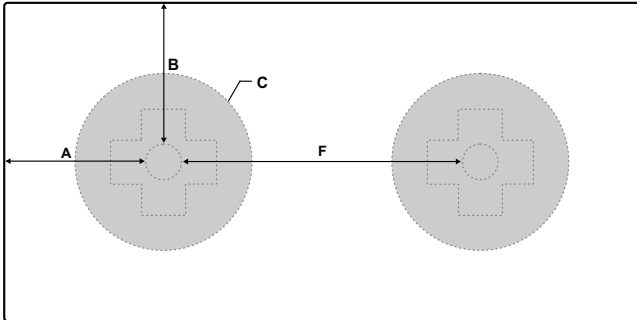

Top	A	B	C	D	E	F
36" x 72"	16"	16"	20"	-	-	32"
39" x 78"	17 1/2"	17 1/2"	20"	-	-	35"
42" x 84"	19"	19"	20"	-	-	38"
48" x 90"	20 1/2"	22"	26"	-	-	41"
48" x 96"	22"	22"	26"	-	-	44"
48" x 108"	25"	22"	26"	-	-	50"
52" x 120"	28"	24"	26"	-	-	55"

Two Bases with Center Base

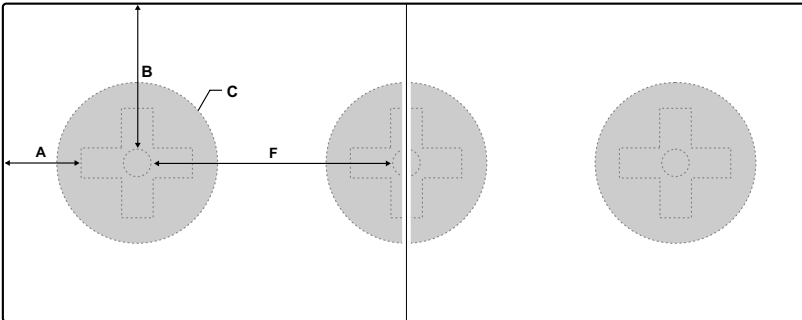

Top	A	B	C	D	E	F
52" x 132"	20"	24"	26"	-	-	40"
52" x 144"	22"	24"	26"	-	-	44"
56" x 156"	24"	26"	26"	-	-	48"
56" x 168"	26"	26"	26"	-	-	52"
56" x 180"	28"	26"	26"	-	-	56"
60" x 192"	30"	28"	30"	-	-	60"

Ryvit Base

Four Bases

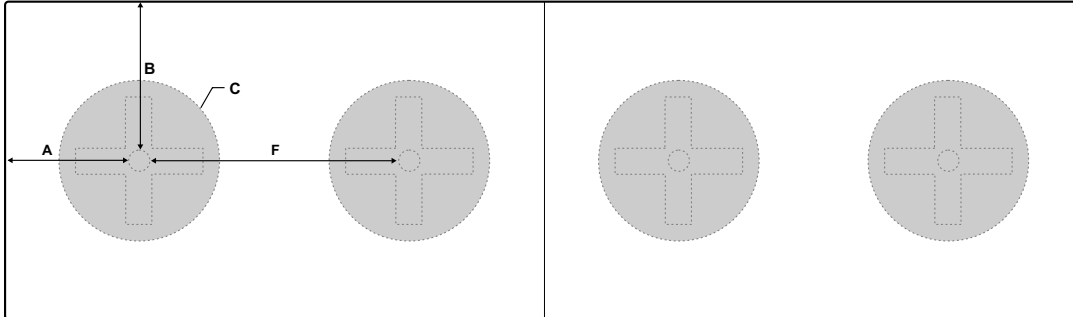

Top	A	B	C	D	E	F
52" x 132"	20"	24"	26"	-	-	40"
52" x 144"	22"	24"	26"	-	-	44"
56" x 156"	24"	26"	26"	-	-	48"
56" x 168"	26"	26"	26"	-	-	52"
56" x 180"	28"	26"	26"	-	-	56"

Spyda-T Base

Two Bases with Center Base

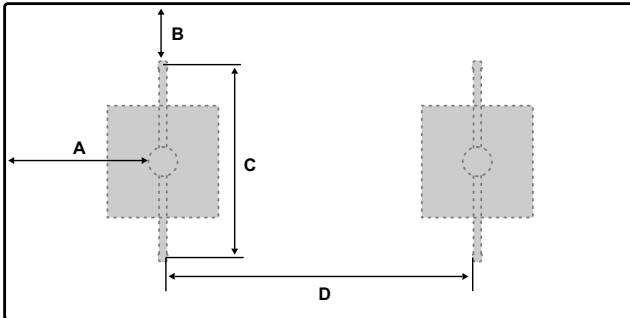

Top	A	B	C	D
36" x 72"	17 1/2"	6 1/2"	22"	35 1/2"
39" x 78"	19"	8"	22"	38 1/2"
42" x 84"	20 1/2"	9 1/2"	22"	41 1/2"
48" x 90"	22"	10 1/2"	26"	44 1/2"
48" x 96"	23 1/2"	10 1/2"	26"	47 1/2"
48" x 108"	26 1/2"	10 1/2"	26"	53 1/2"

Spyda-T Base

Two Bases with Center Base

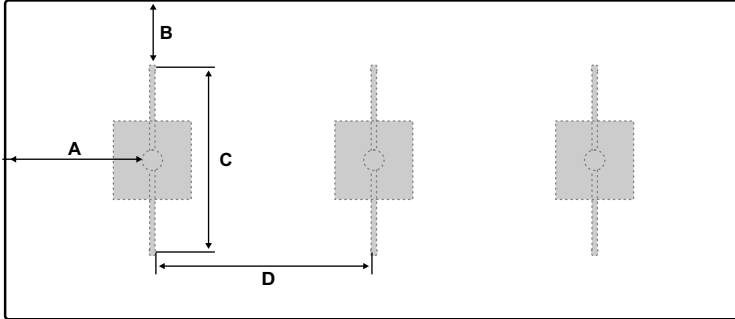

Top	A	B	C	D
52" x 120"	23 1/2"	10 1/2"	30"	35 1/2"
52" x 132"	21 1/2"	10 1/2"	30"	43"
52" x 144"	23 1/2"	10 1/2"	30"	47"
56" x 156"	25 1/2"	12 1/2"	30"	51"
56" x 168"	27 1/2"	12 1/2"	30"	55"
56" x 180"	29 1/2"	12 1/2"	30"	59"

Four Bases

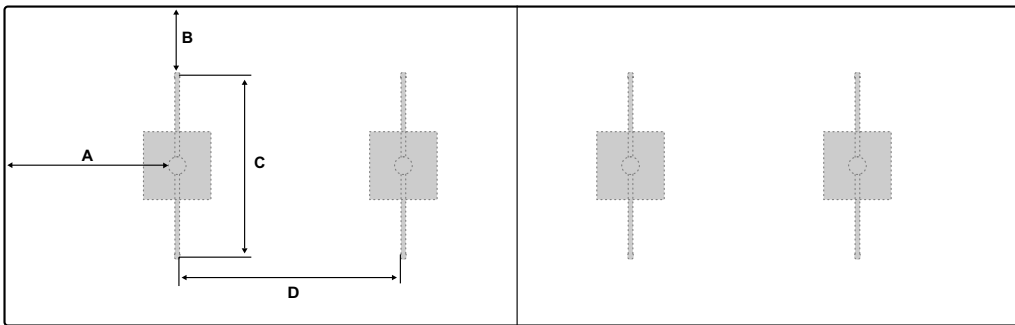

Top	A	B	C	D
60" x 192"	31 1/2"	12 1/2"	34"	42"
60" x 204"	25"	12 1/2"	34"	50 1/2"
60" x 216"	26 1/2"	12 1/2"	34"	53 1/2"
60" x 240"	29 1/2"	12 1/2"	34"	59 1/2"

Spyda-X Base

Single Base

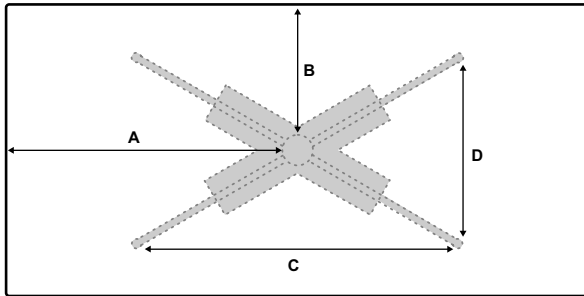

Top	A	B	C	D
30" x 42"	19"	14 1/2"	25"	14"
30" x 60"	27"	13"	28 1/2"	16"
36" x 72"	34"	16"	39"	22"
39" x 78"	38"	17 1/2"	39"	22"
42" x 84"	40"	19"	39"	22"

Two Bases

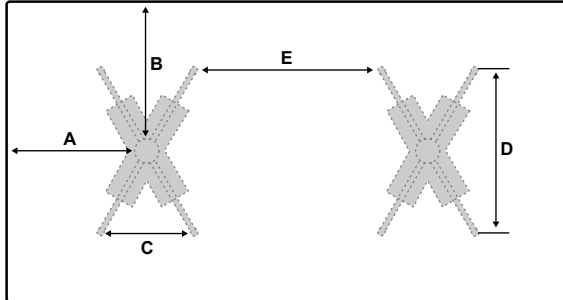

Top	A	B	C	D	E
48" x 90"	20-1/2"	22"	14"	26"	29"
48" x 96"	22"	22"	14"	26"	32"
48" x 108"	25"	22"	14"	26"	38"
52" x 120"	28"	24"	16"	29 1/2"	42"

Spyda-X Base

Two Bases with Center Base

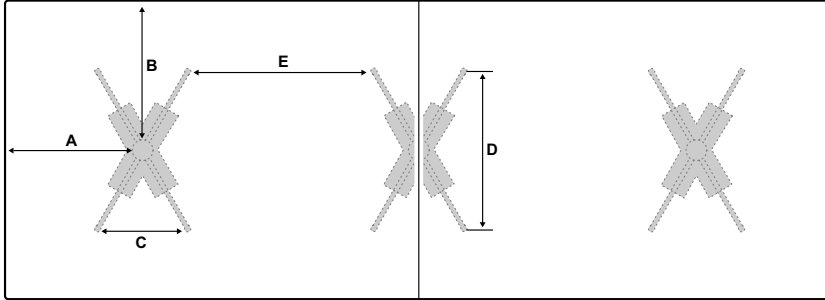

Top	A	B	C	D	E
52" x 132"	20"	24"	16"	29 ½"	26"
52" x 144"	22"	24"	17"	29 ½"	30"
56" x 156"	24"	26"	16"	29 ½"	34"
56" x 168"	26"	26"	16"	29 ½"	38"
56" x 180"	28"	26"	16"	29 ½"	42"

Four Bases

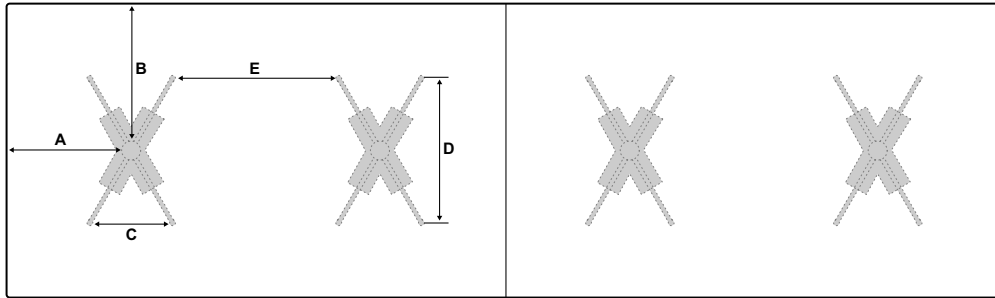

Top	A	B	C	D	E
56" x 180"	28"	26"	16"	29 ½"	42"
60" x 192"	30"	28"	16"	29 ½"	46"
60" x 204"	23 ½"	28"	16"	29 ½"	33"
60" x 216"	25"	28"	16"	29 ½"	36"
60" x 240"	28"	28"	16"	29 ½"	42"

Spyda-Y Base

Two Bases

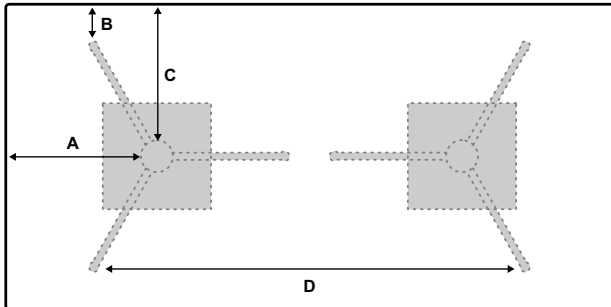

Top	A	B	C	D
36" x 72"	17 1/2"	4 1/2"	17 1/2"	50 1/2"
39" x 78"	19"	4 1/2"	19"	53 1/2"
42" x 84"	20 1/2"	4 1/2"	20 1/2"	56 1/2"
48" x 90"	22"	10 1/2"	23 1/2"	59 1/2"
48" x 96"	23 1/2"	10 1/2"	23 1/2"	62 1/2"
48" x 108"	26 1/2"	10 1/2"	23 1/2"	68 1/2"
52" x 120"	29 1/2"	10 1/2"	25 1/2"	76 1/2"

Two Bases with Center Base

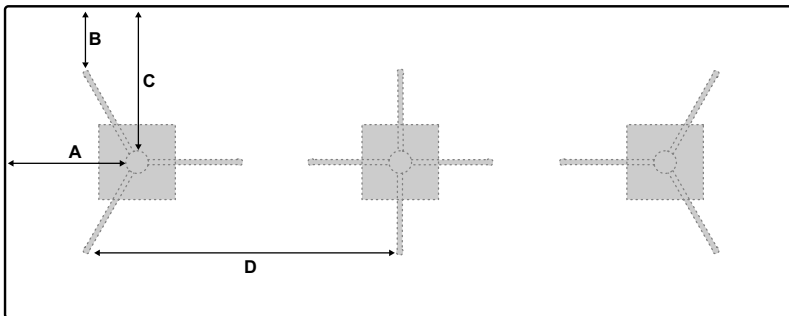

Top	A	B	C	D
52" x 132"	21 1/2"	10 1/2"	25 1/2"	51 1/2"
52" x 144"	23 1/2"	10 1/2"	25 1/2"	55 1/2"
56" x 156"	25 1/2"	12 1/2"	27 1/2"	59 1/2"
56" x 168"	27 1/2"	13"	27 1/2"	63 1/2"
56" x 180"	29 1/2"	12 1/2"	27 1/2"	67 1/2"

Spyda-Y Base

Four Bases

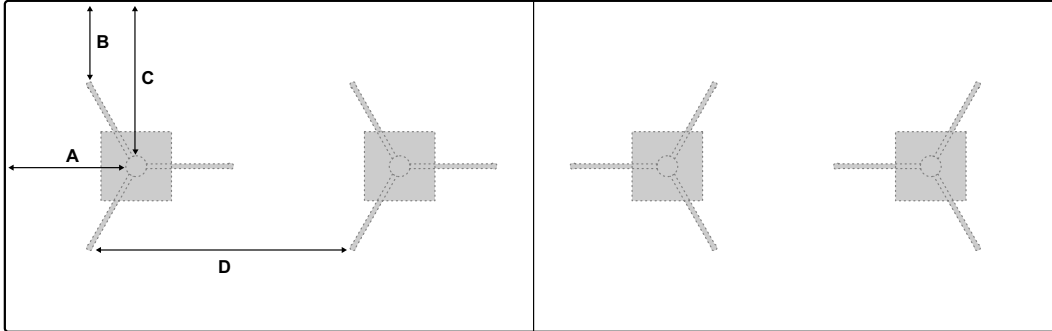

Top	A	B	C	D
60" x 192"	23 1/2"	14 1/2"	29 1/2"	47"
60" x 204"	25"	14 1/2"	29 1/2"	50"
60" x 216"	26 1/2"	15"	29 1/2"	53"
60" x 240"	29 1/2"	14 1/2"	29 1/2"	59"

Uffizi-Loop Base

Single Base

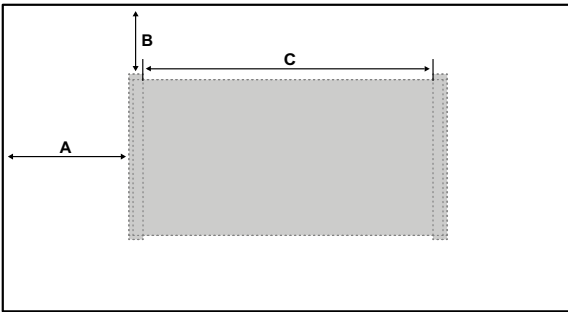

Top	A	B	C
48" x 90"	20"	11"	45"
48" x 96"	20"	11"	51"
48" x 108"	20"	11"	63"
52" x 120"	20"	13"	75"

Uffizi-Loop Base

Single Base with Center Base

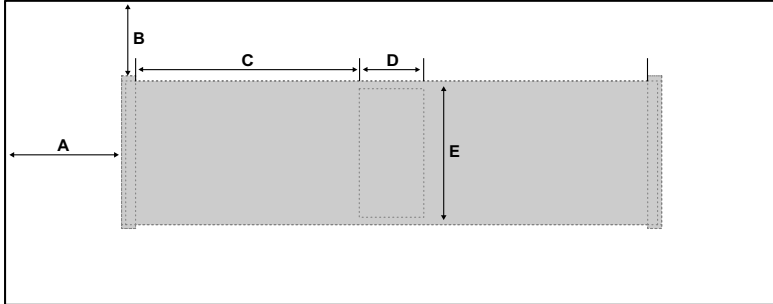

Top	A	B	C	D	E
52" x 132"	20"	13"	38"	11"	22"
52" x 144"	20"	13"	44"	11"	22"
56" x 156"	20"	15"	50"	11"	22"
56" x 168"	20"	15"	56"	11"	22"
56" x 180"	20"	15"	62"	11"	22"
60" x 192"	20"	15"	68"	11"	26"
60" x 204"	20"	15"	74"	11"	26"
60" x 216"	20"	15"	80"	11"	26"
60" x 240"	20"	15"	92"	11"	26"

Zi-A Base

Single Base

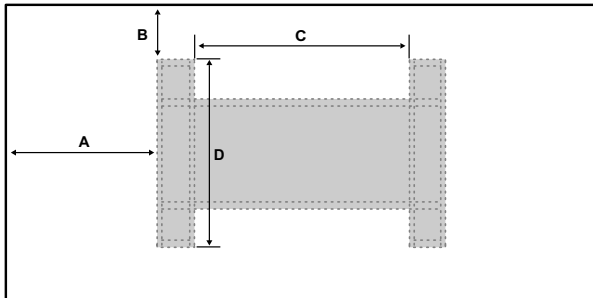

Top	A	B	C	D
39" x 78"	20"	7 ½"	29"	24 ½"
42" x 84"	20"	9"	35"	24 ½"
48" x 90"	20"	12"	41"	24 ½"
48" x 96"	20"	12"	47"	24 ½"
48" x 108"	20"	12"	59"	24 ½"
52" x 120"	20"	12 ½"	71"	27 ½"

Zi-A Base

Single Base with Center Base

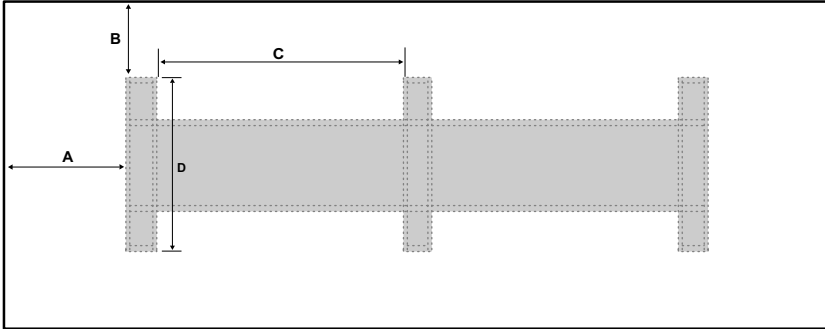

Top	A	B	C	D
52" x 132"	20"	12 1/2"	39 1/2"	27 1/2"
52" x 144"	20"	12 1/2"	44 1/2"	27 1/2"
56" x 156"	20"	13"	51 1/2"	30 1/2"
56" x 168"	20"	13"	57 1/2"	30 1/2"
56" x 180"	20"	13"	63 1/2"	30 1/2"
60" x 192"	20"	15"	69 1/2"	30 1/2"

Four Bases

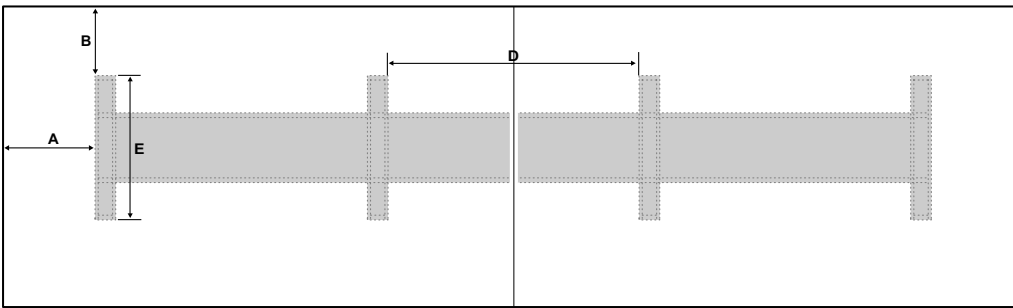

Top	A	B	C	D	E
60" x 204"	19 1/2"	15"	49"	49"	30 1/2"
60" x 216"	19 1/2"	15"	49"	53"	30 1/2"
60" x 240"	19 1/2"	15"	92"	61"	30 1/2"

Zi-D Base

Single Base

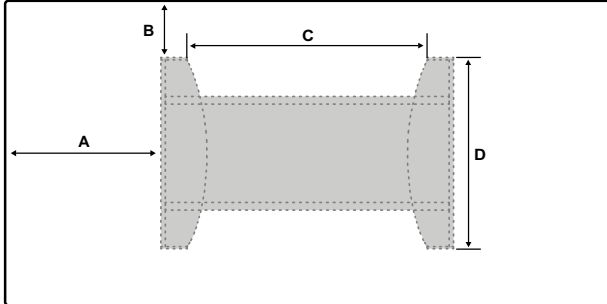

Top	A	B	C	D
39" x 78"	20"	7 1/2"	29"	24 1/2"
42" x 84"	20"	9"	35"	24 1/2"
48" x 90"	20"	12"	41"	24 1/2"
48" x 96"	20"	12"	47"	24 1/2"
48" x 108"	20"	12"	59"	24 1/2"
52" x 120"	20"	12 1/2"	71"	27 1/2"

Two Bases with Center Base

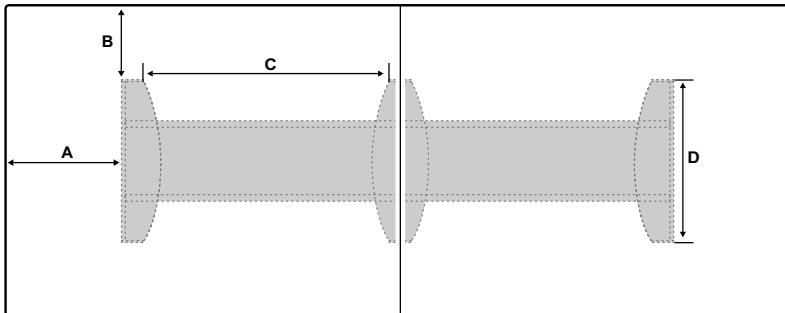

Top	A	B	C	D
52" x 132"	20"	12 1/2"	39 1/2"	27 1/2"
52" x 144"	20"	12 1/2"	44 1/2"	27 1/2"
56" x 156"	20"	13"	51 1/2"	30 1/2"
56" x 168"	20"	13"	57 1/2"	30 1/2"
56" x 180"	20"	13"	63 1/2"	30 1/2"
60" x 192"	20"	15"	69 1/2"	30 1/2"

Zi-D Base

Four Bases

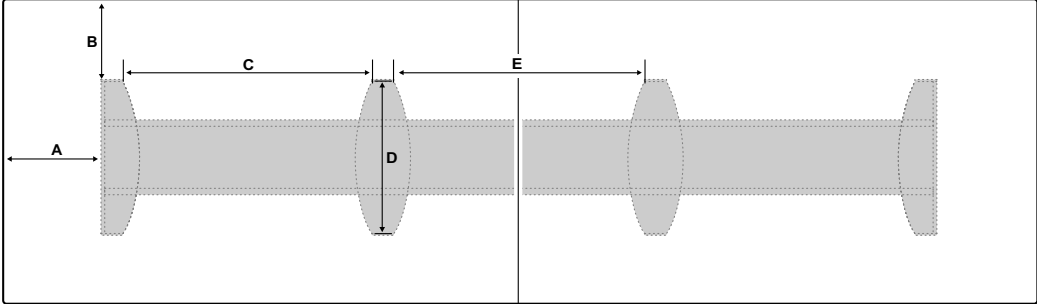

Top	A	B	C	D	E
60" x 204"	19 1/2"	15"	49"	49"	49"
60" x 216"	19 1/2"	15"	49"	53"	53"
60" x 240"	19 1/2"	15"	92"	61"	61"

Video Kneespace

Based on the Shape and Edge Detail chosen, the following pages highlight the kneespace of each viable to Base configuration.

Coda-Vee Base

Single Base

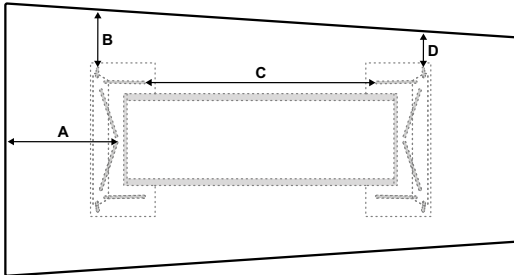

Top	A	B	C	D
36/48" x 90"	19"	10"	41 ½"	6 ½"
36/48" x 96"	19"	10 ½"	47 ½"	6 ½"
36/48" x 108"	19"	10 ½"	59 ½"	6"
40/52" x 120"	19"	12 ½"	71 ½"	8"

Two Bases with Center Base

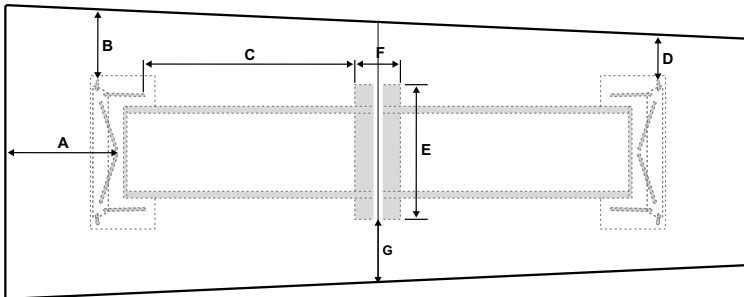

Top	A	B	C	D	E	F	G
40/52" x 132"	19"	12 ½"	37 ½"	8"	24"	8"	11"
40/52" x 144"	19"	12 ½"	43 ½"	8"	24"	8"	11"
44/56" x 156"	19"	14 ½"	49 ½"	10"	24"	8"	13"
44/56" x 168"	19"	14 ½"	55 ½"	10"	24"	8"	13"
44/56" x 180"	19"	15"	61 ½"	10"	24"	8"	13"
44/60" x 192"	19"	16 ½"	67 ½"	10"	27"	8"	12 ½"
44/60" x 204"	19"	16 ½"	73 ½"	10"	27"	8"	12 ½"
44/60" x 216"	19"	16 ½"	79 ½"	10"	27"	8"	12 ½"
44/60" x 240"	19"	17"	91 ½"	10"	27"	8"	12 ½"

Coda-Wire Base

Two Bases

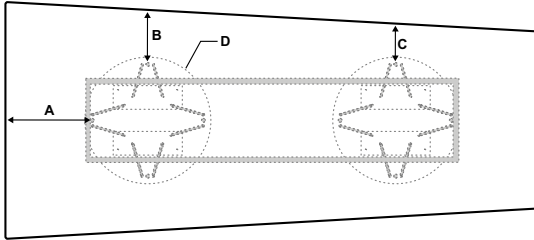

Top	A	B	C	D
36/48" x 90"	17"	10 1/2"	8 1/2"	25 1/2"
36/48" x 96"	17"	10 1/2"	8"	25 1/2"
36/48" x 108"	17"	11"	8"	25 1/2"
40/52" x 120"	17"	13"	10"	25 1/2"
40/52" x 132"	17"	13"	9 1/2"	25 1/2"
40/52" x 144"	17"	13"	9 1/2"	25 1/2"

Two Bases with Center Base

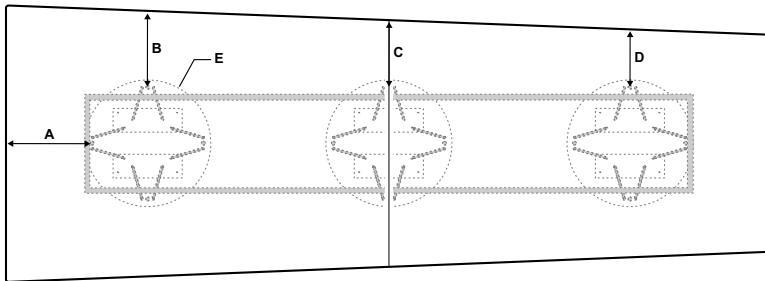

Top	A	B	C	D	E
44/56" x 156"	17"	15 1/2"	13 1/2"	11 1/2"	25 1/2"
44/56" x 168"	17"	15 1/2"	13 1/2"	11 1/2"	25 1/2"
44/56" x 180"	17"	15 1/2"	13 1/2"	11 1/2"	25 1/2"
44/60" x 192"	17"	17"	14 1/2"	11 1/2"	25 1/2"
44/60" x 204"	17"	17 1/2"	14 1/2"	11 1/2"	25 1/2"
44/60" x 216"	17"	17 1/2"	14 1/2"	11 1/2"	25 1/2"
44/60" x 240"	17"	17 1/2"	14 1/2"	11 1/2"	25 1/2"

Coda-X Base

Two Bases

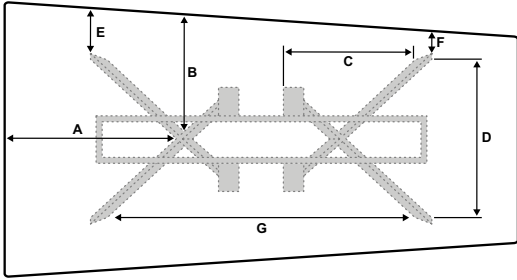

Top	A	B	C	D	E	F	G
36/48" x 90"	30"	20 ½"	22 ½"	27 ½"	8"	4"	53 ½"
36/48" x 96"	30"	20 ½"	22 ½"	27 ½"	8"	4"	59 ½"
36/48" x 108"	30"	20 ½"	22 ½"	27 ½"	8"	4"	71 ½"
40/52" x 120"	30"	20 ½"	23 ½"	27 ½"	10 ½"	6"	83 ½"

Two Bases with Center Base

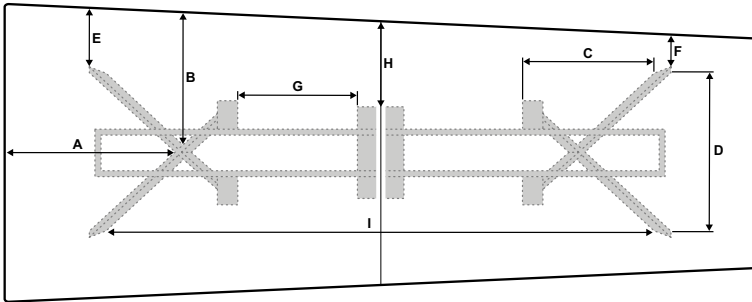

Top	A	B	C	D	E	F	G	H	I
40/52" x 132"	30"	23 ½"	22 ½"	27 ½"	10 ½"	6"	21"	15"	95 ½"
40/52" x 144"	30"	23"	22 ½"	27 ½"	10 ½"	6"	27"	15"	107 ½"
44/56" x 156"	30"	25 ½"	13 ½"	27 ½"	12 ½"	7 ½"	33"	17"	119 ½"
44/56" x 168"	30"	25 ½"	22 ½"	27 ½"	12 ½"	7 ½"	39"	17"	131 ½"
44/56" x 180"	30"	25 ½"	22 ½"	27 ½"	12 ½"	6"	45"	17"	143 ½"
44/60" x 192"	30"	27"	22 ½"	27 ½"	14 ½"	7 ½"	51"	18"	155 ½"
44/60" x 204"	30"	27"	22 ½"	27 ½"	14 ½"	7 ½"	57"	18"	167 ½"
44/60" x 216"	30"	27"	22 ½"	27 ½"	14 ½"	7 ½"	63"	18"	179 ½"

Cylinder Base

Two Bases

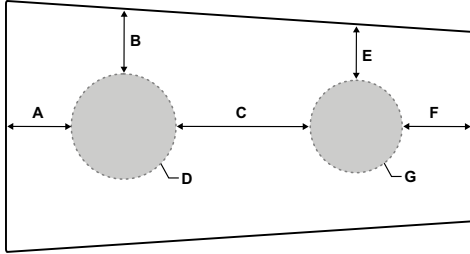

Top	A	B	C	D	E	F	G
36/48" x 90"	12 1/2"	12 1/2"	26"	20"	10 1/2"	13 1/2"	18"
36/48" x 96"	14"	12 1/2"	29"	20"	10 1/2"	15"	18"
36/48" x 108"	17"	12 1/2"	35"	20"	10 1/2"	18"	18"
40/52" x 120"	20"	14 1/2"	41"	20"	12 1/2"	21"	18"

Two Bases with Center Base

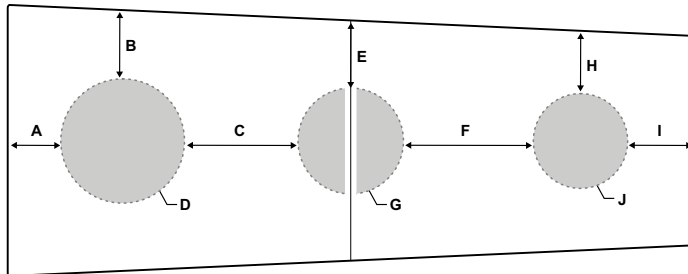

Top	A	B	C	D	E	F	G	H	I	J
40/52" x 132"	10"	13"	22"	24"	13"	25"	20"	12"	13"	18"
40/52" x 144"	12"	13"	26"	24"	13"	29"	20"	12"	15"	18"
44/56" x 156"	11"	12"	25"	30"	13"	30"	24"	13"	16"	20"
44/56" x 168"	13"	12"	29"	30"	13"	34"	24"	13"	18"	20"
44/56" x 180"	15"	12"	33"	30"	13"	38"	24"	13"	20"	20"
44/60" x 192"	18"	14 1/2"	38"	30"	14"	42"	24"	13 1/2"	22"	20"

Cylinder Base

Four Bases

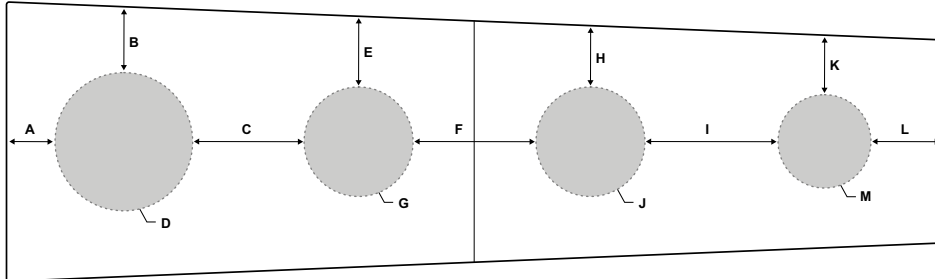

Top	A	B	C	D	E	F	G	H	I	J	K	L	M
44/60" x 204"	10 1/2"	14"	24"	30"	15"	27"	24"	13"	29"	24"	13"	15 1/2"	20"
44/60" x 216"	12"	14"	27"	30"	15"	30"	24"	13"	32"	24"	13"	17"	20"
44/60" x 204"	12"	14"	33"	30"	15"	36"	24"	13"	38"	24"	13"	17"	20"

Plinth Base

Two Bases

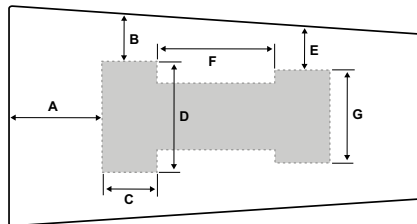

Top	A	B	C	D	E	F	G
36/48" x 90"	20"	10 1/2"	12"	24"	9 1/2"	26"	20"
36/48" x 96"	20"	10 1/2"	12"	24"	9 1/2"	32"	20"
36/48" x 108"	20"	10 1/2"	12"	24"	9 1/2"	44"	20"
40/52" x 120"	20"	12 1/2"	12"	24"	11 1/2"	56"	20"

Plinth Base

Two Bases with Center Base

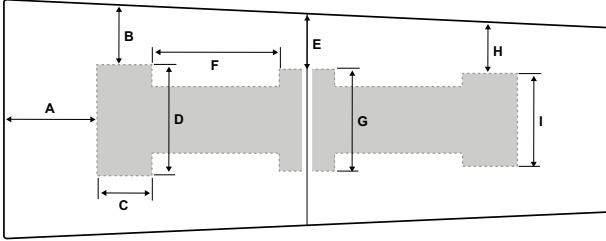

Top	A	B	C	D	E	F	G	H	I
40/52" x 132"	20"	13"	12"	24"	12"	28"	22"	11"	20"
40/52" x 144"	20"	13"	12"	24"	12"	34"	22"	11"	20"
44/56" x 156"	20"	15"	12"	24"	14"	40"	22"	13"	20"
44/56" x 168"	20"	13"	12"	24"	14"	46"	22"	13"	20"
44/56" x 180"	20"	15"	12"	22"	14"	52"	22"	13"	20"
44/60" x 192"	20"	15"	12"	28"	15"	58"	22"	13"	20"

Four Bases

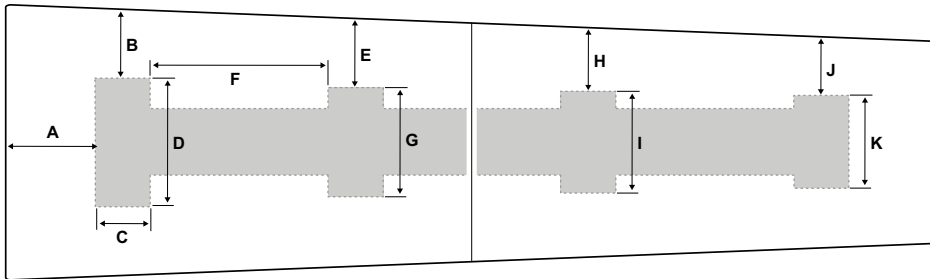

Top	A	B	C	D	E	F	G	H	I	J	K
44/60" x 204"	19 1/2"	15"	12"	28"	15"	39"	24"	14"	22"	13"	20"
44/60" x 216"	19 1/2"	15"	12"	28"	15"	43"	24"	14"	22"	13"	20"
44/60" x 204"	19 1/2"	15"	12"	28"	15"	51"	24"	14"	22"	13"	20"

Ryvit Base

Two Bases

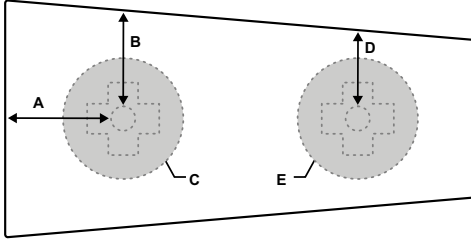

Top	A	B	C	D	E
26/39" x 78"	17 1/2"	16"	20"	12 1/2"	20"
28/42" x 84"	19"	17 1/2"	20"	14"	20"
36/48" x 90"	20 1/2"	20 1/2"	26"	17 1/2"	20"
36/48" x 96"	22"	20 1/2"	26"	17 1/2"	20"
36/48" x 108"	25"	20 1/2"	26"	17 1/2"	20"
40/52" x 120"	28"	22 1/2"	26"	19 1/2"	20"

Two Bases with Center Base

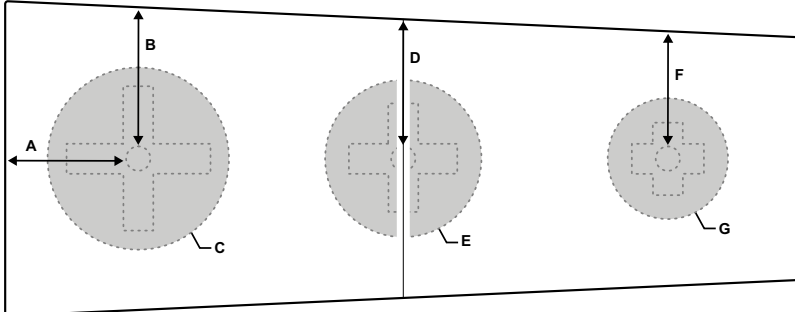

Top	A	B	C	D	E	F	G
40/52" x 132"	20"	23"	30"	21"	26"	19"	20"
40/52" x 144"	22"	23"	30"	21"	26"	19"	20"
44/56" x 156"	24"	25"	30"	23"	26"	21"	20"
44/56" x 168"	26"	25"	30"	23"	26"	21"	20"
44/56" x 180"	28"	25"	30"	23"	26"	21"	20"
44/60" x 192"	30"	26 1/2"	30"	24"	26"	21 1/2"	20"

Ryvit Base

Four Bases

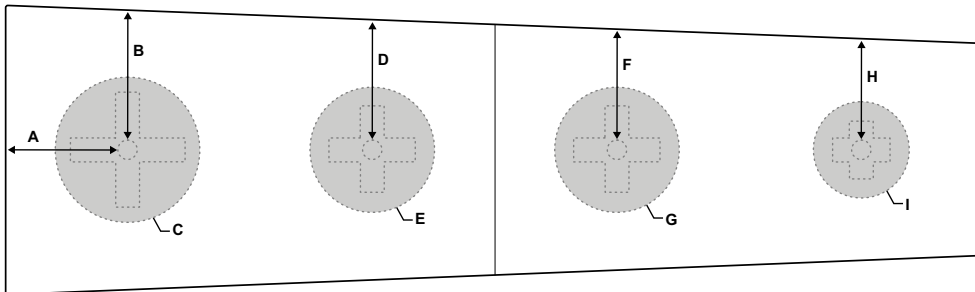

Top	A	B	C	D	E	F	G	H	I
44/60" x 204"	23 1/2"	27"	30"	25"	26"	23"	26"	21"	20"
44/60" x 216"	25"	27"	30"	25"	26"	23"	26"	21"	20"
44/60" x 204"	28"	27"	30"	25"	26"	23"	26"	21"	20"

Spyda-T Base

Two Bases

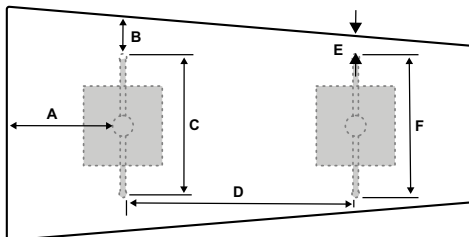

Top	A	B	C	D	E	F	G
26/39" x 78"	19"	6 1/2"	22"	38"	3"	22"	14"
28/42" x 84"	20 1/2"	7 1/2"	22"	41"	4"	22"	14"
36/48" x 90"	22"	9"	26"	44"	8"	22"	14"
36/48" x 96"	23"	9"	26"	47"	8"	22"	14"
36/48" x 108"	26 1/2"	9"	26"	53"	8"	22"	14"

Spyda-T Base

Two Bases with Center Base

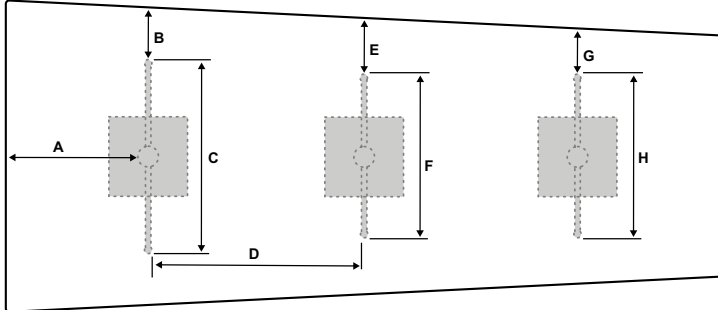

Top	A	B	C	D	E	F	G	H
40/52" x 120"	23 1/2"	9"	30"	35"	9 1/2"	26"	7 1/2"	26"
40/52" x 132"	21 1/2"	9 1/2"	30"	43"	9 1/2"	26"	9 1/2"	22"
40/52" x 144"	23 1/2"	9 1/2"	30"	47"	9 1/2"	26"	9 1/2"	22"
44/56" x 156"	25 1/2"	11 1/2"	30"	51"	1 1/2"	26"	11 1/2"	22"
44/56" x 168"	27 1/2"	11 1/2"	30"	55"	11 1/2"	26"	11 1/2"	22"
44/56" x 180"	29 1/2"	11 1/2"	30"	59"	11 1/2"	26"	11 1/2"	22"

Four Bases

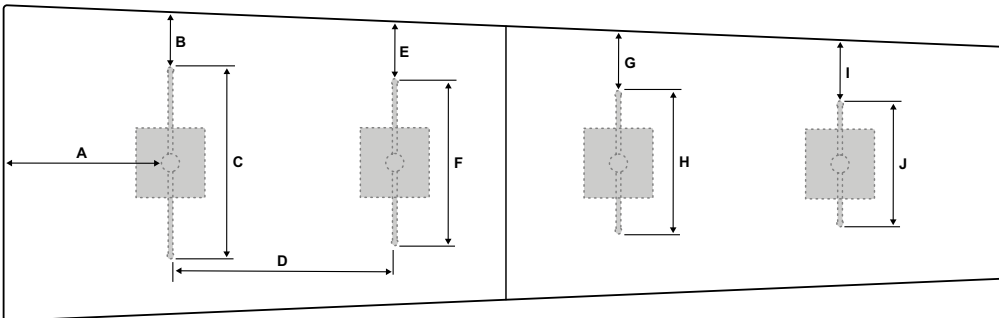

Top	A	B	C	D	E	F	G	H	I
44/60" x 192"	31 1/2"	11"	34"	41 1/2"	11 1/2"	30"	11 1/2"	26"	22"
44/56" x 156"	25"	11 1/2"	34"	50"	11 1/2"	30"	11 1/2"	26"	22"
44/56" x 168"	26 1/2"	11 1/2"	34"	53"	11 1/2"	30"	11 1/2"	26"	22"
44/56" x 180"	29 1/2"	11 1/2"	34"	59"	11 1/2"	30"	11 1/2"	26"	22"

Spyda-X Base

Single Base

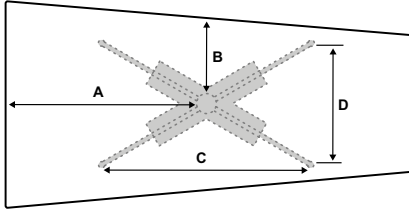

Top	A	B	C	D
26/39" x 78"	37"	14 1/2"	39 1/2"	22"
28/42" x 84"	40"	15 1/2"	39 1/2"	23"

Two Bases

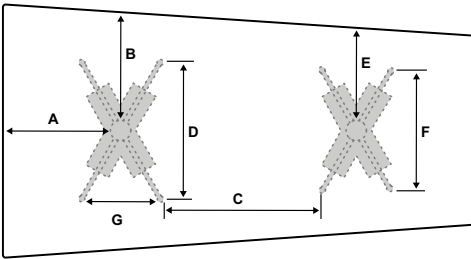

Top	A	B	C	D	E	F	G
36/48" x 90"	22"	9"	26"	44"	8"	22"	14"
36/48" x 96"	23"	9"	26"	47"	8"	22"	14"
36/48" x 108"	26 1/2"	9"	26"	53"	8"	22"	14"

Two Bases with Center Base

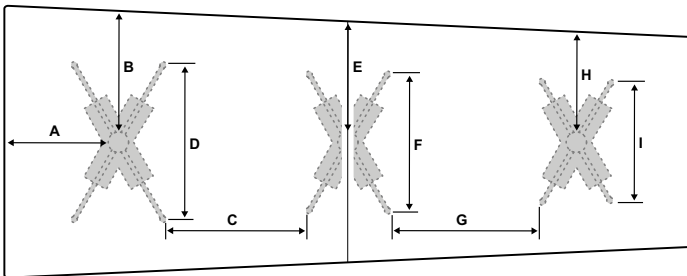

Top	A	B	C	D	E	F	G	H	I
40/52" x 132"	20"	23"	27 1/2"	30"	21"	26 1/2"	29"	19"	22 1/2"
40/52" x 144"	22"	23"	31"	29 1/2"	21"	26"	33"	19"	22 1/2"
44/56" x 156"	24"	25"	35"	29 1/2"	23"	26"	37"	21"	22 1/2"
44/56" x 168"	26"	25"	39"	29 1/2"	23"	26"	40 1/2"	21"	22 1/2"
44/56" x 180"	28"	25"	43"	29 1/2"	23"	26"	45"	21"	22 1/2"
44/60" x 192"	30"	26 1/2"	47"	29 1/2"	24"	26 1/2"	49"	21 1/2"	22 1/2"

Spyda-X Base

Four Bases

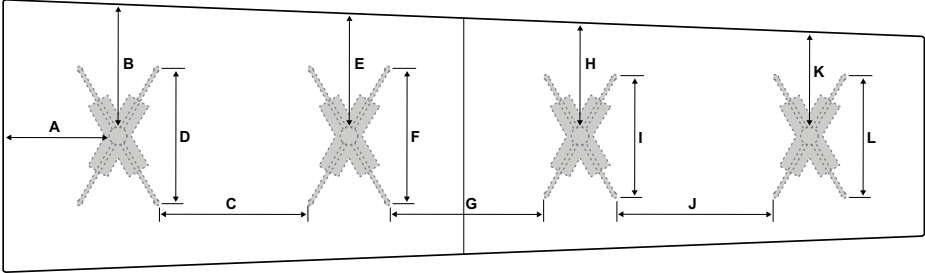

Top	A	B	C	D	E	F	G	H	I	J	K
44/60" x 204"	23 1/2"	27"	33"	29 1/2"	25"	29 1/2"	34"	23"	26 1/2"	35"	26"
44/60" x 216"	25"	27"	36"	29 1/2"	25"	29 1/2"	37"	23"	26"	38"	26"
44/60" x 240"	28"	27"	42"	29 1/2"	25"	29 1/2"	43"	23"	26"	44"	26 1/2"

Spyda-Y Base

Two Bases

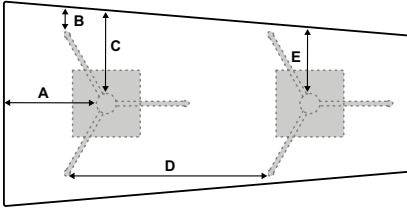

Top	A	B	C	D	E	F	G
26/39" x 78"	19"	5"	17 1/2"	38 1/2"	14"	-	-
28/42" x 84"	20 1/2"	6 1/2"	18 1/2"	41 1/2"	15 1/2"	-	-
36/48" x 90"	22"	9 1/2"	22"	44 1/2"	19"	6 1/2"	7"
36/48" x 96"	23 1/2"	9 1/2"	22"	47 1/2"	19"	6 1/2"	8 1/2"
36/48" x 108"	26 1/2"	9 1/2"	22"	53 1/2"	19"	6 1/2"	11 1/2"
40/52" x 120"	29 1/2"	9 1/2"	24"	60"	21"	8 1/2"	14 1/2"

Two Bases with Center Base

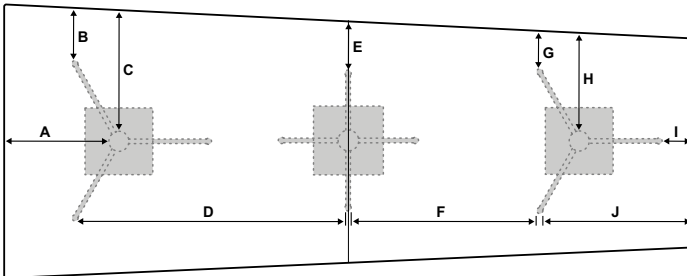

Top	A	B	C	D	E	F	G	H	I	J
40/52" x 132"	21 1/2"	10"	24 1/2"	52"	9 1/2"	35 1/2"	8"	20 1/2"	6 1/2"	29 1/2"
40/52" x 144"	23 1/2"	10"	24 1/2"	56"	9 1/2"	39 1/2"	8"	20 1/2"	8 1/2"	31 1/2"
44/56" x 156"	25 1/2"	12"	26 1/2"	60"	11 1/2"	43 1/2"	9 1/2"	22 1/2"	10 1/2"	33"
44/56" x 168"	29 1/2"	12"	26 1/2"	68"	11 1/2"	51 1/2"	10"	22 1/2"	12 1/2"	35 1/2"
44/56" x 180"	28"	25"	30"	23"	26"	21"	9 1/2"	22 1/2"	14 1/2"	37 1/2"

Spyda-Y Base

Four Bases

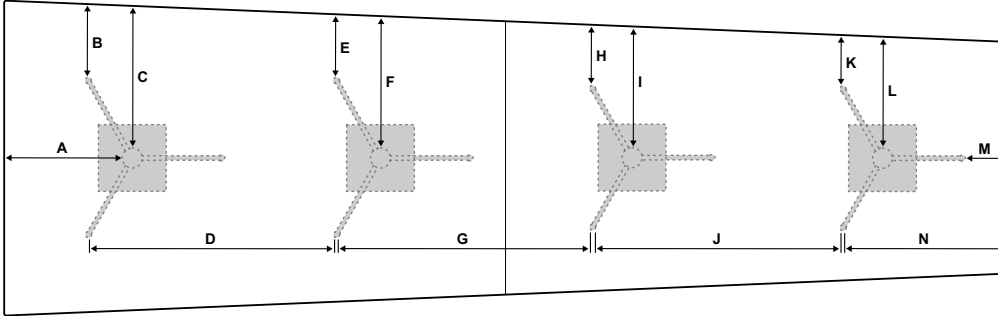

Top	A	B	C	D	E	F	G	H	I	J	K	L	M	N
44/60" x 192"	23 1/2"	14"	28 1/2"	47 1/2"	12"	26 1/2"	48 1/2"	12"	24 1/2"	47 1/2"	10"	22 1/2"	8 1/2"	31 1/2"
44/60" x 204"	25"	14"	28 1/2"	50 1/2"	12"	26 1/2"	51 1/2"	12"	24 1/2"	50 1/2"	10"	22 1/2"	10"	33"
44/60" x 216"	26 1/2"	14"	28 1/2"	53 1/2"	12"	26 1/2"	54 1/2"	12"	24 1/2"	53 1/2"	9 1/2"	22 1/2"	11 1/2"	34 1/2"
44/60" x 204"	29 1/2"	14"	28 1/2"	59 1/2"	12"	26 1/2"	60 1/2"	11 1/2"	24 1/2"	59 1/2"	9 1/2"	22 1/2"	14 1/2"	37 1/2"

Uffiz-Loop Base

Two Bases

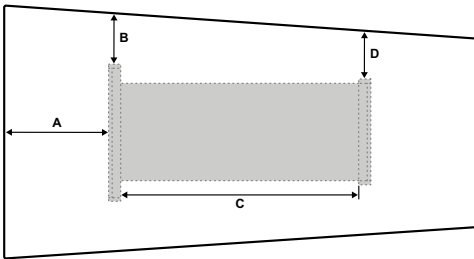

Top	A	B	C	D
36/48" x 90"	20"	9 1/2"	45"	9 1/2"
36/48" x 96"	20"	9 1/2"	51"	9 1/2"
36/48" x 108"	20"	10"	63"	9"
40/52" x 120"	20"	12"	75"	11"

Uffiz-Loop Base

Two Bases with Center Base

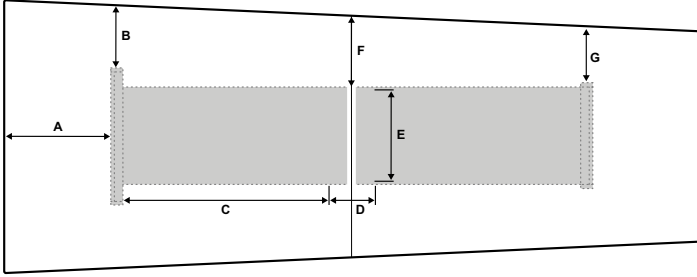

Top	A	B	C	D	E	F	G
40/52" x 132"	20"	12"	38"	11"	16"	15"	11"
40/52" x 144"	20"	12"	44"	11"	16"	15"	11"
44/56" x 156"	20"	14"	50"	11"	16"	17"	13"
44/56" x 168"	20"	14"	56"	11"	16"	17"	12 ½"
44/56" x 180"	20"	14 ½"	62"	11"	16"	17"	12 ½"
44/60" x 192"	20"	14 ½"	68"	11"	22"	15"	10"
44/60" x 204"	20"	14 ½"	74"	11"	22"	15"	10"
44/60" x 216"	20"	14 ½"	80"	11"	22"	15"	10"
44/60" x 240"	20"	14 ½"	92"	11"	22"	15"	9 ½"

ZI-A Base

Two Bases

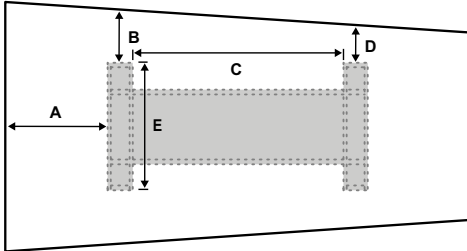

Top	A	B	C	D	E
36/48" x 90"	20"	10 1/2"	41"	7 1/2"	24 1/2"
36/48" x 96"	20"	10 1/2"	47"	7"	24 1/2"
36/48" x 108"	20"	10 1/2"	56"	7"	24"
40/52" x 120"	28"	11 1/2"	71"	9"	27"

Two Bases with Center Base

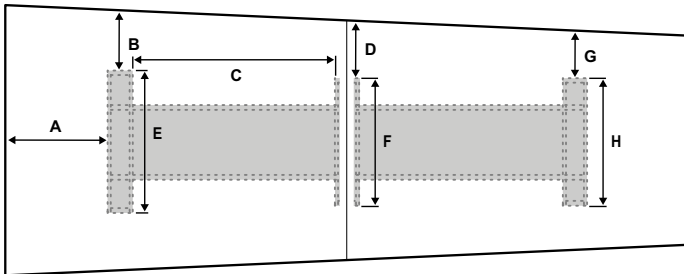

Top	A	B	C	D	E	F	G	H
40/52" x 132"	20"	11 1/2"	39 1/2"	11"	27 1/2"	24 1/2"	9"	24 1/2"
40/52" x 144"	20"	11 1/2"	45 1/2"	11"	27"	24"	9"	24 1/2"
44/56" x 156"	20"	12"	51 1/2"	13"	32 1/2"	24"	10 1/2"	24 1/2"
44/56" x 168"	20"	12"	57 1/2"	13"	30 1/2"	24"	10 1/2"	24 1/2"
44/56" x 180"	20"	12"	63 1/2"	11 1/2"	30"	27"	10 1/2"	24 1/2"
44/60" x 192"	20"	14"	69 1/2"	12 1/2"	30 1/2"	27"	11"	24 1/2"

ZI-A Base

Four Bases

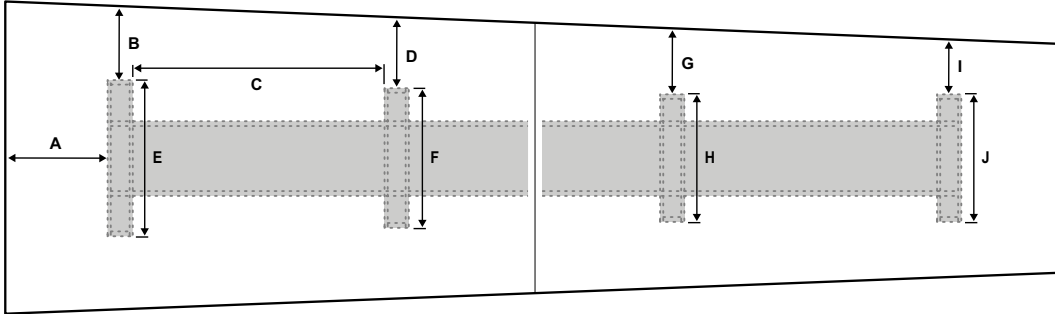

Top	A	B	C	D	E	F	G	H	I	J
44/56" x 180"	19 1/2"	14"	49"	13 1/2"	30 1/2"	27 1/2"	13"	24 1/2"	10 1/2"	22"
44/60" x 192"	19 1/2"	14"	53"	13 1/2"	30 1/2"	27"	13 1/2"	24"	10 1/2"	22"
44/60" x 204"	19 1/2"	14"	61"	13 1/2"	30 1/2"	27"	13"	24"	10 1/2"	22"

ZI-D Base

Two Bases

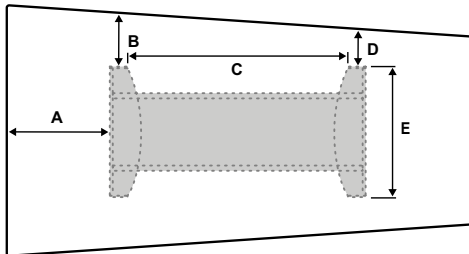

Top	A	B	C	D	E
36/48" x 90"	20"	10 1/2"	41"	7 1/2"	24 1/2"
36/48" x 96"	20"	10 1/2"	47"	7 1/2"	24 1/2"
36/48" x 108"	20"	10 1/2"	59"	7"	24"
40/52" x 120"	20"	11"	71"	9"	24 1/2"

ZI-D Base

Two Bases with Center Base

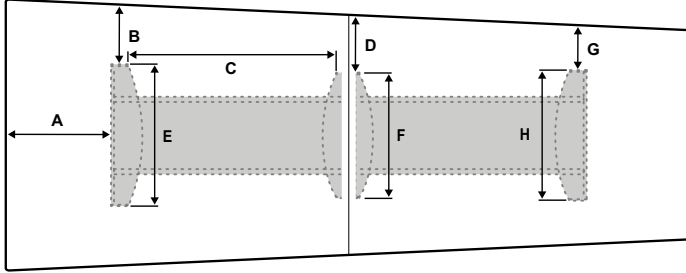

Top	A	B	C	D	E	F	G	H
40/52" x 132"	20"	11 1/2"	39 1/2"	11"	27 1/2"	24 1/2"	9"	24 1/2"
40/52" x 144"	20"	11 1/2"	45 1/2"	11"	27 1/2"	24 1/2"	9"	24 1/2"
44/56" x 156"	20"	12"	51 1/2"	11 1/2"	30 1/2"	27 1/2"	10 1/2"	24 1/2"
44/56" x 168"	20"	12"	57 1/2"	11 1/2"	30 1/2"	27 1/2"	10 1/2"	24 1/2"
44/56" x 180"	20"	12"	63 1/2"	11 1/2"	30 1/2"	27 1/2"	10 1/2"	24 1/2"
44/60" x 192"	20"	14"	69 1/2"	11"	27 1/2"	24 1/2"	9"	24 1/2"

Four Bases

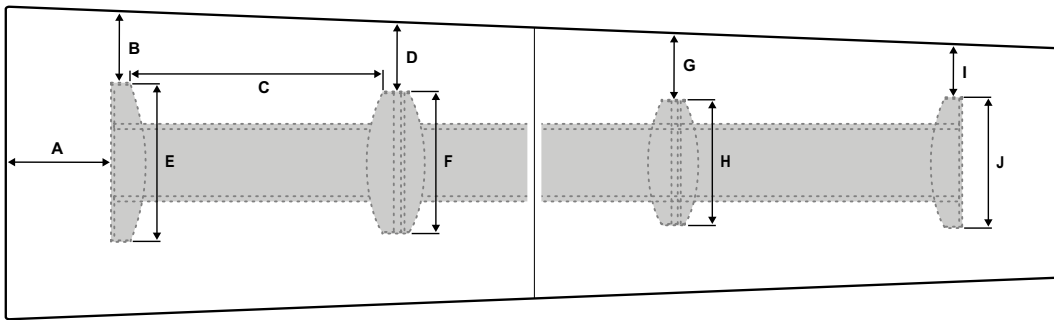

Top	A	B	C	D	E	F	G	H	I	J
44/60" x 204"	19 1/2"	14"	49"	13 1/2"	30 1/2"	27 1/2"	13"	24 1/2"	10 1/2"	24 1/2"
44/60" x 216"	19 1/2"	14"	53"	13 1/2"	30 1/2"	27 1/2"	13"	24 1/2"	10 1/2"	24 1/2"
44/60" x 240"	19 1/2"	14"	61"	13 1/2"	30 1/2"	27 1/2"	13"	24 1/2"	10 1/2"	24 1/2"

Track Kneespace

Based on the Shape and Edge Detail chosen, the following pages highlight the kneespace of each viable to Base configuration.

Coda-Vee Base

Single Base

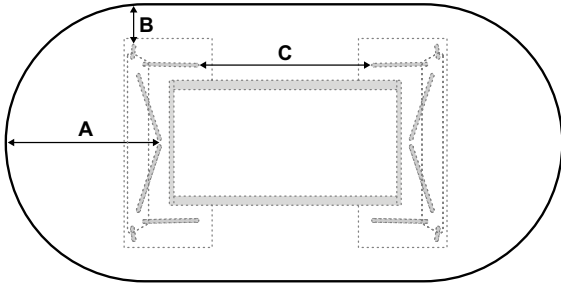

Top	A	B	C
36" x 72"	19"	5"	23 ½"
39" x 78"	19"	7"	29 ½"
42" x 84"	19"	8 ½"	35 ½"
48" x 90"	19"	11"	41 ½"
48" x 96"	19"	11"	47 ½"
52" x 108"	19"	12 ½"	59 ½"
52" x 120"	19"	12"	71 ½"

Two Bases with Center Base

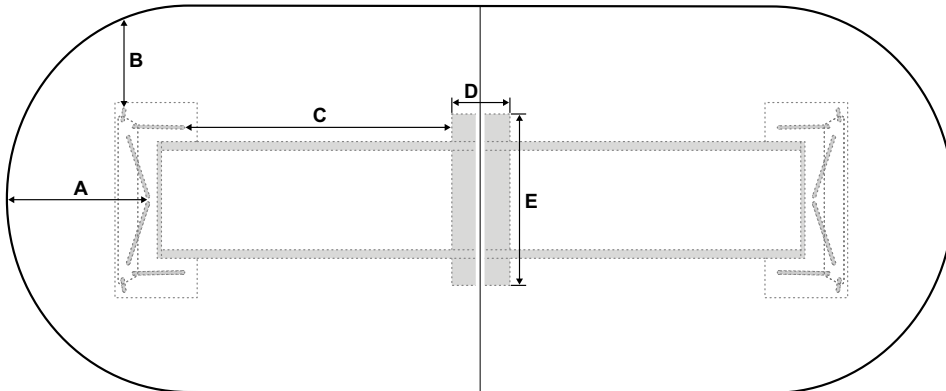

Top	A	B	C	D	E	F
54" x 132"	19"	12"	38"	8"	24"	15"
54" x 144"	19"	13 ½"	44"	8"	24"	15"
60" x 156"	19"	15 ½"	50"	8"	24"	19"
60" x 168"	19"	15 ½"	56"	8"	24"	19"
60" x 180"	19"	15 ½"	62"	8"	24"	19"
60" x 192"	19"	15 ½"	68"	8"	27"	16 ½"
60" x 204"	19"	15 ½"	74"	8"	27"	16 ½"
60" x 216"	19"	15 ½"	80"	8"	27"	16 ½"
60" x 240"	19"	15 ½"	92"	8"	27"	16 ½"

Coda-Wire Base

Two Bases

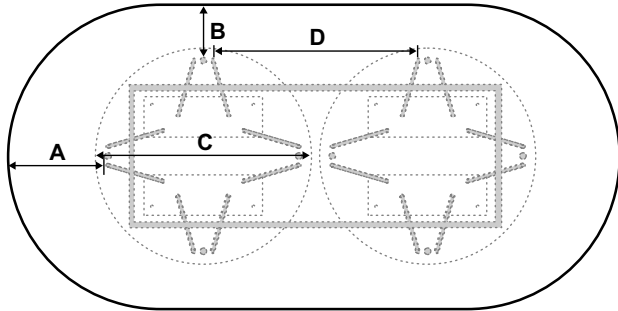

Top	A	B	C	D
36" x 72"	11"	6 1/2"	25 1/2"	24"
39" x 78"	11"	8"	25 1/2"	30"
42" x 84"	11"	9 1/2"	25 1/2"	36"
48" x 90"	17"	12 1/2"	25 1/2"	30"
48" x 96"	17"	12 1/2"	25 1/2"	36"
52" x 108"	17"	14 1/2"	25 1/2"	48"
54" x 120"	17"	15 1/2"	25 1/2"	60"
54" x 132"	17"	15 1/2"	25 1/2"	72"
54" x 144"	17"	15 1/2"	25 1/2"	84"

Two Bases with Center Base

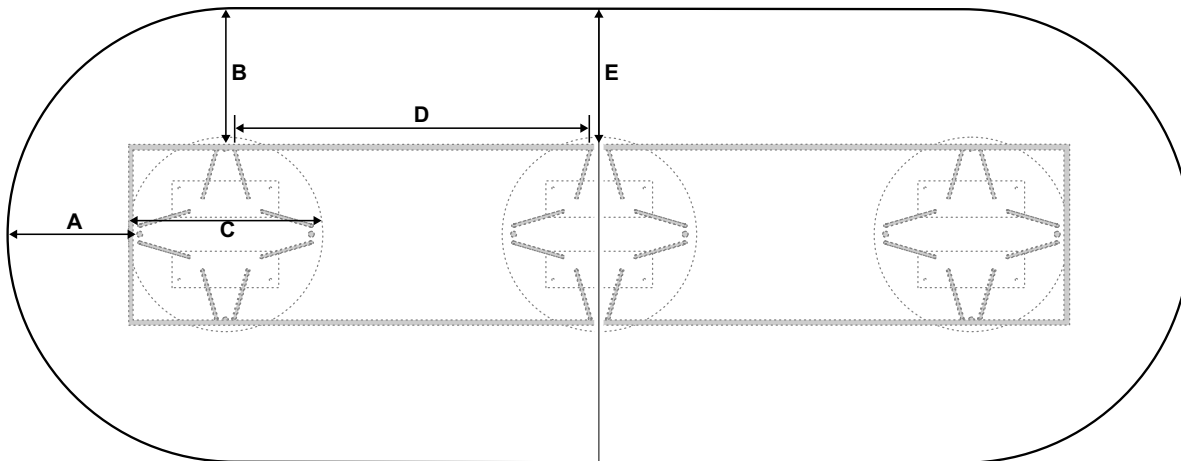

Top	A	B	C	D	E
60" x 156"	17"	18 1/2"	25 1/2"	46 1/2"	18 1/2"
60" x 168"	17"	18 1/2"	25 1/2"	52 1/2"	18 1/2"
60" x 180"	17"	18 1/2"	25 1/2"	58 1/2"	18 1/2"
60" x 192"	17"	18 1/2"	25 1/2"	64 1/2"	18 1/2"
60" x 204"	17"	18 1/2"	25 1/2"	70 1/2"	18 1/2"
60" x 216"	17"	18 1/2"	25 1/2"	76 1/2"	18 1/2"
60" x 240"	17"	18 1/2"	25 1/2"	88 1/2"	18 1/2"

Coda-X Base

Two Bases

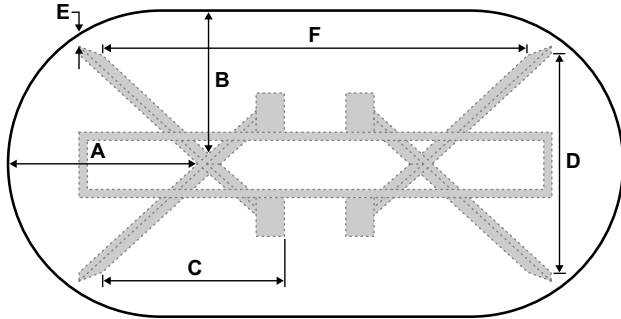

Top	A	B	C	D	E	F
39" x 78"	24"	18"	22 1/2"	27 1/2"	1 1/2"	53 1/2"
42" x 84"	27"	19 1/2"	22 1/2"	27 1/2"	4"	53 1/2"
48" x 90"	30"	22 1/2"	22 1/2"	27 1/2"	7 1/2"	53 1/2"
48" x 96"	30"	22 1/2"	22 1/2"	27 1/2"	7 1/2"	59 1/2"
52" x 108"	30"	24 1/2"	22 1/2"	27 1/2"	8 1/2"	71 1/2"
54" x 120"	30"	25 1/2"	22 1/2"	27 1/2"	9 1/2"	83 1/2"

Two Bases with Center Base

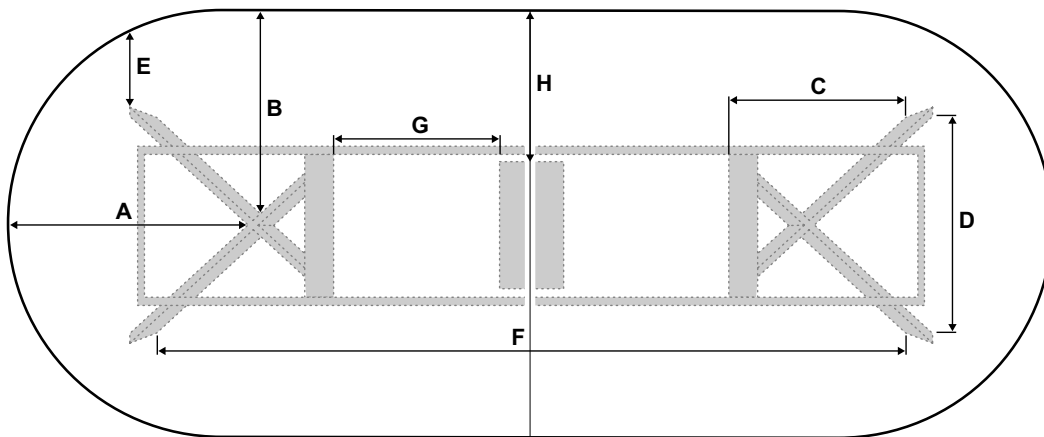

Top	A	B	C	D	E	F	G	H
54" x 132"	30"	25 1/2"	22 1/2"	27 1/2"	9 1/2"	95 1/2"	21"	15"
54" x 144"	30"	25 1/2"	22 1/2"	27 1/2"	9 1/2"	6"	107 1/2"	15"
60" x 156"	30"	28 1/2"	13 1/2"	27 1/2"	11"	7 1/2"	119 1/2"	17"
60" x 168"	30"	28 1/2"	22 1/2"	27 1/2"	11"	7 1/2"	131 1/2"	17"
60" x 180"	30"	28 1/2"	22 1/2"	27 1/2"	11"	6"	143 1/2"	17"
60" x 192"	30"	28 1/2"	22 1/2"	27 1/2"	11"	7 1/2"	159"	18"
60" x 204"	30"	28 1/2"	22 1/2"	27 1/2"	11"	7 1/2"	167 1/2"	18"
60" x 216"	30"	28 1/2"	22 1/2"	27 1/2"	11"	7 1/2"	179 1/2"	18"
60" x 240"	30"	28 1/2"	22 1/2"	27 1/2"	11"	7 1/2"	203 1/2"	18"

Cylinder Base

Two Bases

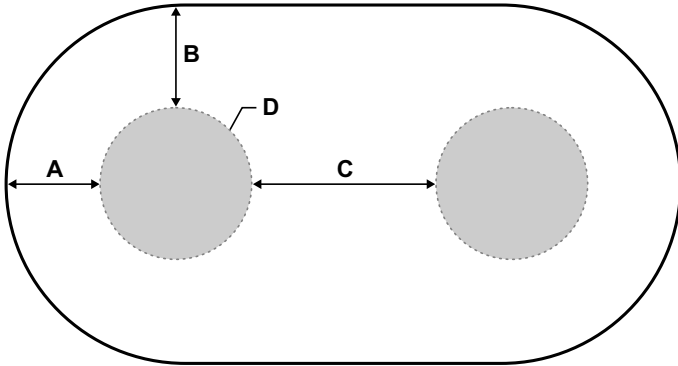

Top	A	B	C	D
48" x 90"	12 1/2"	14"	25"	20"
48" x 96"	14"	14"	28"	20"
52" x 108"	17"	16"	34"	20"
52" x 120"	20"	15"	36"	24"

Two Bases with Center Base

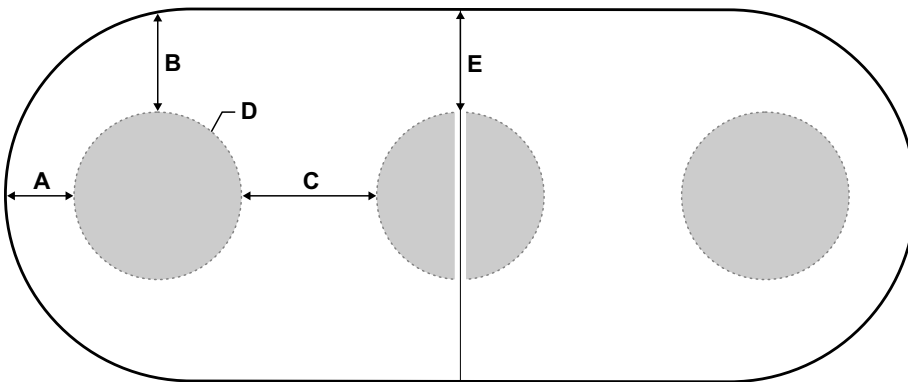

Top	A	B	C	D	E
54" x 132"	10"	14 1/2"	20"	24"	15"
54" x 144"	12"	15"	24"	24"	15"
60" x 156"	14"	18"	28"	24"	15"
60" x 168"	16"	18"	32"	24"	15"
60" x 180"	20"	18"	36"	24"	15"
60" x 192"	17"	15"	34"	30"	15"

Cylinder Base

Four Bases

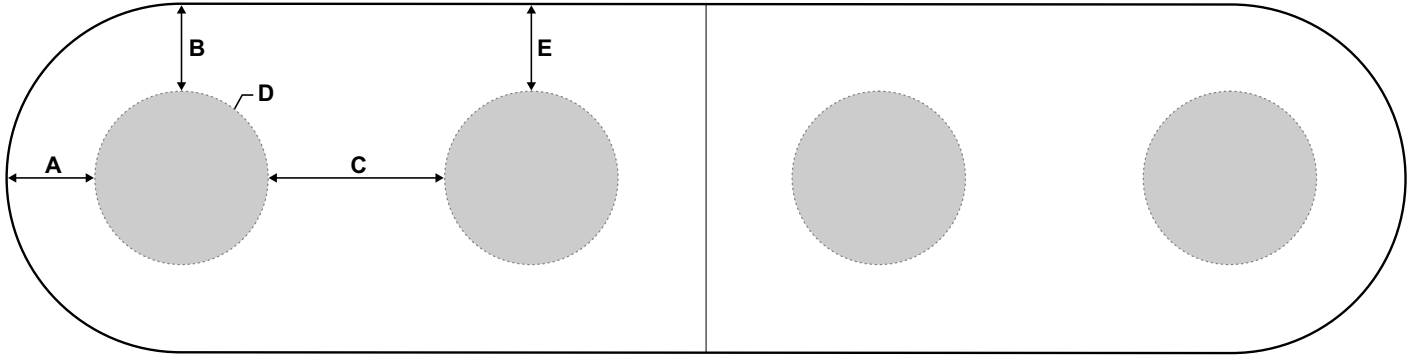

Top	A	B	C	D	E
60" x 204"	10 1/2"	15"	34"	30"	15"
60" x 216"	12"	15"	21"	30"	15"
60" x 240"	15"	15"	24"	30"	15"

Plinth Base

Two Bases

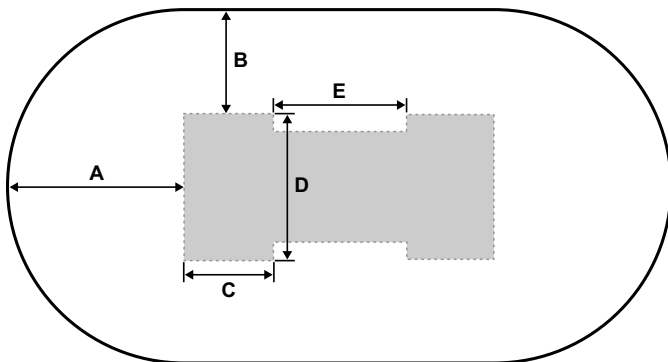

Top	A	B	C	D	E
48" x 90"	24"	14"	12"	20"	18"
48" x 96"	24"	14"	12"	20"	24"
52" x 108"	24"	16"	12"	20"	36"
54" x 120"	24"	15"	12"	24"	48"

Plinth Base

Two Bases with Center Base

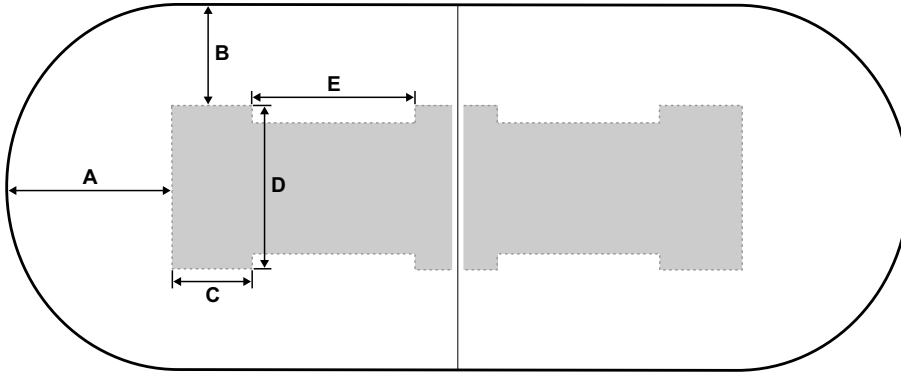

Top	A	B	C	D	E
54" x 132"	24"	15"	12"	24"	24"
54" x 144"	24"	15"	12"	24"	30"
60" x 156"	24"	18"	12"	24"	36"
60" x 168"	24"	18"	12"	24"	42"
60" x 180"	24"	18"	12"	22"	48"
60" x 192"	24"	16"	12"	28"	54"

Four Bases

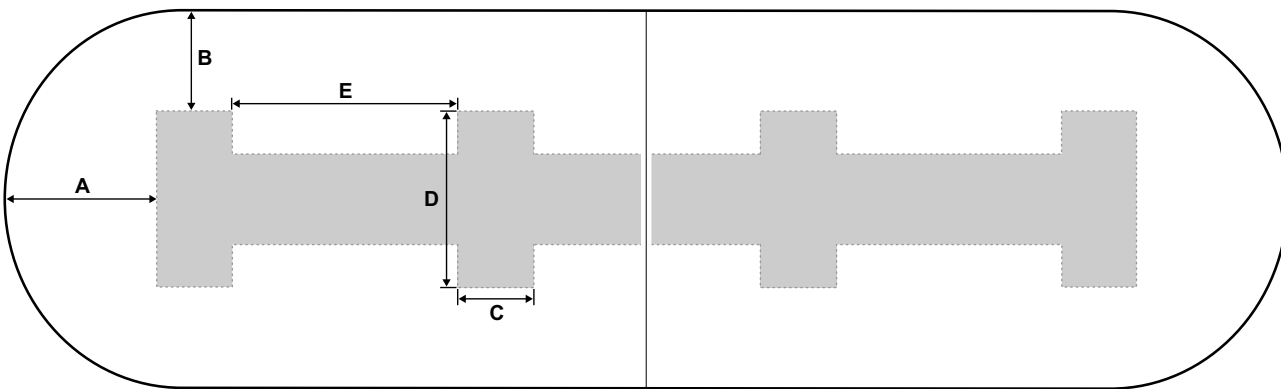

Top	A	B	C	D	E
60" x 204"	24"	16"	12"	28"	36"
60" x 216"	24"	16"	12"	28"	40"
60" x 240"	24"	16"	12"	28"	48"

Ryvit Base

Single Base

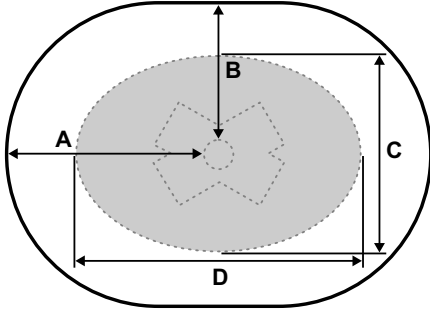

Top	A	B	C	D
30" x 42"	19 1/2"	13 1/2"	19"	28"
30" x 60"	28 1/2"	13 1/2"	22"	32"

Two Bases

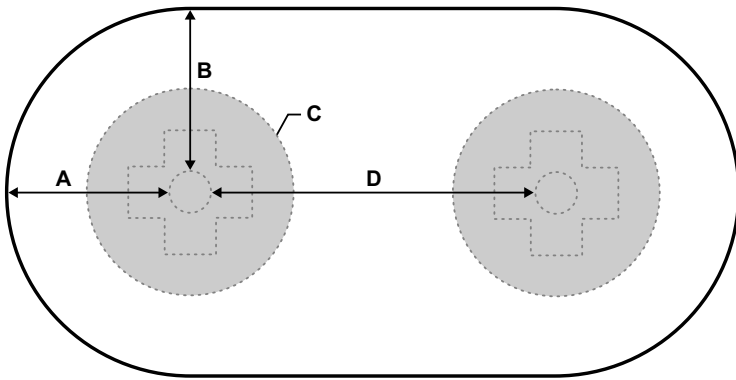

Top	A	B	C	D
36" x 78"	16"	16"	20"	32"
39" x 78"	17 1/2"	17 1/2"	20"	35"
42" x 84"	19"	19"	20"	38"
48" x 90"	20 1/2"	22"	26"	41"
48" x 96"	22"	22"	26"	44"
52" x 108"	25"	22"	26"	50"
54" x 120"	28"	24"	26"	55"

Ryvit Base

Two Bases with Center Base

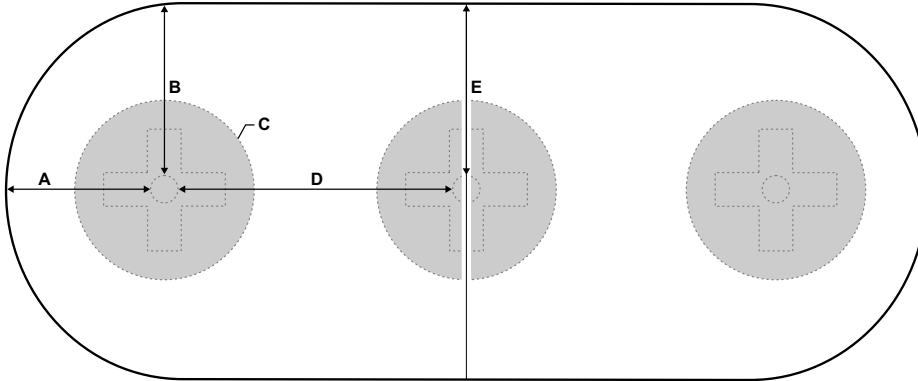

Top	A	B	C	D	E
54" x 132"	20"	24 ½"	26"	40"	25"
54" x 144"	22"	25"	26"	44"	25"
60" x 156"	24"	25 ½"	26"	48"	26"
60" x 168"	26"	28"	26"	52"	28"
60" x 180"	28"	28"	26"	56"	27 ½"
60" x 192"	30"	28"	30"	60"	28"

Four Bases

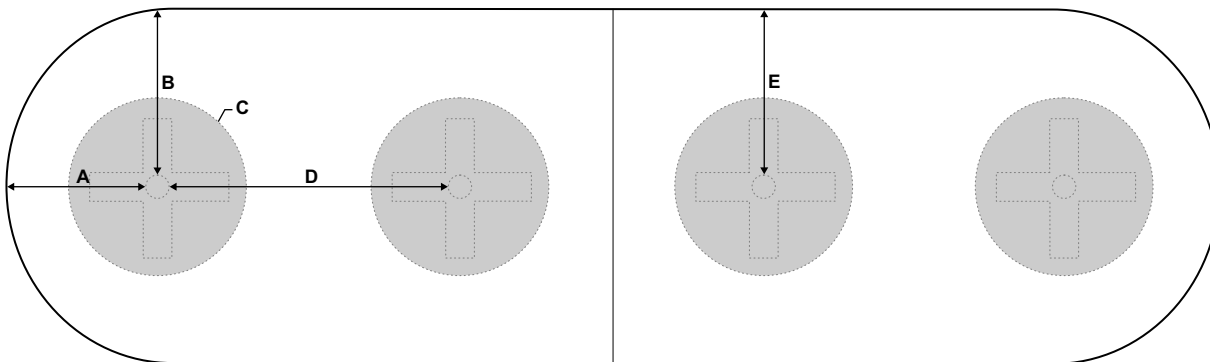

Top	A	B	C	D	E
60" x 204"	23 ½"	27 ½"	30"	47"	28"
60" x 216"	25"	28"	30"	50"	28"
60" x 240"	28"	28"	30"	56"	28"

Spyda-T Base

Two Bases

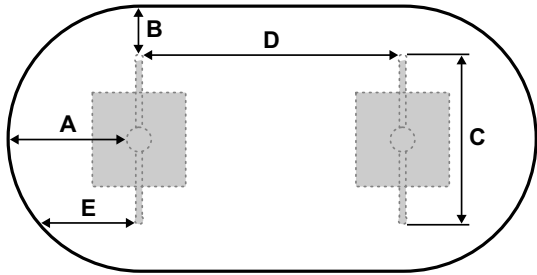

Top	A	B	C	D	E
36" x 72"	17 1/2"	6 1/2"	22"	35"	13 1/2"
39" x 78"	19"	8"	22"	38"	15 1/2"
42" x 84"	20 1/2"	9 1/2"	22"	41"	17 1/2"
48" x 90"	22"	10 1/2"	26"	44"	18"
48" x 96"	23 1/2"	10 1/2"	26"	47"	19 1/2"
52" x 108"	26 1/2"	12 1/2"	26"	53"	23"

Two Bases with Center Base

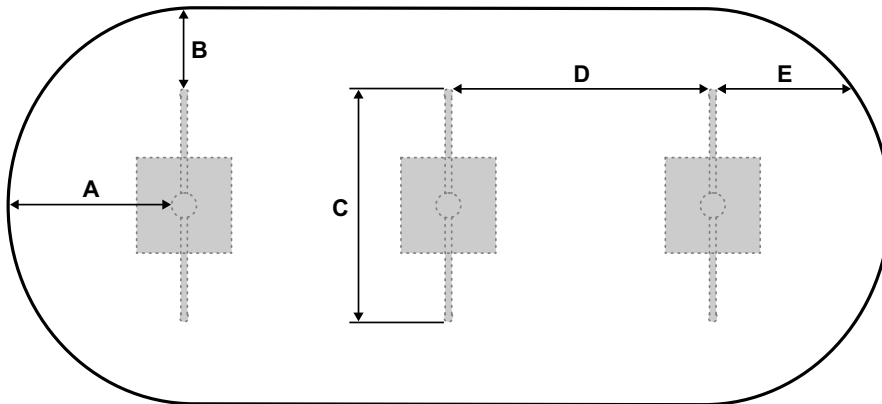

Top	A	B	C	D	E
54" x 120"	23 1/2"	11 1/2"	30"	35"	19"
54" x 132"	21 1/2"	11"	30"	43"	17"
54" x 144"	23 1/2"	11 1/2"	30"	47"	19"
60" x 156"	25 1/2"	11 1/2"	30"	51"	21 1/2"
60" x 168"	27 1/2"	14 1/2"	30"	55"	23 1/2"
60" x 180"	29 1/2"	14 1/2"	30"	59"	25 1/2"

Spyda-T Base

Four Bases

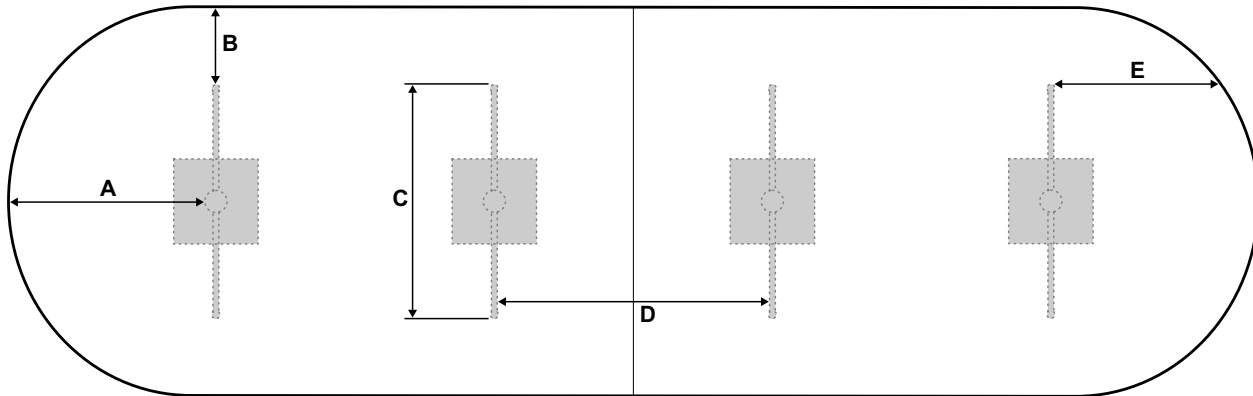

Top	A	B	C	D	E
60" x 192"	31 1/2"	12 1/2"	34"	41 1/2"	26"
60" x 204"	25"	12"	34"	50"	19 1/2"
60" x 216"	26 1/2"	12 1/2"	34"	53"	21"
60" x 240"	29 1/2"	12 1/2"	34"	59"	24"

Spyda-X Base

Single Base

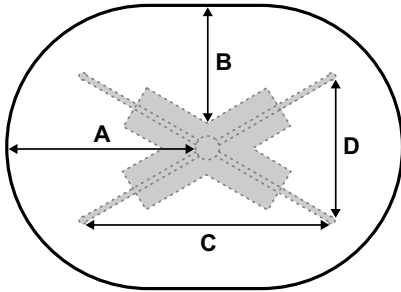

Top	A	B	C	D
30" x 42"	19"	13"	25 ½"	14 ½"
30" x 60"	26"	13"	29 ½"	16 ½"
36" x 72"	34"	16"	39 ½"	22 ½"
39" x 78"	37"	17 ½"	39 ½"	22 ½"
42" x 84"	40"	19"	39 ½"	22 ½"

Two Bases

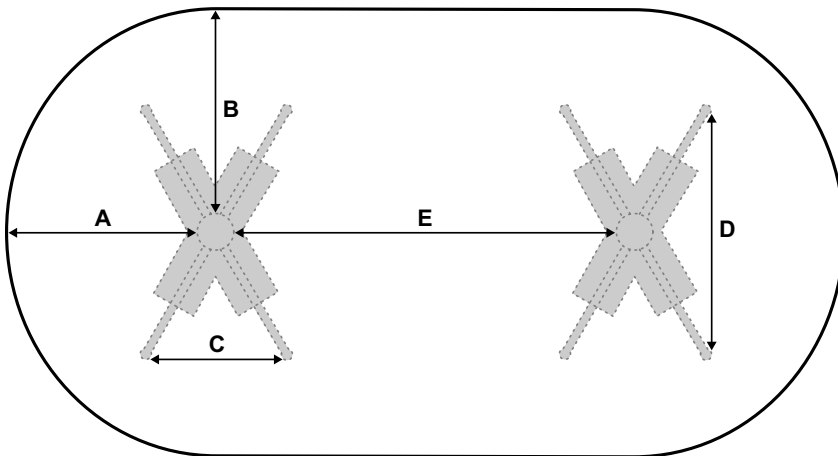

Top	A	B	C	D	E
48" x 90"	20 ½"	22"	14 ½"	25 ½"	41"
48" x 96"	22"	22"	14 ½"	25 ½"	44"
52" x 108"	25"	24"	15"	26"	50"
54" x 120"	28"	25"	16 ½"	29"	56"

Spyda-X Base

Two Bases with Center Base

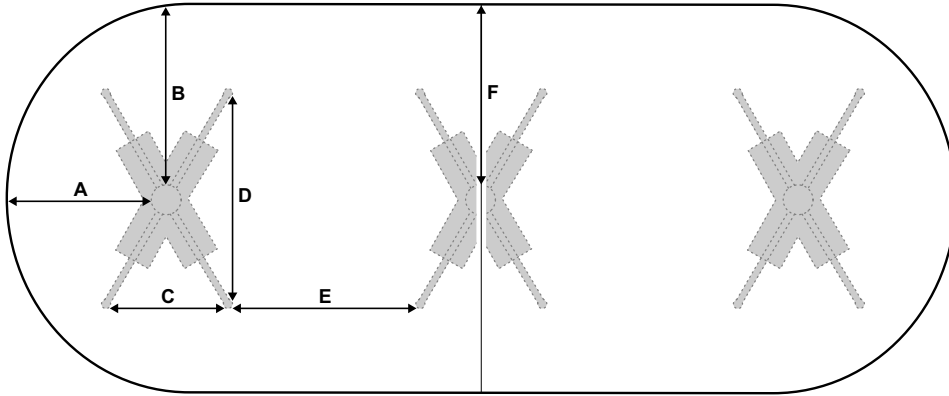

Top	A	B	C	D	E	F
54" x 132"	20"	24 ½"	16 ½"	29 ½"	26"	25"
54" x 144"	22"	25"	17"	29"	30"	25"
60" x 156"	24"	27 ½"	16 ½"	29"	34"	28"
60" x 168"	26"	28"	16 ½"	29 ½"	38"	28"
60" x 180"	28"	28"	17"	29 ½"	42"	28"
60" x 192"	30"	28"	17"	29 ½"	46"	28"

Four Bases

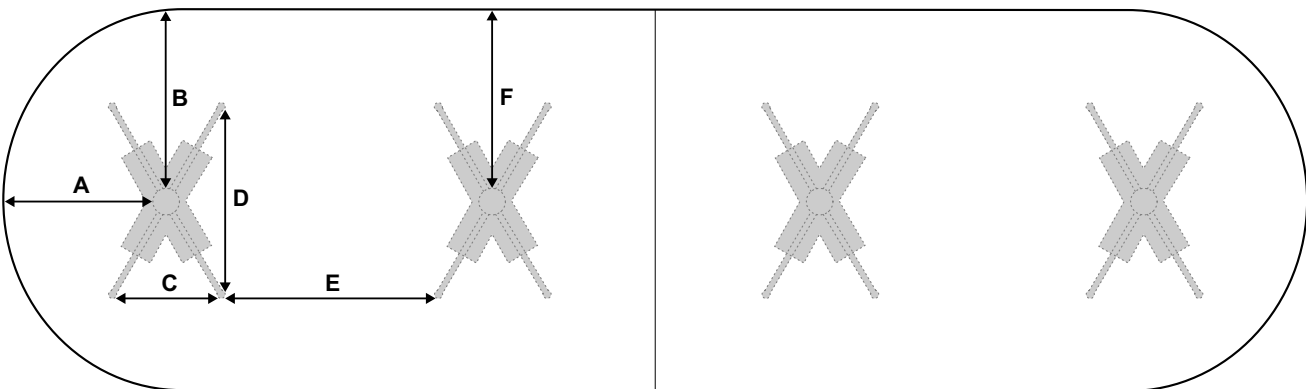

Top	A	B	C	D	E	F
60" x 204"	23 ½"	28"	16 ½"	29 ½"	33"	28"
60" x 216"	25"	28"	16 ½"	29 ½"	36"	28"
60" x 240"	28"	28"	16 ½"	29 ½"	42"	28"

Spyda-Y Base

Two Bases

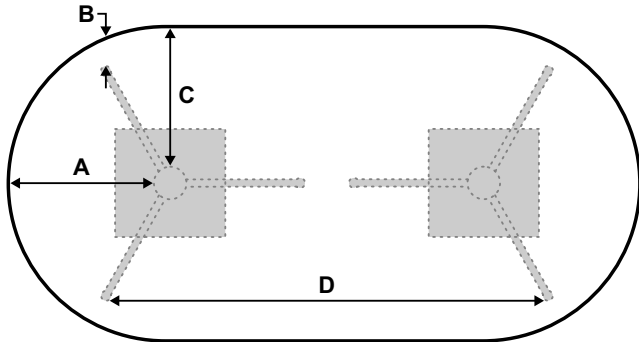

Top	A	B	C	D
36" x 72"	17 1/2"	3"	17 1/2"	5 1/2"
39" x 78"	19"	4 1/2"	19"	54"
48" x 90"	20 1/2"	6"	20 1/2"	56 1/2"
48" x 96"	22"	9"	23 1/2"	59 1/2"
52" x 108"	23 1/2"	9 1/2"	23 1/2"	62 1/2"
54" x 120"	29 1/2"	11 1/2"	26 1/2"	76 1/2"

Two Bases with Center Base

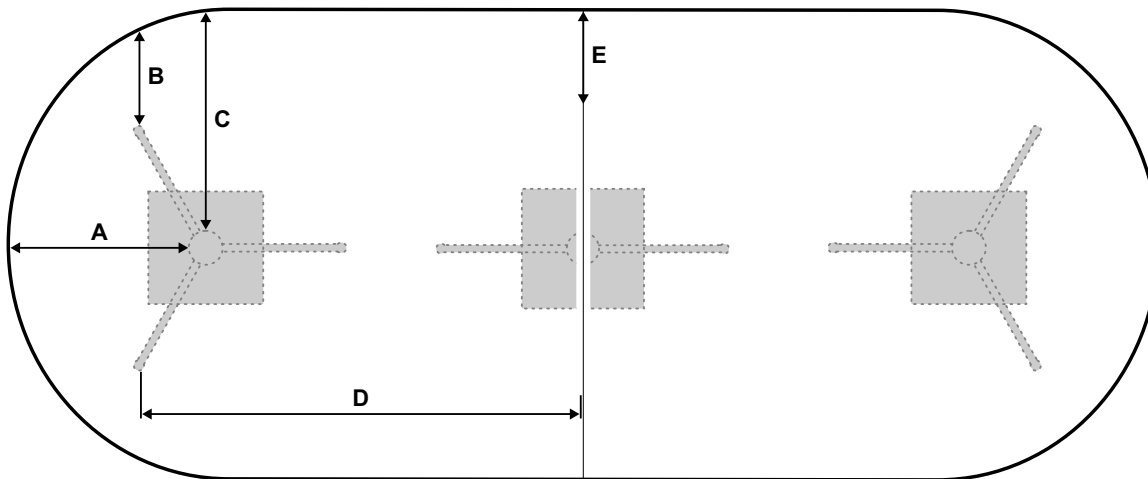

Top	A	B	C	D	E
54" x 132"	21 1/2"	8"	26"	52"	11 1/2"
54" x 144"	23 1/2"	9"	26 1/2"	56"	11 1/2"
60" x 156"	26 1/2"	12"	29"	60"	14 1/2"
60" x 168"	27 1/2"	13"	29 1/2"	64"	14 1/2"
60" x 180"	29 1/2"	23 1/2"	29 1/2"	67 1/2"	14 1/2"

Spyda-Y Base

Four Bases

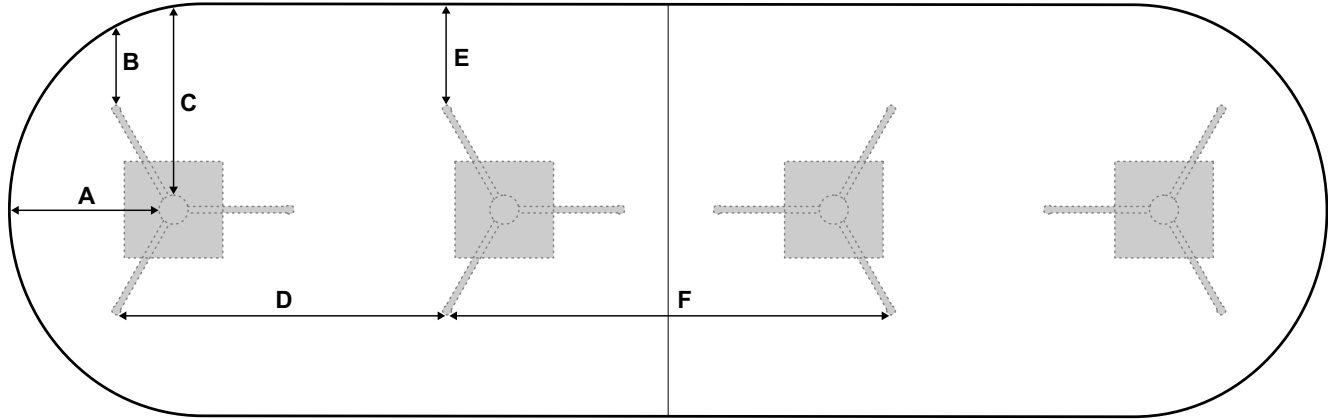

Top	A	B	C	D	E	F
60" x 192"	23 1/2"	11"	29"	47 1/2"	14 1/2"	64 1/2"
60" x 204"	25"	12"	29"	50 1/2"	14 1/2"	67 1/2"
60" x 216"	26 1/2"	12 1/2"	29 1/2"	53 1/2"	15"	70 1/2"
60" x 240"	29 1/2"	13 1/2"	29 1/2"	59 1/2"	14 1/2"	76 1/2"

Uffizi-Loop Base

Two Bases

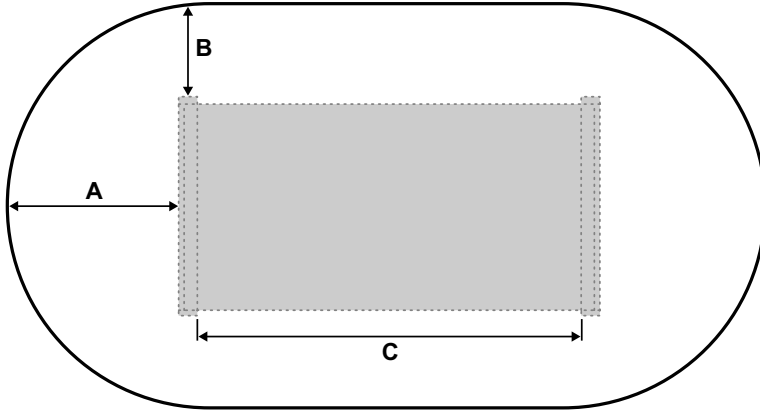

Top	A	B	C
48" x 90"	20"	10 ½"	45"
48" x 96"	20"	11"	51"
52" x 108"	20"	12 ½"	63"
54" x 120"	20"	13 ½"	75"

Two Bases with Center Base

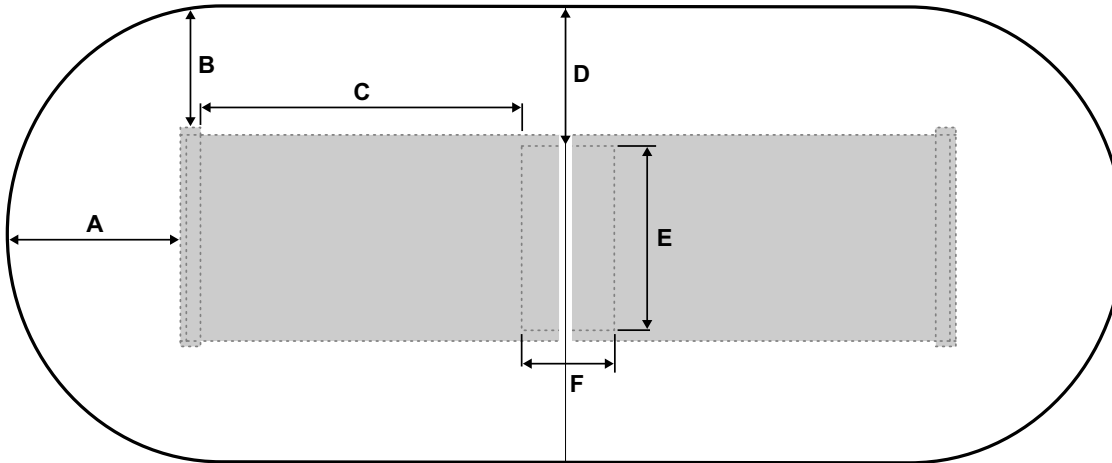

Top	A	B	C	D	E	F
54" x 132"	20"	13 ½"	38"	16"	22"	11"
54" x 144"	20"	13 ½"	44"	16"	22"	11"
60" x 156"	20"	15 ½"	50"	19"	22"	11"
60" x 168"	20"	15 ½"	56"	19"	22"	11"
60" x 180"	20"	15 ½"	62"	19"	22"	11"
60" x 192"	20"	15 ½"	68"	19"	22"	11"
60" x 204"	20"	15 ½"	74"	19"	22"	11"
60" x 216"	20"	15 ½"	80"	19"	22"	11"
60" x 240"	20"	15 ½"	92"	19"	22"	11"

Zi-A Base

Two Bases

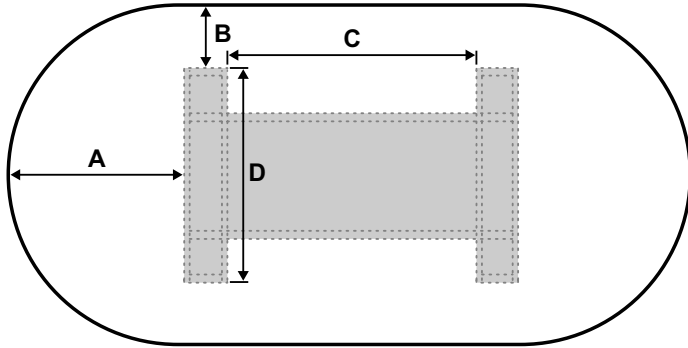

Top	A	B	C	D
39" x 78"	20"	7 1/2"	29"	24 1/2"
42" x 84"	24"	9"	27"	24 1/2"
48" x 90"	24"	12"	33"	24 1/2"
48" x 96"	24"	9"	39"	24 1/2"
52" x 108"	24"	14"	51"	24 1/2"
54" x 120"	24"	13 1/2"	63"	27 1/2"

Two Bases with Center Base

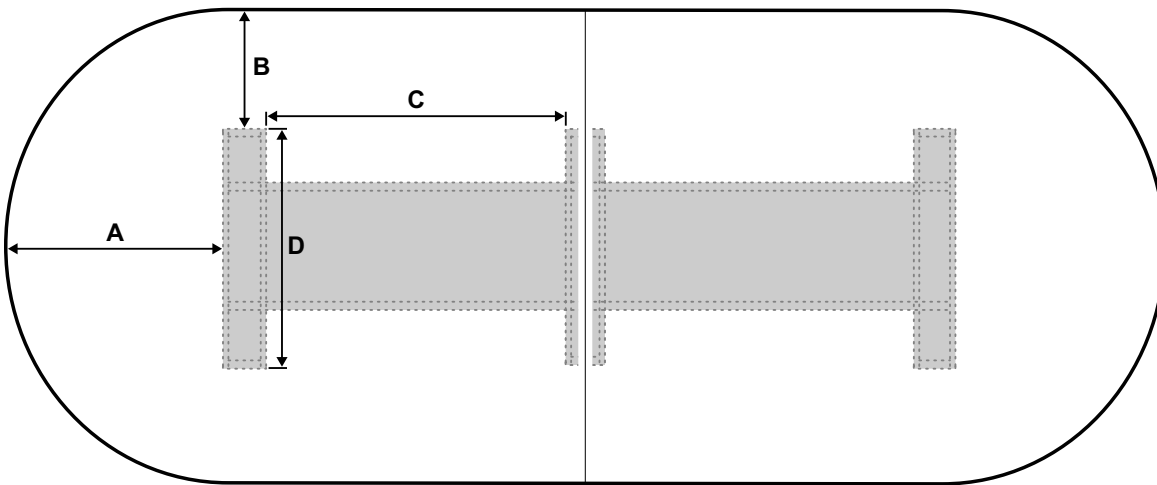

Top	A	B	C	D
54" x 132"	24"	13 1/2"	35 1/2"	27 1/2"
54" x 144"	24"	13 1/2"	41 1/2"	27 1/2"
60" x 156"	24"	14 1/2"	47 1/2"	30 1/2"
60" x 168"	24"	14 1/2"	53 1/2"	30 1/2"
60" x 180"	24"	14 1/2"	59 1/2"	30 1/2"
60" x 192"	24"	14 1/2"	65 1/2"	30 1/2"

Zi-A Base

Four Bases

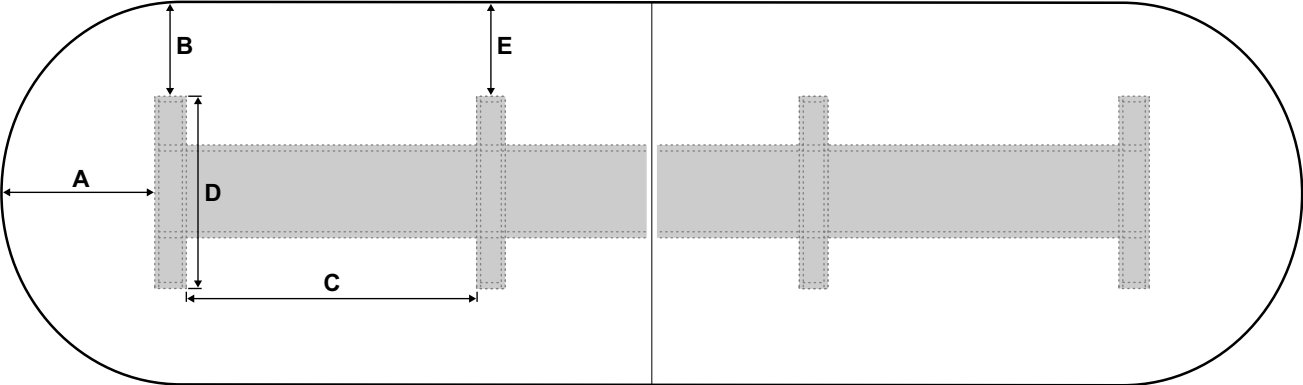

Top	A	B	C	D	E
60" x 204"	24"	14 1/2"	46"	30 1/2"	15"
60" x 216"	24"	14 1/2"	50"	30 1/2"	15"
60" x 240"	24"	14 1/2"	58"	30 1/2"	15"

Zi-D Base

Two Bases

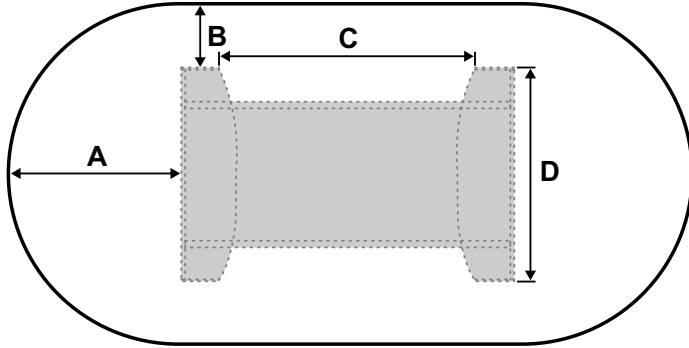

Top	A	B	C	D
39" x 78"	20"	7 ½"	29"	24 ½"
42" x 84"	20"	9"	35"	24 ½"
48" x 90"	24"	12"	33"	24 ½"
48" x 96"	24"	12"	39"	24 ½"
52" x 108"	24"	14"	51"	24 ½"
54" x 120"	24"	13 ½"	63"	27 ½"

Two Bases with Center Base

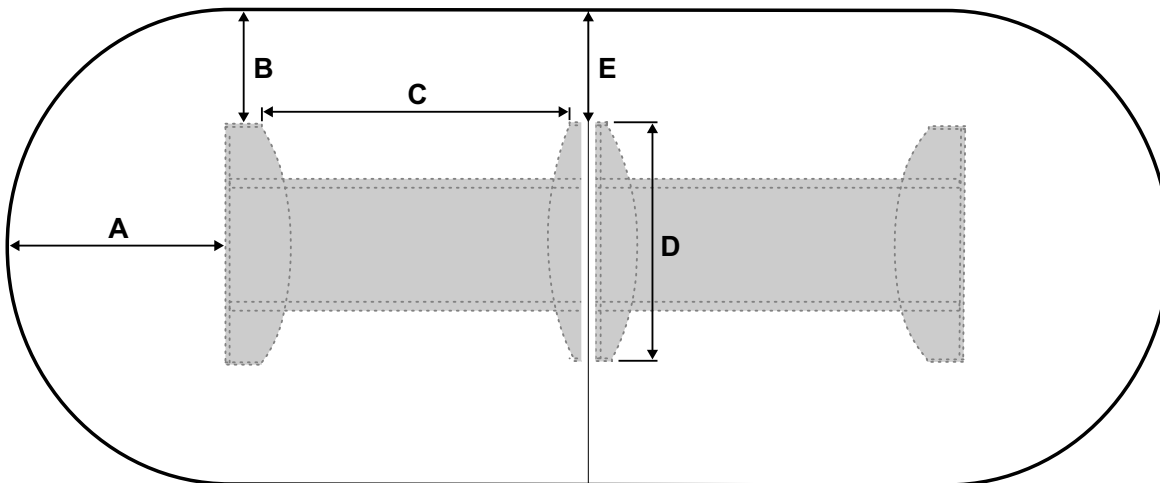

Top	A	B	C	D	E
54" x 132"	24"	13 ½"	35 ½"	27 ½"	13 ½"
54" x 144"	24"	13 ½"	41 ½"	27 ½"	13 ½"
60" x 156"	24"	14 ½"	47 ½"	30 ½"	15"
60" x 168"	24"	14 ½"	53 ½"	30 ½"	15"
60" x 180"	24"	14 ½"	59 ½"	30 ½"	15"
60" x 192"	24"	14 ½"	65 ½"	30 ½"	15"

Zi-A Base

Four Bases

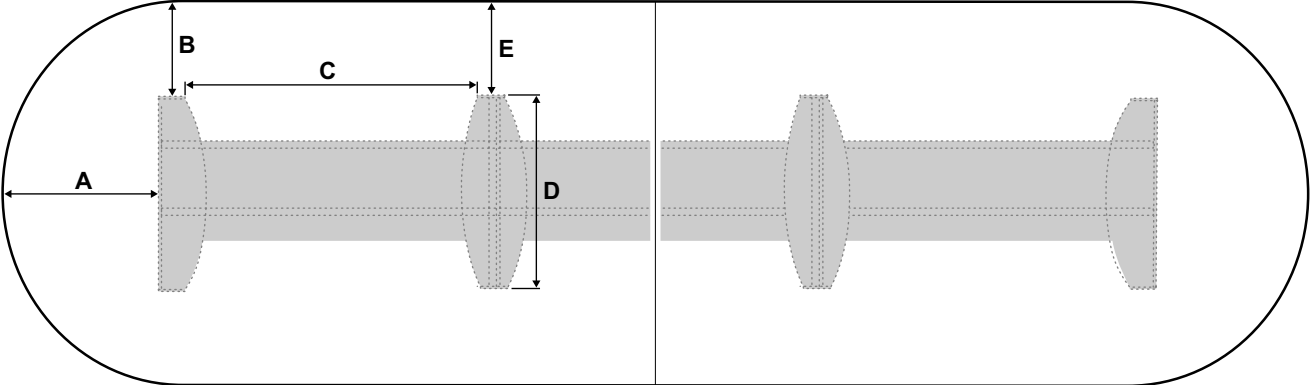

Top	A	B	C	D	E
60" x 204"	24"	14 1/2"	46"	30 1/2"	15"
60" x 216"	24"	14 1/2"	50"	30 1/2"	15"
60" x 240"	24"	14 1/2"	58"	30 1/2"	15"

Boat Kneespace

Based on the Shape and Edge Detail chosen, the following pages highlight the kneespace of each viable to Base configuration.

Coda-Vee Base

Single Base

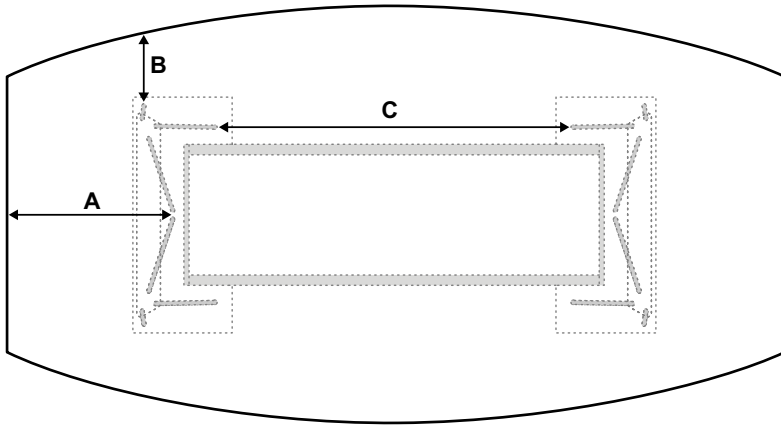

Top	A	B	C
32/48" x 90"	19"	8"	41 ½"
32/48" x 96"	19"	8"	47 ½"
34/52" x 108"	19"	9"	59 ½"
36/54" x 120"	19"	9 ½"	71 ½"

Two Bases with Center Base

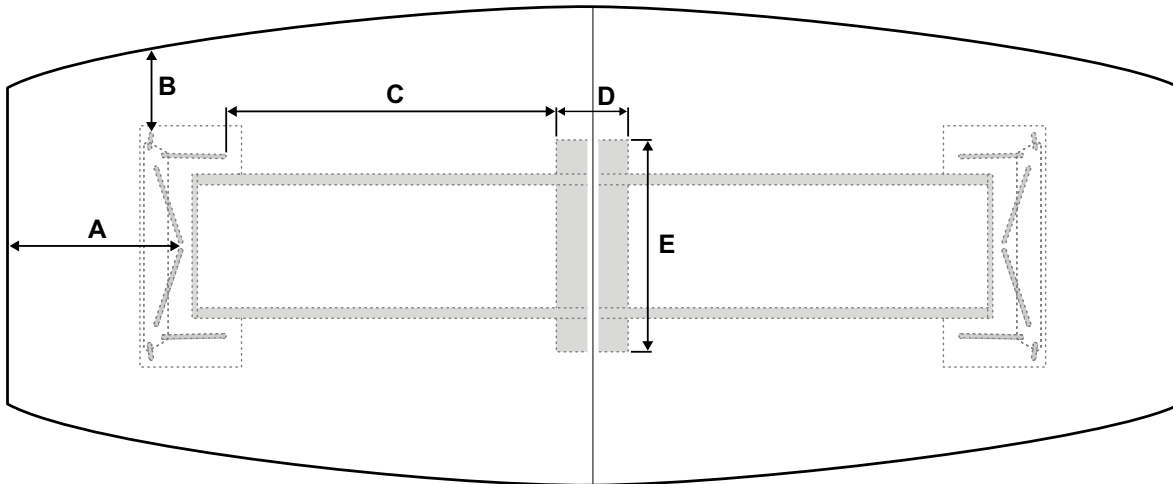

Top	A	B	C	D	E	F
36/54" x 132"	19"	9"	38"	8"	24"	15"
36/54" x 144"	19"	9"	44"	8"	24"	15"
40/60" x 156"	19"	11"	50"	8"	24"	18"
40/60" x 168"	19"	11"	56"	8"	24"	18"
40/60" x 180"	19"	10 ½"	62"	8"	24"	18"
40/60" x 192"	19"	10 ½"	68"	8"	27"	16 ½"
40/60" x 204"	19"	10 ½"	74"	8"	27"	16 ½"
40/60" x 216"	19"	10"	80"	8"	27"	16 ½"
40/60" x 240"	19"	10"	92"	8"	27"	16 ½"

Coda-Wire Base

Two Bases

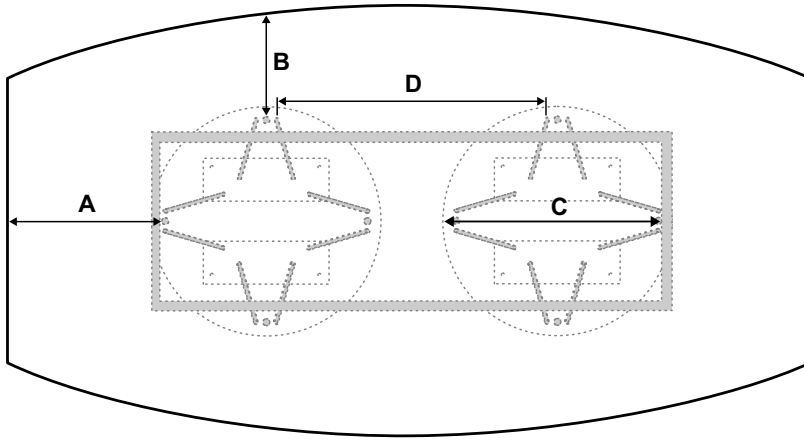

Top	A	B	C	D
32/48" x 90"	17"	11 1/2"	25 1/2"	30"
32/48" x 96"	17"	11 1/2"	25 1/2"	36"
34/52" x 108"	17"	12 1/2"	25 1/2"	48"
36/54" x 120"	17"	13"	25 1/2"	60"
36/54" x 132"	17"	12 1/2"	25 1/2"	72"
36/54" x 144"	17"	12"	25 1/2"	84"

Two Bases with Center Base

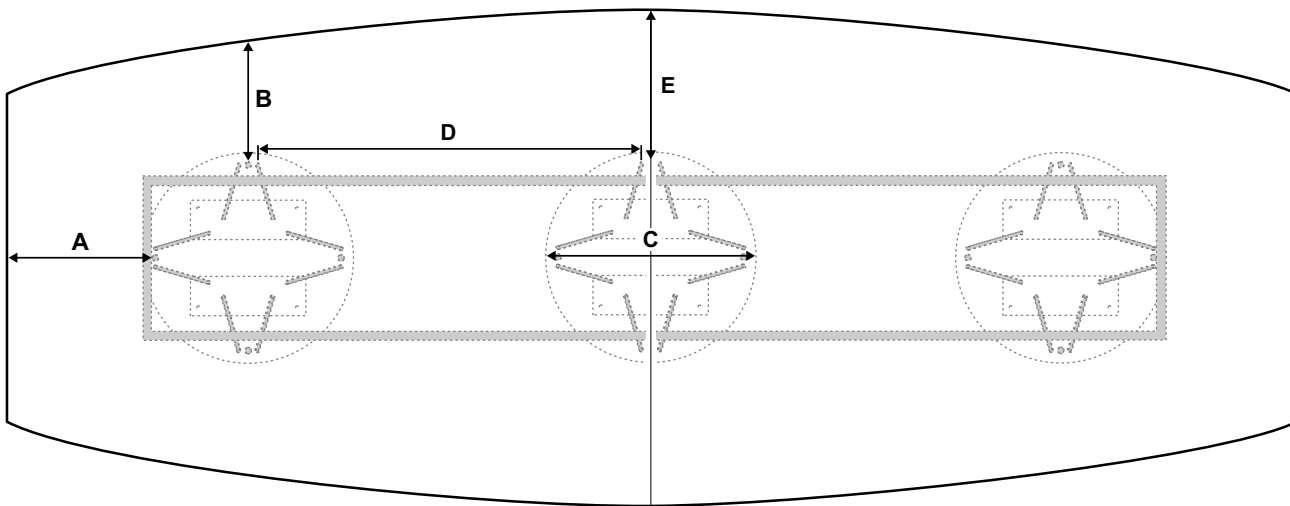

Top	A	B	C	D	E
40/60" x 156"	17"	14 1/2"	25 1/2"	46 1/2"	18 1/2"
40/60" x 168"	17"	14"	25 1/2"	52 1/2"	18 1/2"
40/60" x 180"	17"	14"	25 1/2"	58 1/2"	18 1/2"
40/60" x 192"	17"	13 1/2"	25 1/2"	64 1/2"	18 1/2"
40/60" x 204"	17"	13"	25 1/2"	70 1/2"	18 1/2"
40/60" x 216"	17"	13"	25 1/2"	76 1/2"	18 1/2"
40/60" x 240"	17"	12 1/2"	25 1/2"	88 1/2"	18 1/2"

Coda-X Base

Two Bases

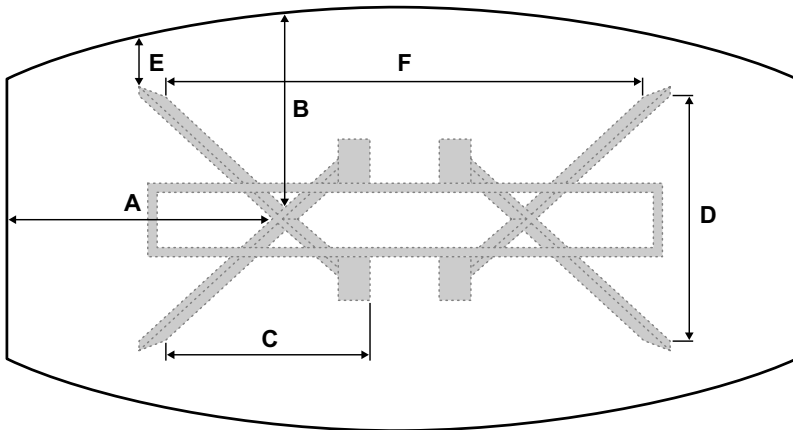

Top	A	B	C	D	E	F
32/48" x 90"	30"	22"	22 1/2"	27 1/2"	5 1/2"	53 1/2"
32/48" x 96"	30"	21 1/2"	22 1/2"	27 1/2"	5 1/2"	59 1/2"
34/52" x 108"	30"	23"	22 1/2"	27 1/2"	6 1/2"	71 1/2"
36/54" x 120"	30"	23 1/2"	23 1/2"	27 1/2"	7"	83 1/2"

Two Bases with Center Base

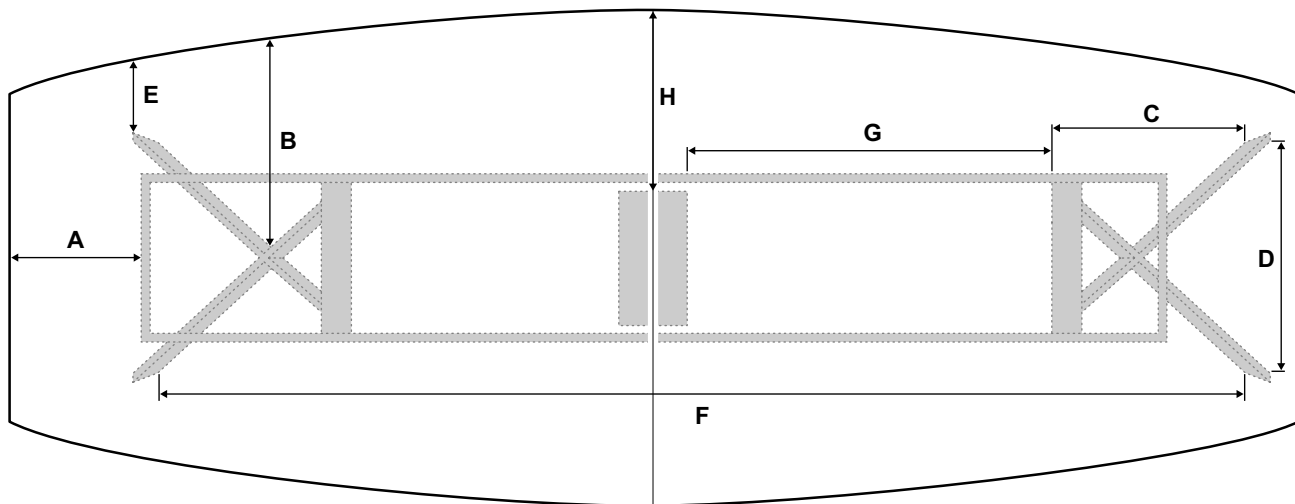

Top	A	B	C	D	E	F	G	H
36/54" x 132"	30"	23"	22 1/2"	27 1/2"	7"	95 1/2"	21"	19"
36/54" x 144"	30"	22 1/2"	22 1/2"	27 1/2"	6 1/2"	107 1/2"	27"	19"
40/60" x 156"	30"	25"	13 1/2"	27 1/2"	8 1/2"	7 1/2"	33"	22"
40/60" x 168"	30"	24 1/2"	22 1/2"	27 1/2"	8 1/2"	7 1/2"	39"	22"
40/60" x 180"	30"	24 1/2"	22 1/2"	27 1/2"	8"	6"	45"	22"
40/60" x 192"	30"	24"	22 1/2"	27 1/2"	8"	7 1/2"	51"	22"
40/60" x 204"	30"	24"	22 1/2"	27 1/2"	7 1/2"	7 1/2"	57"	22"
44/60" x 216"	30"	23 1/2"	22 1/2"	27 1/2"	7 1/2"	7 1/2"	63 1/2"	22"

Cylinder Base

Two Bases

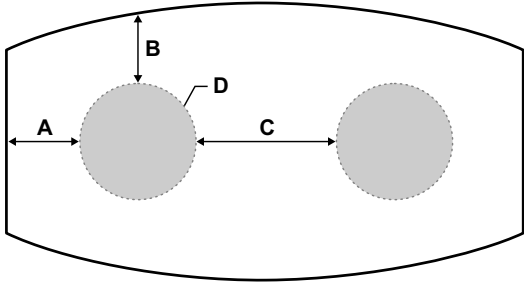

Top	A	B	C	D
32/48" x 90"	12 1/2"	12"	25"	20"
32/48" x 96"	14"	12"	28"	20"
34/52" x 108"	17"	14"	34"	20"
36/54" x 120"	18"	13"	36"	24"

Two Bases with Center Base

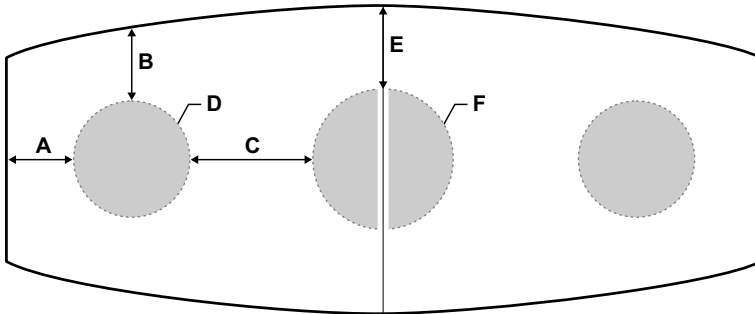

Top	A	B	C	D	E	F
36/54" x 132"	12"	13"	22"	20"	15"	24"
36/54" x 144"	14"	13"	26"	20"	15"	24"
40/60" x 156"	16"	15 1/2"	30"	20"	18"	24"
40/60" x 168"	18"	15 1/2"	34"	20"	18"	24"
40/60" x 180"	20"	15 1/2"	38"	20"	18"	24"
40/60" x 192"	22"	15 1/2"	42"	20"	18"	24"

Cylinder Base

Four Bases

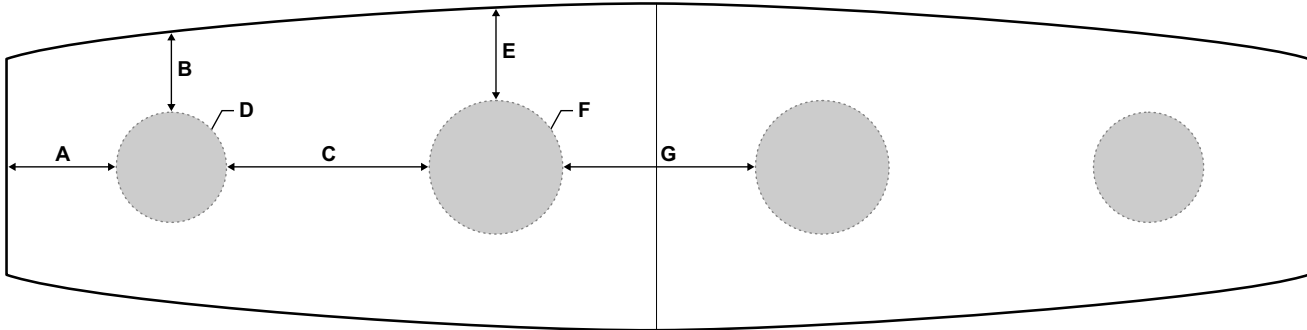

Top	A	B	C	D	E	F	G
40/60" x 204"	15 1/2"	14 1/2"	29"	20"	17 1/2"	24"	27"
40/60" x 216"	17"	14 1/2"	32"	20"	17 1/2"	24"	30"
40/60" x 240"	20"	14 1/2"	38"	20"	17 1/2"	24"	36"

Plinth Base

Two Bases

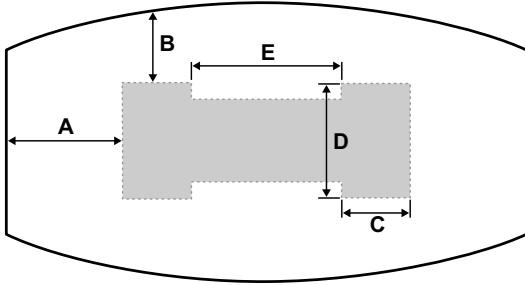

Top	A	B	C	D	E
32/48" x 90"	20"	12 ½"	12"	20"	26"
32/48" x 96"	20"	12 ½"	12"	20"	32"
34/52" x 108"	20"	13 ½"	12"	20"	44"
36/54" x 120"	20"	14"	12"	20"	56"

Two Bases with Center Base

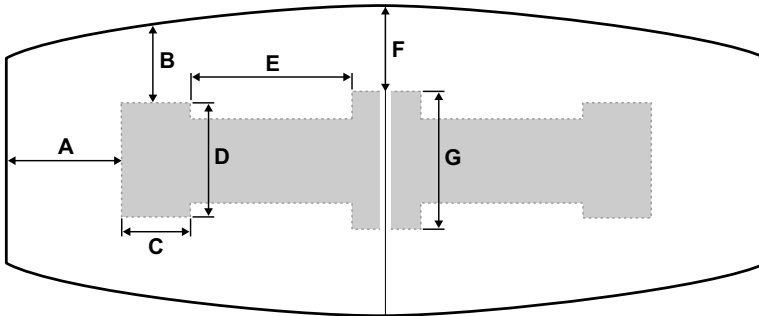

Top	A	B	C	D	E	F	G
36/54" x 132"	20"	13 ½"	12"	20"	28"	15"	24"
36/54" x 144"	20"	13 ½"	12"	20"	34"	15"	24"
40/60" x 156"	20"	15 ½"	12"	20"	40"	16"	24"
40/60" x 168"	20"	15 ½"	12"	20"	46"	16"	24"
40/60" x 180"	20"	15"	12"	20"	52"	16"	24"
40/60" x 192"	20"	14 ½"	12"	20"	58"	16"	24"

Plinth Base

Four Bases

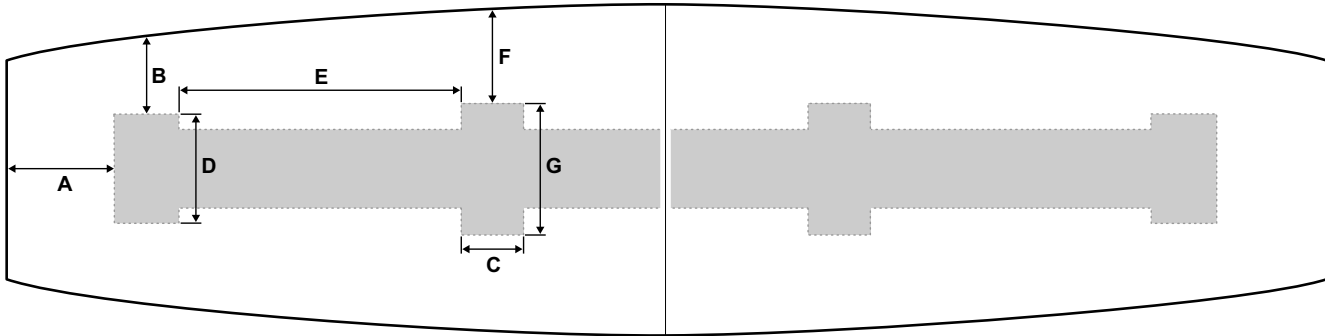

Top	A	B	C	D	E	F	G
40/60" x 204"	19 1/2"	14 1/2"	12"	20"	39"	17 1/2"	24"
40/60" x 216"	19 1/2"	14"	12"	20"	43"	15"	24"
40/60" x 240"	19 1/2"	14"	12"	20"	51"	18"	24"

Ryvit Base

Single Base

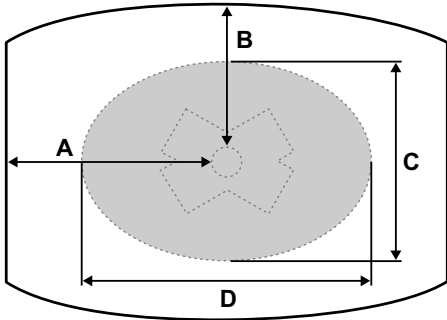

Top	A	B	C	D
24/30" x 42"	19 1/2"	13 1/2"	19"	28"
24/30" x 60"	28 1/2"	13 1/2"	22"	32"

Two Bases

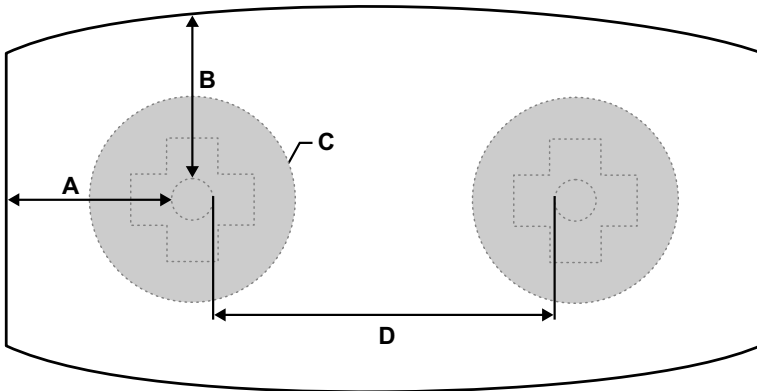

Top	A	B	C	D
28/36" x 72"	16"	15"	20"	32"
30/39" x 78"	17 1/2"	16 1/2"	20"	35"
30/42" x 84"	19"	17 1/2"	20"	38"
32/48" x 90"	20 1/2"	20"	26"	41"
32/48" x 96"	22"	20"	26"	44"
34/52" x 108"	25"	22"	26"	50"
36/54" x 120"	28"	23"	26"	55"

Ryvit Base

Two Bases with Center Base

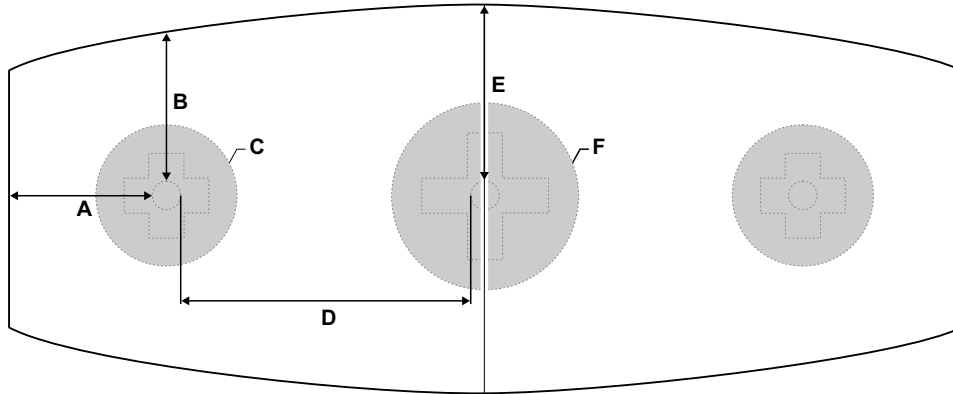

Top	A	B	C	D	E	F
36/54" x 132"	20"	21"	20"	40"	25"	26"
36/54" x 144"	22"	21"	20"	44"	25"	26"
40/60" x 156"	24"	23 1/2"	20"	48"	28"	26"
40/60" x 168"	26"	23 1/2"	20"	52"	28"	26"
40/60" x 180"	28"	23 1/2"	20"	56"	28"	26"
40/60" x 192"	30"	26"	26"	60"	28"	30"

Four Bases

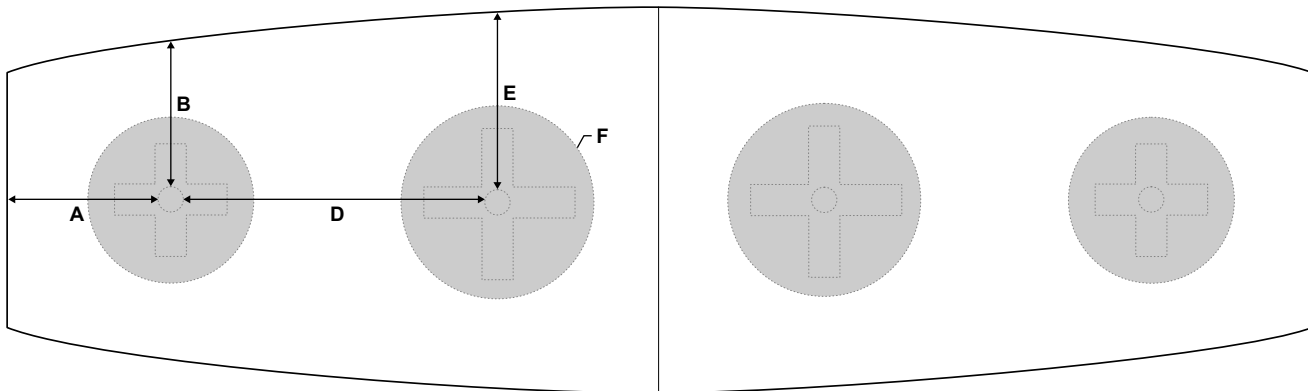

Top	A	B	C	D	E	F
40/60" x 204"	23 1/2"	22 1/2"	26"	47"	27 1/2"	30"
40/60" x 216"	25"	22 1/2"	26"	50"	27 1/2"	30"
40/60" x 240"	28"	22 1/2"	26"	56"	27 1/2"	30"

Spyda-T Base

Two Bases

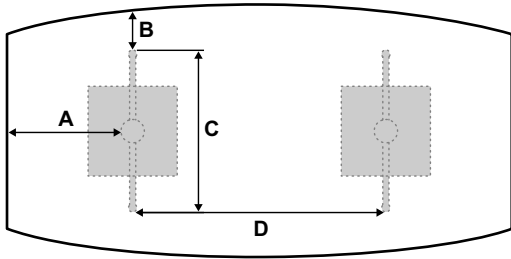

Top	A	B	C	D
28/36" x 72"	17 1/2"	5 1/2"	22"	35"
30/39" x 78"	19"	7"	22"	38"
30/42" x 84"	20 1/2"	8"	22"	41"
32/48" x 90"	22"	8 1/2"	26"	44"
32/48" x 96"	23 1/2"	8 1/2"	26"	47"
34/52" x 108"	26 1/2"	10 1/2"	26"	53"

Two Bases with Center Base

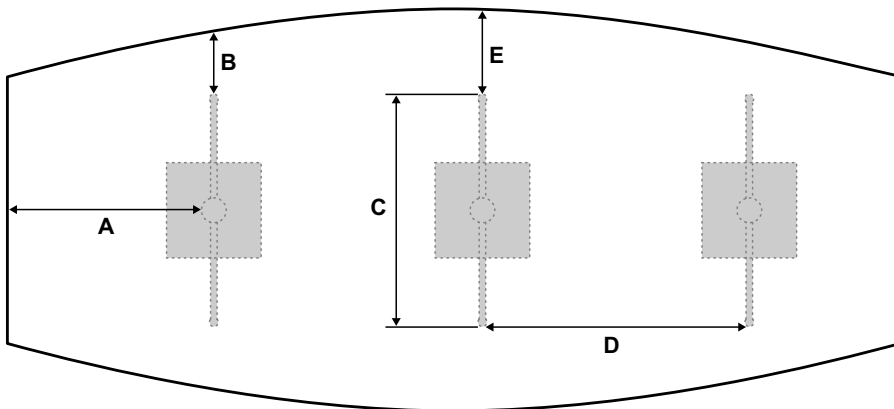

Top	A	B	C	D	E
36/54" x 120"	23 1/2"	8"	30"	35"	11 1/2"
36/54" x 132"	21 1/2"	7 1/2"	30"	43"	11 1/2"
36/54" x 144"	23 1/2"	7 1/2"	30"	47"	11 1/2"
40/60" x 156"	25 1/2"	10"	30"	51"	14 1/2"
40/60" x 168"	27 1/2"	10"	30"	55"	14 1/2"
40/60" x 180"	29 1/2"	10"	30"	59"	14 1/2"

Spyda-T Base

Four Bases

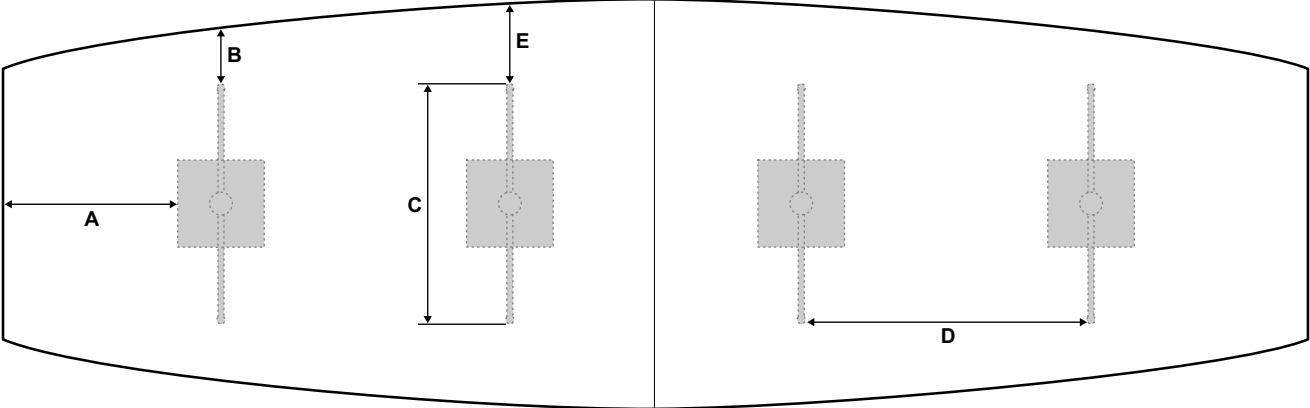

Top	A	B	C	D	E
44/60" x 192"	31 1/2"	8"	34"	41 1/2"	12"
44/60" x 204"	25"	7"	34"	50"	12"
44/60" x 216"	26 1/2"	7"	34"	53"	7"
44/60" x 240"	29 1/2"	7"	34"	59"	7"

Spyda-X Base

Single Base

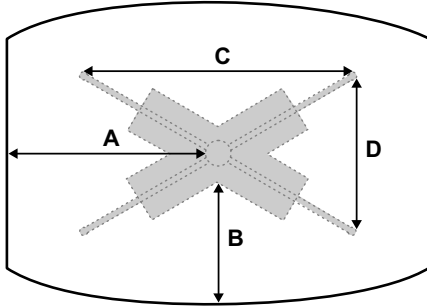

Top	A	B	C	D
24/30" x 42"	19"	13"	25 1/2"	15"
24/30" x 60"	29"	13"	29"	17"
28/36" x 72"	34"	16"	39 1/2"	23"
30/39" x 78"	37"	17 1/2"	39 1/2"	22 1/2"
30/42" x 84"	40"	19"	39 1/2"	23"

Two Bases

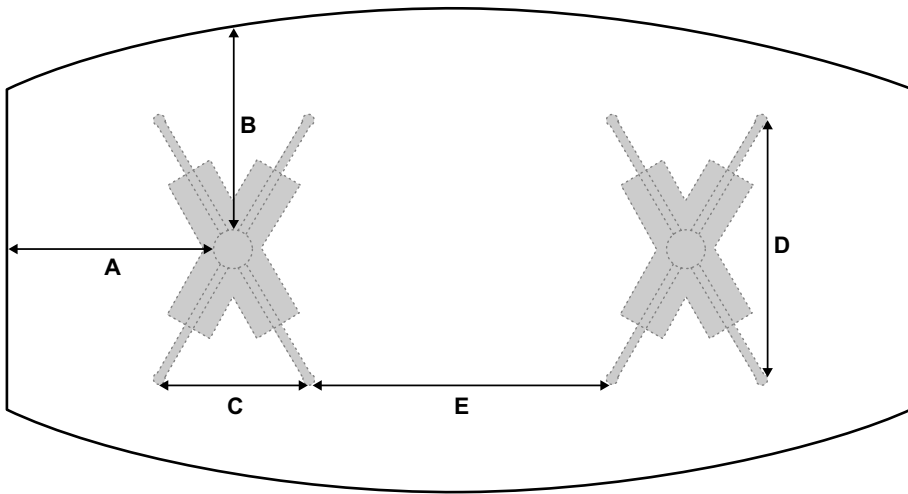

Top	A	B	C	D	E
32/48" x 90"	20 1/2"	20"	14"	26"	41"
32/48" x 96"	22"	20"	14"	26"	44"
34/52" x 108"	25"	22"	14"	26"	50"
36/54" x 120"	28"	20"	14"	26"	56"

Spyda-X Base

Two Bases with Center Base

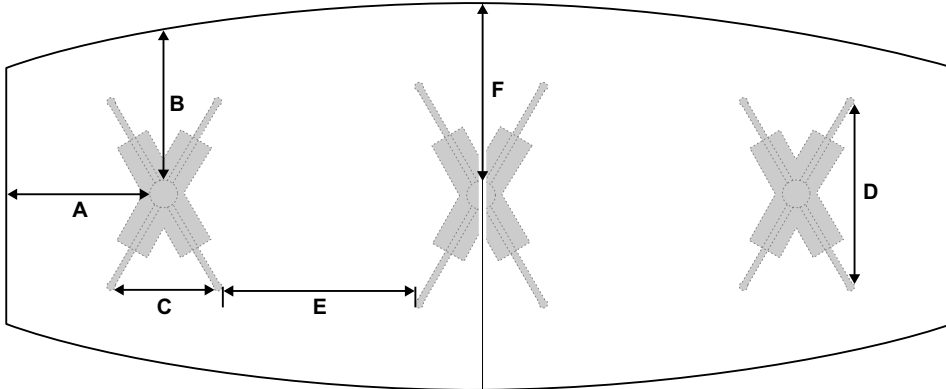

Top	A	B	C	D	E	F
36/54" x 132"	20"	21"	14"	26"	27"	25"
36/54" x 144"	22"	21"	14"	26"	31"	25"
40/60" x 156"	24"	23 ½"	14"	26"	35"	28"
40/60" x 168"	26"	23 ½"	14"	26"	39"	28"
40/60" x 180"	26"	23 ½"	14"	26"	43"	28"
40/60" x 192"	30"	23 ½"	14"	26"	47"	28"

Two Bases with Center Base

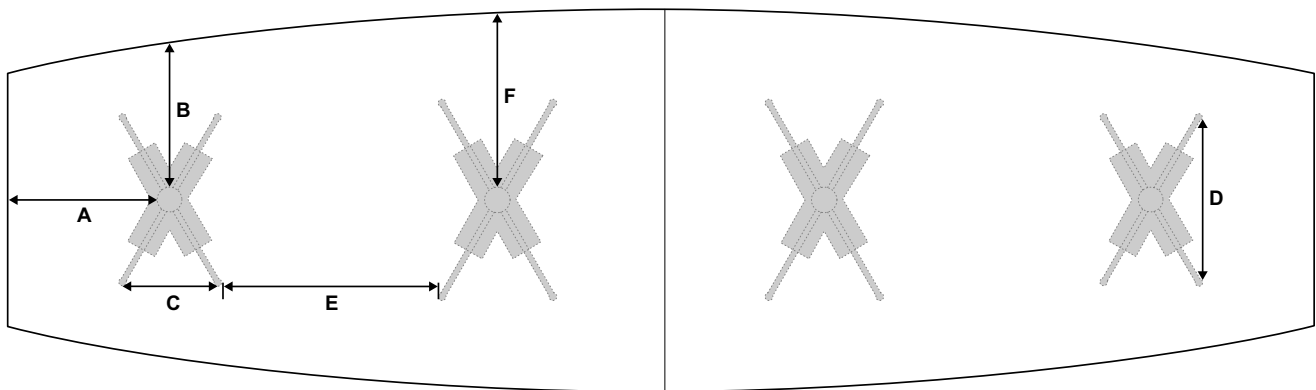

Top	A	B	C	D	E	F
40/60" x 204"	23 ½"	22 ½"	14"	26"	34"	27 ½"
40/60" x 216"	25"	22 ½"	14"	26"	37"	27"
40/60" x 240"	28"	22 ½"	14"	26"	43"	27 ½"

Spyda-Y Base

Two Base

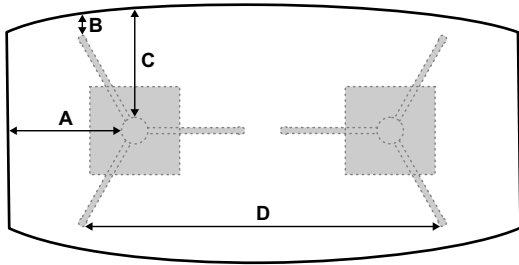

Top	A	B	C	D
28/36" x 72"	17 1/2"	2 1/2"	16 1/2"	50 1/2"
30/39" x 78"	19"	4"	18"	53 1/2"
30/42" x 84"	20 1/2"	4 1/2"	19"	56 1/2"
32/48" x 90"	22"	7"	21 1/2"	59 1/2"
32/48" x 96"	23 1/2"	7"	21 1/2"	62 1/2"
34/52" x 108"	24 1/2"	9"	23"	68 1/2"
36/54" x 120"	29 1/2"	8"	24 1/2"	76 1/2"

Two Bases with Center Base

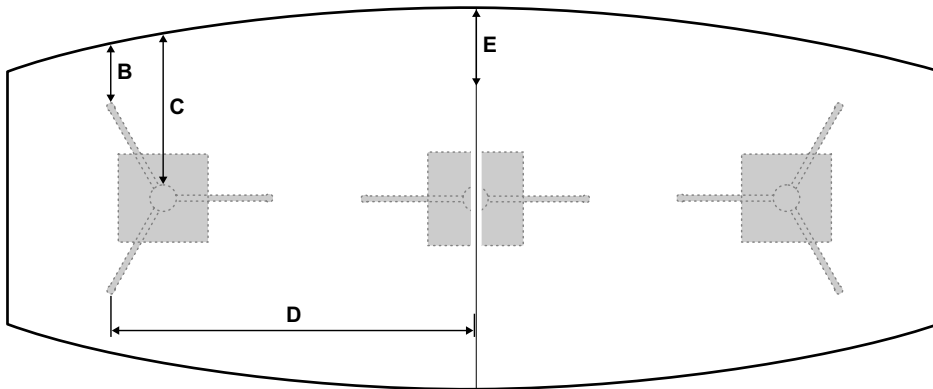

Top	A	B	C	D	E
36/54" x 132"	21 1/2"	8"	22 1/2"	51"	11 1/2"
36/54" x 144"	23 1/2"	8"	22 1/2"	55"	11 1/2"
40/60" x 156"	25 1/2"	10 1/2"	25"	58"	14 1/2"
40/60" x 168"	27 1/2"	11"	25"	62 1/2"	14 1/2"
40/60" x 180"	29 1/2"	11"	25"	66 1/2"	14 1/2"

Spyda-Y Base

Four Bases

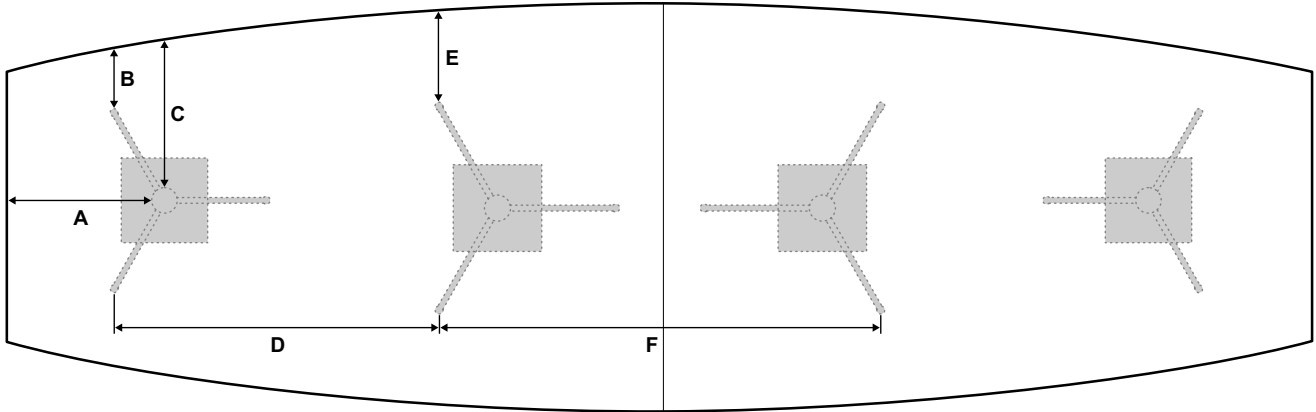

Top	A	B	C	D	E	F
40/60" x 192"	23 1/2"	9 1/2"	24"	46 1/2"	13 1/2"	64 1/2"
40/60" x 204"	25"	9 1/2"	24"	46 1/2"	13 1/2"	67 1/2"
40/60" x 216"	26 1/2"	10"	24"	52 1/2"	13 1/2"	70 1/2"
40/60" x 240"	29 1/2"	10"	24"	58 1/2"	13 1/2"	76 1/2"

Uffizi-Loop Base

Single Base

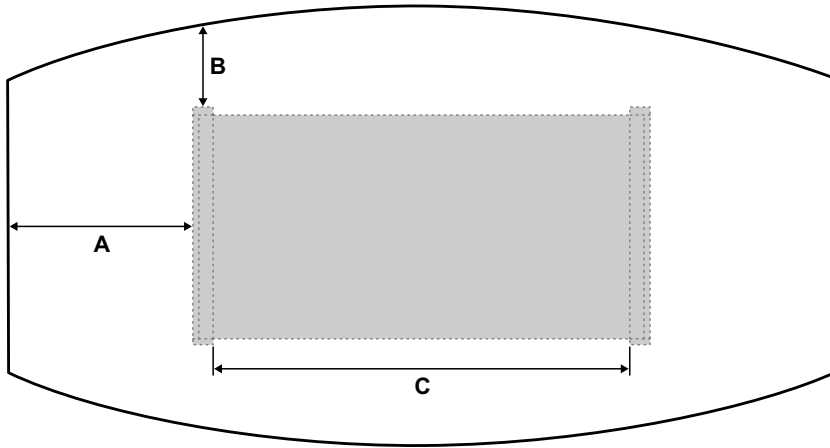

Top	A	B	C
32/48" x 90"	20"	9"	45"
32/48" x 96"	20"	8 ½"	51"
34/52" x 108"	20"	9 ½"	63"
36/54" x 120"	20"	10 ½"	75"

Two Bases with Center Base

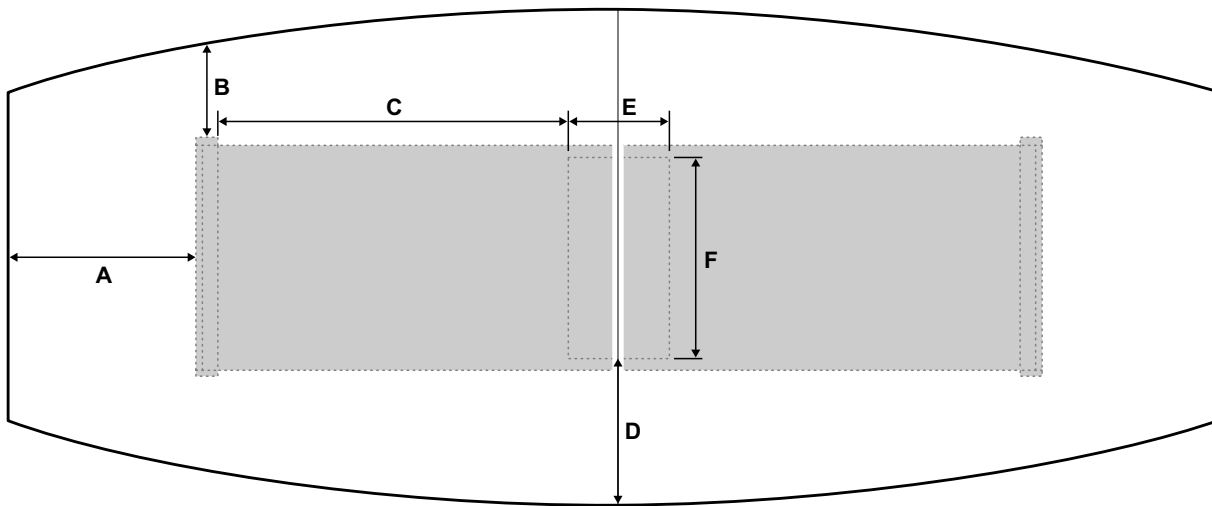

Top	A	B	C	D	E	F
36/54" x 132"	20"	10"	38"	19"	11"	22"
36/54" x 144"	20"	9 ½"	46"	19"	11"	22"
40/60" x 156"	20"	11 ½"	50"	19"	11"	22"
40/60" x 168"	20"	11"	56"	19"	11"	22"
40/60" x 180"	20"	11"	62"	19"	11"	22"
40/60" x 192"	20"	11"	68"	19"	11"	22"
40/60" x 204"	20"	10 ½"	74"	19"	11"	22"
40/60" x 216"	20"	10 ½"	80"	19"	11"	22"
40/60" x 240"	20"	10"	92"	19"	11"	22"

Zi-A Base

Single Base

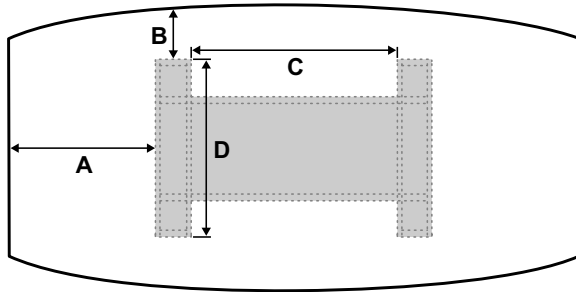

Top	A	B	C	D
30/39" x 78"	20"	6 1/2"	29"	24 1/2"
30/42" x 84"	20"	7 1/2"	35"	24 1/2"
32/48" x 90"	20"	10"	41"	24 1/2"
32/48" x 96"	20"	9 1/2"	47"	24 1/2"
34/52" x 108"	20"	11"	59"	24 1/2"
36/54" x 120"	20"	10"	71"	27 1/2"

Two Bases with Center Base

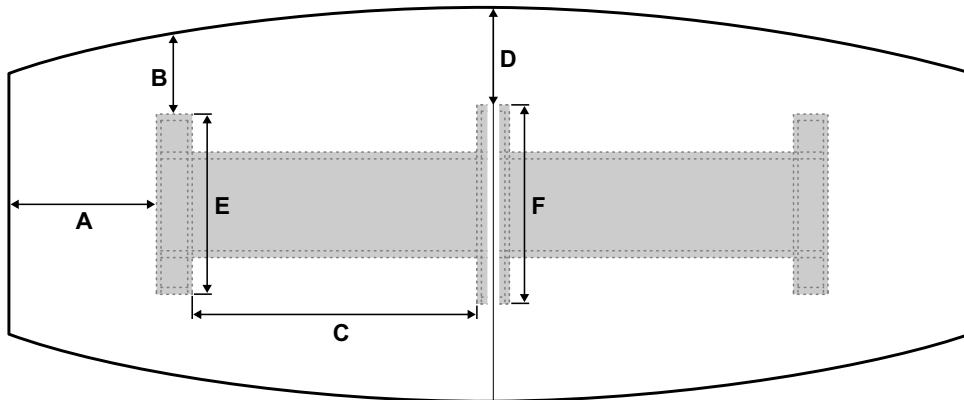

Top	A	B	C	D	E	F
36/54" x 132"	24"	11"	39 1/2"	27"	24 1/2"	27"
36/54" x 144"	24"	10 1/2"	45 1/2"	27 1/2"	24 1/2"	27"
40/60" x 156"	24"	11"	51 1/2"	30 1/2"	27 1/2"	30"
40/60" x 168"	24"	11"	57 1/2"	30 1/2"	27 1/2"	30"
40/60" x 180"	24"	10 1/2"	63 1/2"	30 1/2"	27 1/2"	30"
40/60" x 192"	24"	10 1/2"	69 1/2"	30 1/2"	27 1/2"	30"

Zi-A Base

Four Bases

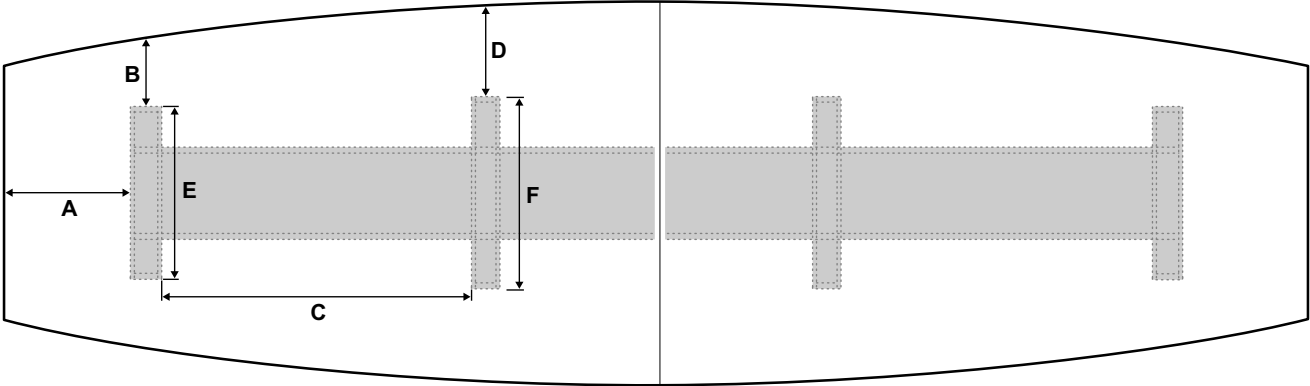

Top	A	B	C	D	E	F
40/60" x 204"	19 1/2"	10"	49"	14"	27 1/2"	30"
40/60" x 216"	19 1/2"	10"	53"	14"	27 1/2"	30"
40/60" x 240"	19 1/2"	9 1/2"	61"	14"	27 1/2"	30"

Zi-D Base

Single Base

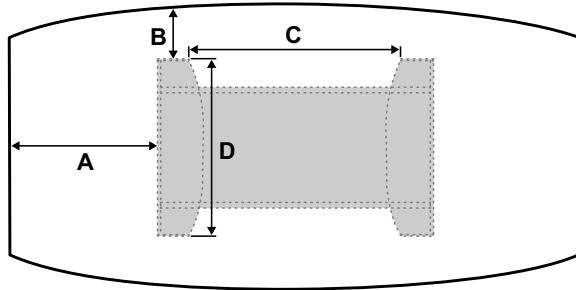

Top	A	B	C	D
30/39" x 78"	20"	6 ½"	29"	24 ½"
30/42" x 84"	20"	7 ½"	35"	24 ½"
32/48" x 90"	20"	10"	41"	24 ½"
32/48" x 96"	20"	9 ½"	47"	24 ½"
34/52" x 108"	20"	10 ½"	59"	24 ½"
36/54" x 120"	20"	10"	71"	27 ½"

Two Bases with Center Base

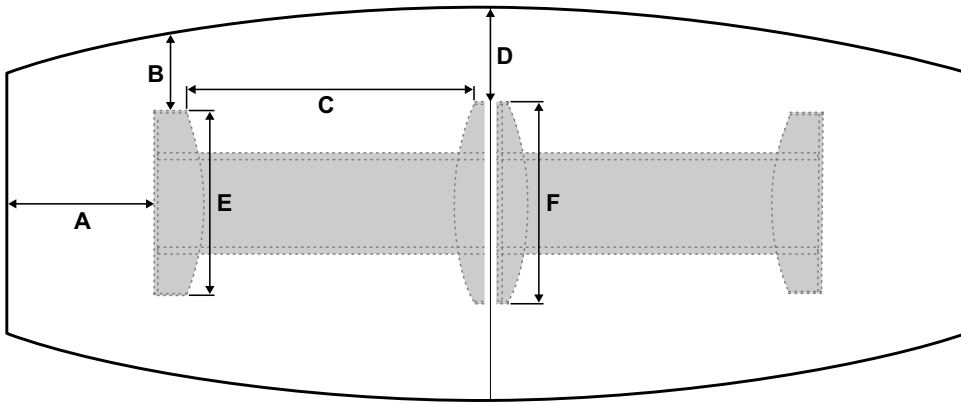

Top	A	B	C	D	E	F
36/54" x 132"	20"	11"	39 ½"	13 ½"	24 ½"	27"
36/54" x 144"	20"	10 ½"	45 ½"	13 ½"	24 ½"	27"
40/60" x 156"	20"	11 ½"	51 ½"	15"	27 ½"	30"
40/60" x 168"	20"	11"	57 ½"	15"	27 ½"	30"
40/60" x 180"	20"	10 ½"	63 ½"	15"	27 ½"	30"
40/60" x 192"	20"	10 ½"	69 ½"	15"	27 ½"	30"

Zi-D Base

Four Bases

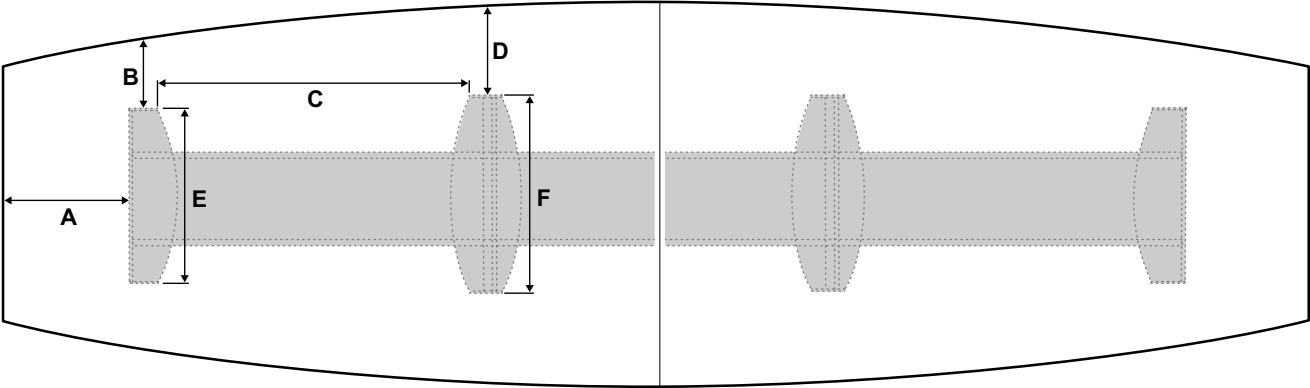

Top	A	B	C	D	E	F
40/60" x 204"	19 1/2"	10"	49"	14"	27 1/2"	30"
40/60" x 216"	19 1/2"	10"	53"	14"	27 1/2"	30"
40/60" x 240"	19 1/2"	9 1/2"	61"	14"	27 1/2"	30"

Ellipse Kneespace

Based on the Shape and Edge Detail chosen, the following pages highlight the kneespace of each viable to Base configuration.

Coda-Vee Base

Single Base

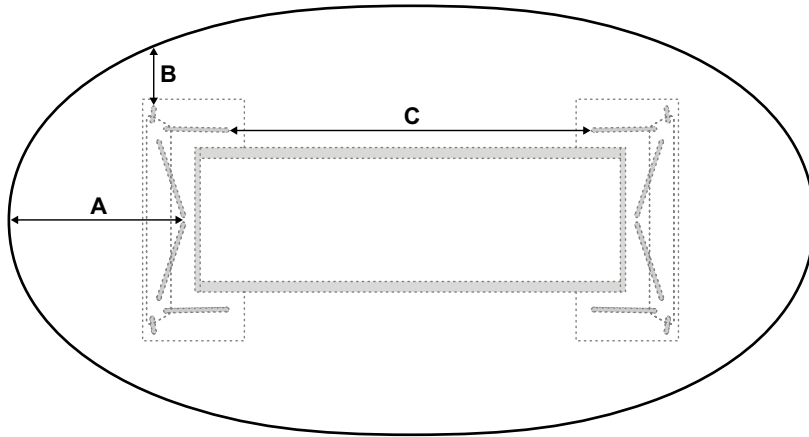

Top	A	B	C
48" x 90"	19"	6 ½"	41 ½"
48" x 96"	19"	7 ½"	47 ½"
52" x 108"	19"	8 ½"	59 ½"
54" x 120"	19"	9"	71 ½"

Two Bases with Center Base

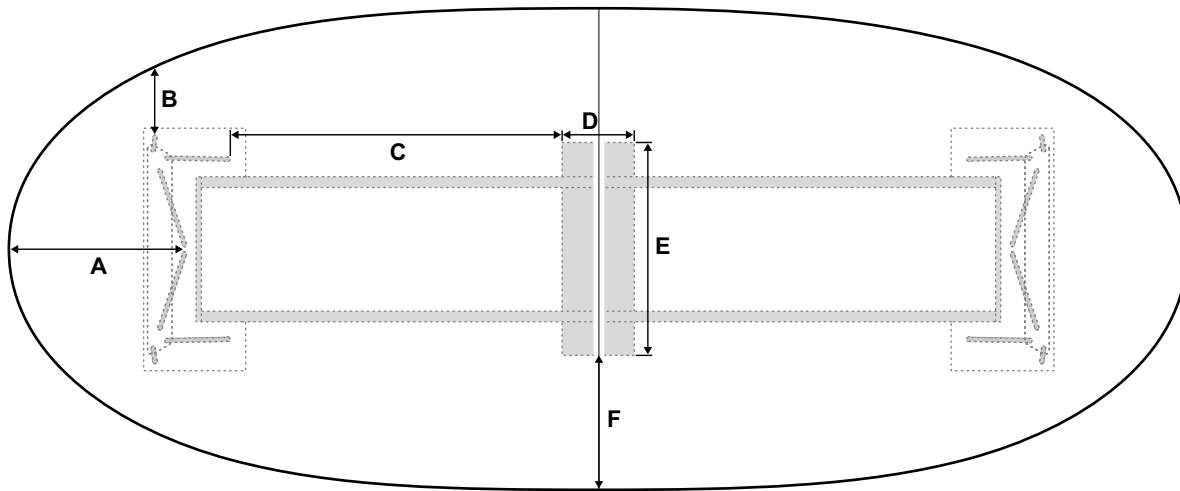

Top	A	B	C	D	E	F
54" x 132"	19"	7 ½"	38"	8"	24"	15"
54" x 144"	19"	8 ½"	44"	8"	24"	15"
60" x 156"	19"	10"	50"	8"	24"	18"
60" x 168"	19"	10"	56"	8"	24"	18"
60" x 180"	19"	9 ½"	62"	8"	24"	18"
60" x 192"	19"	9 ½"	68"	8"	27"	16 ½"
60" x 204"	19"	9 ½"	74"	8"	27"	16 ½"
60" x 216"	19"	7 ½"	80"	8"	27"	16 ½"
60" x 240"	19"	7 ½"	92"	8"	27"	16 ½"

Coda-Wire Base

Two Bases

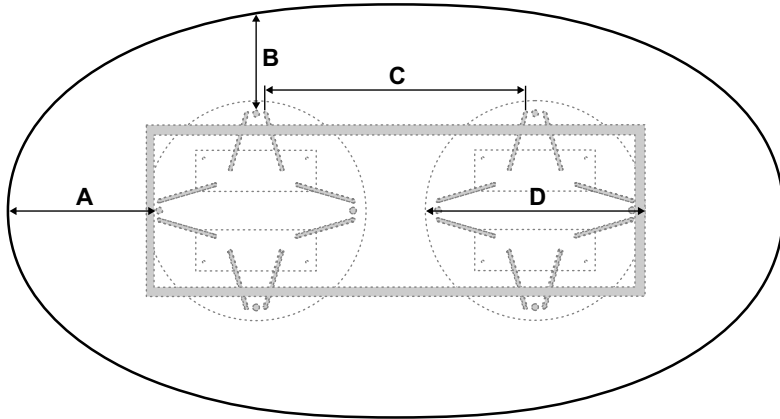

Top	A	B	C	D
36/48" x 90"	17"	10 ½"	8 ½"	25 ½"
36/48" x 96"	17"	10 ½"	8"	25 ½"
36/48" x 108"	17"	11"	8"	25 ½"
40/52" x 120"	17"	13"	10"	25 ½"
40/52" x 132"	17"	13"	9 ½"	25 ½"
40/52" x 144"	17"	13"	9 ½"	25 ½"

Two Bases with Center Base

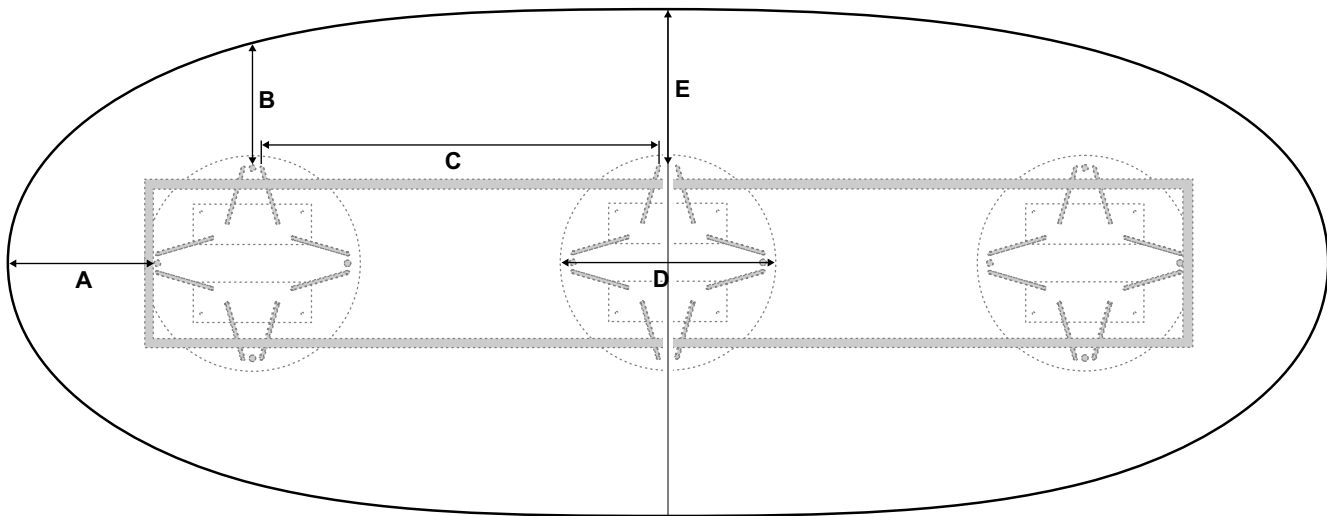

Top	A	B	C	D	E
44/56" x 156"	17"	15 ½"	13 ½"	11 ½"	25 ½"
44/56" x 168"	17"	15 ½"	13 ½"	11 ½"	25 ½"
44/56" x 180"	17"	15 ½"	13 ½"	11 ½"	25 ½"
44/60" x 192"	17"	17"	14 ½"	11 ½"	25 ½"
44/60" x 204"	17"	17 ½"	14 ½"	11 ½"	25 ½"
44/60" x 216"	17"	17 ½"	14 ½"	11 ½"	25 ½"
44/60" x 240"	17"	17 ½"	14 ½"	11 ½"	25 ½"

Coda-X Base

Two Bases

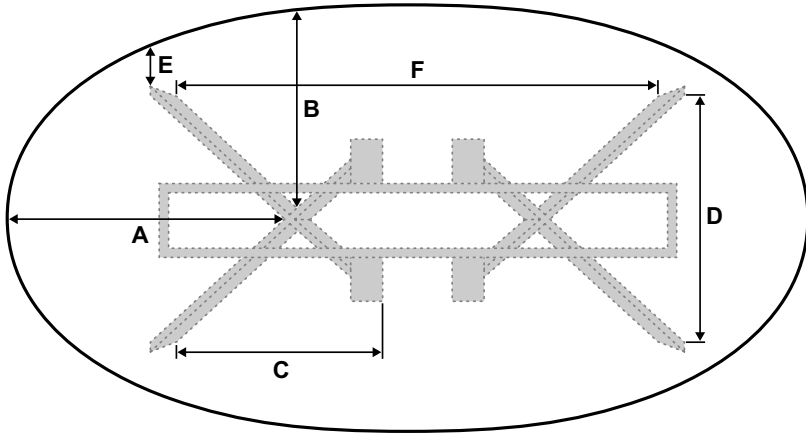

Top	A	B	C	D	E	F
48" x 90"	30"	22"	22 1/2"	27 1/2"	4"	53 1/2"
48" x 96"	30"	22"	22 1/2"	27 1/2"	4"	59 1/2"
52" x 108"	30"	23 1/2"	22 1/2"	27 1/2"	5"	71 1/2"
54" x 120"	30"	24"	22 1/2"	27 1/2"	5 1/2"	83 1/2"

Two Bases with Center Base

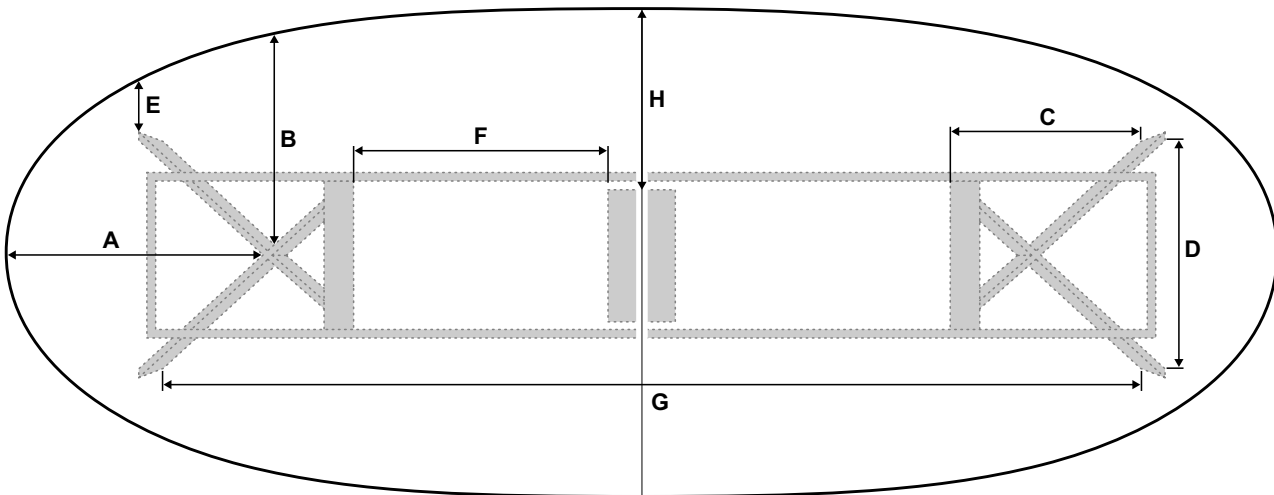

Top	A	B	C	D	E	F	G	H
54" x 132"	30"	24"	22 1/2"	27 1/2"	5"	21"	95 1/2"	19"
54" x 144"	30"	24"	22 1/2"	27 1/2"	5"	27"	107 1/2"	19"
60" x 156"	30"	25"	22 1/2"	27 1/2"	6 1/2"	33"	119 1/2"	22"
60" x 168"	30"	24 1/2"	22 1/2"	27 1/2"	6 1/2"	39"	131 1/2"	22"
60" x 180"	30"	24"	22 1/2"	27 1/2"	6"	45"	143 1/2"	22"
60" x 192"	30"	23"	22 1/2"	27 1/2"	6"	51"	155 1/2"	22"
60" x 204"	30"	21 1/2"	22 1/2"	27 1/2"	4 1/2"	57"	167 1/2"	22"
60" x 216"	30"	21 1/2"	22 1/2"	27 1/2"	4 1/2"	63"	179 1/2"	22"
60" x 240"	30"	21"	22 1/2"	27 1/2"	4 1/2"	75"	203 1/2"	22"

Cylinder Base

Two Bases

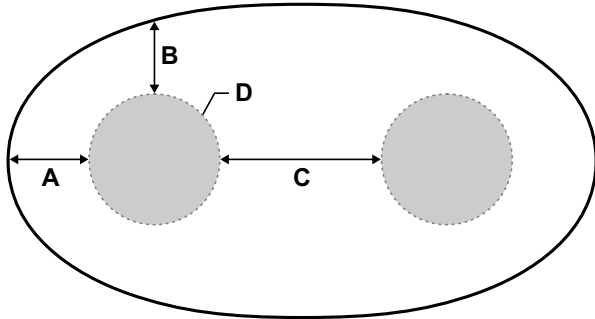

Top	A	B	C	D
48" x 90"	12 ½"	12 ½"	25"	20"
48" x 96"	14"	12 ½"	28"	20"
52" x 108"	17"	12 ½"	34"	20"
54" x 120"	18"	14 ½"	36"	24"

Two Bases with Center Base

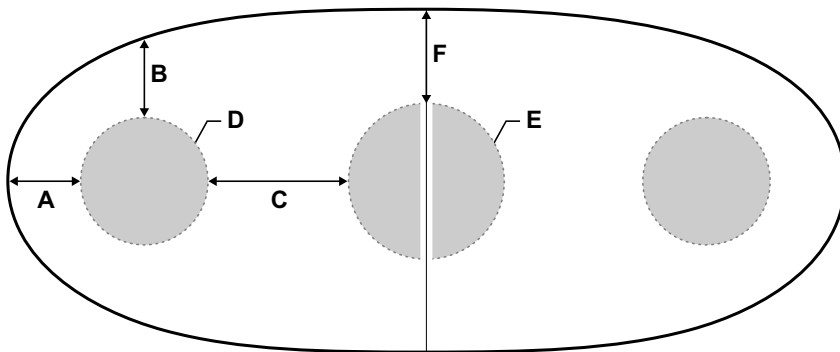

Top	A	B	C	D	E	F
54" x 132"	12"	12 ½"	22"	20"	24"	15"
54" x 144"	14"	13"	26"	20"	24"	15"
60" x 156"	16"	15 ½"	30"	20"	24"	18"
60" x 168"	18"	15 ½"	34"	20"	24"	18"
60" x 180"	20"	15"	38"	20"	24"	18"
60" x 192"	22"	15"	42"	20"	24"	18"

Cylinder Base

Four Bases

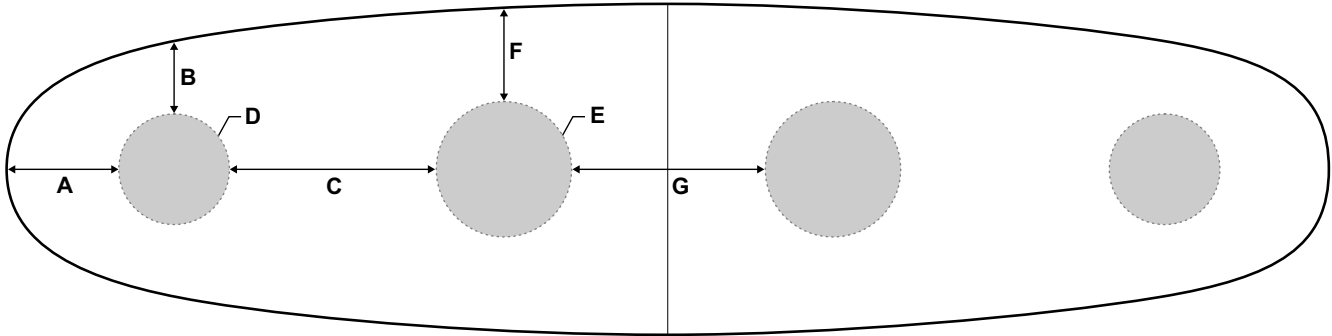

Top	A	B	C	D	E	F	G
60" x 204"	15 ½"	12"	29"	20"	24"	17"	27"
60" x 216"	17"	12"	32"	20"	24"	17"	30"
60" x 240"	20"	12 ½"	38"	20"	24"	17"	36"

Plinth Base

Two Bases

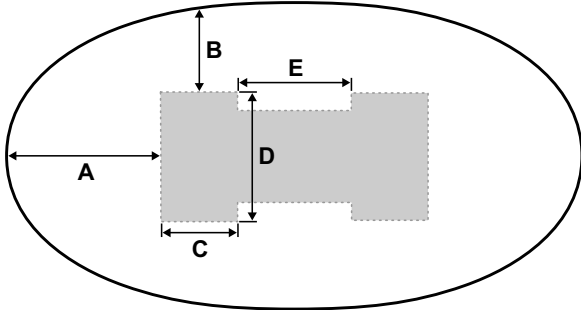

Top	A	B	C	D	E
48" x 90"	24"	13 1/2"	12"	20"	18"
48" x 96"	24"	13"	12"	20"	24"
52" x 108"	24"	14 1/2"	12"	20"	36"
54" x 120"	24"	15"	12"	20"	48"

Two Bases with Center Base

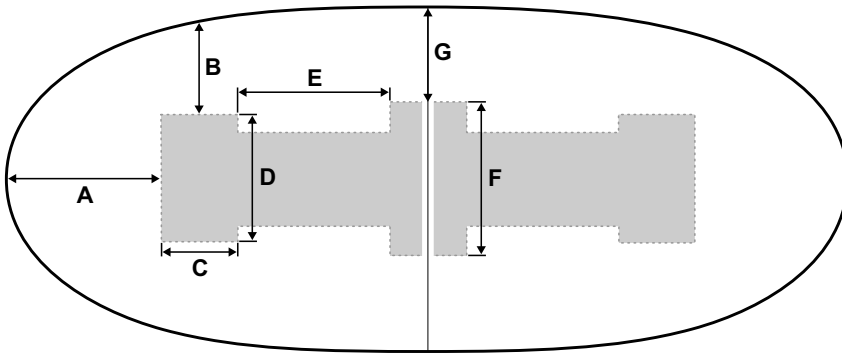

Top	A	B	C	D	E	F	G
54" x 132"	24"	14 1/2"	12"	20"	24"	24"	15"
54" x 144"	24"	14"	12"	20"	30"	24"	15"
60" x 156"	24"	16 1/2"	12"	20"	36"	24"	18"
60" x 168"	24"	15 1/2"	12"	20"	42"	24"	18"
60" x 180"	24"	15"	12"	20"	48"	24"	18"
60" x 192"	24"	14 1/2"	12"	20"	54"	24"	18"

Plinth Base

Four Bases

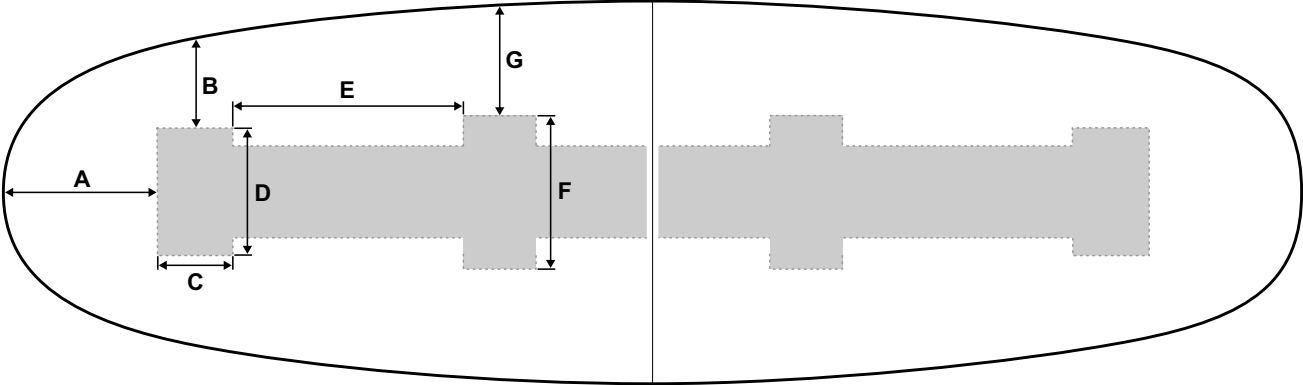

Top	A	B	C	D	E	F	G
60" x 204"	24"	12 1/2"	12"	20"	36"	24"	17"
60" x 216"	24"	12 1/2"	12"	20"	40"	24"	17"
60" x 240"	24"	12"	12"	20"	48"	24"	17"

Ryvit Base

Single Base

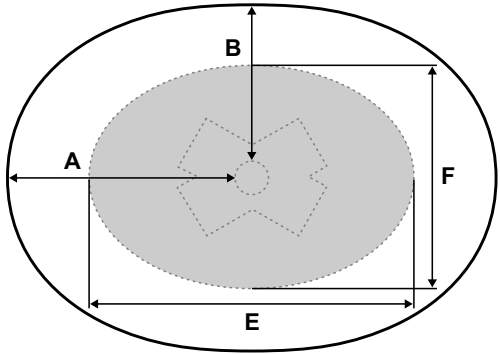

Top	A	B	E	F
30" x 42"	19 1/2"	13 1/2"	28"	19"
30" x 60"	28 1/2"	13 1/2"	32"	22"
36" x 72"	32 1/2"	16 1/2"	32"	22"

Two Bases

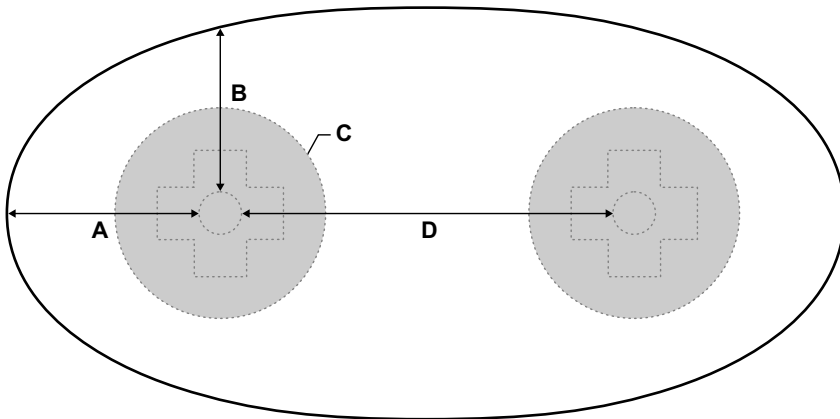

Top	A	B	C	D
39" x 78"	17 1/2"	16"	20"	35"
42" x 84"	19"	17 1/2"	20"	38"
48" x 90"	20 1/2"	20"	26"	41"
48" x 96"	22"	20"	26"	44"
52" x 108"	25"	22"	26"	50"
54" x 120"	30"	23"	26"	55"

Ryvit Base

Two Bases with Center Base

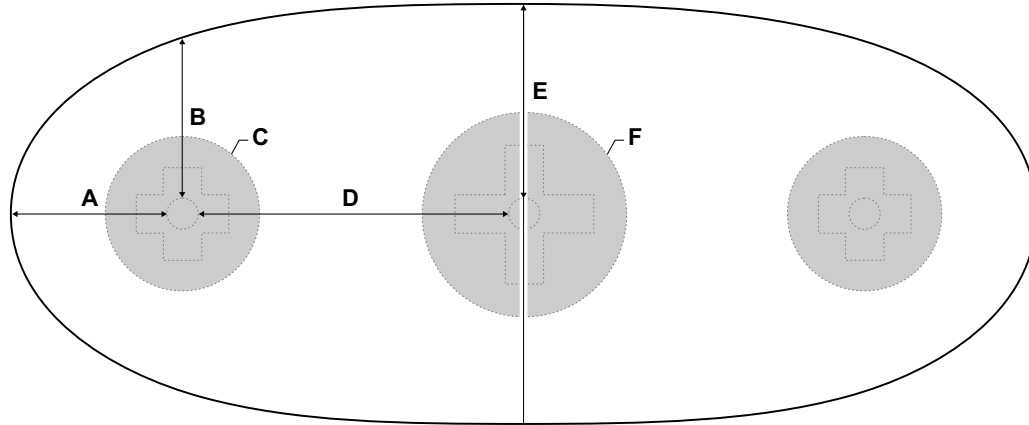

Top	A	B	C	D	E	F
54" x 132"	20"	20 ½"	20"	40"	25"	26"
54" x 144"	22"	21"	20"	44"	25"	26"
60" x 156"	24"	23 ½"	20"	48"	28"	26"
60" x 168"	26"	23 ½"	20"	52"	28"	26"
60" x 180"	28"	23"	20"	56"	28"	26"
60" x 192"	30"	22 ½"	26"	60"	28"	30"

Four Bases

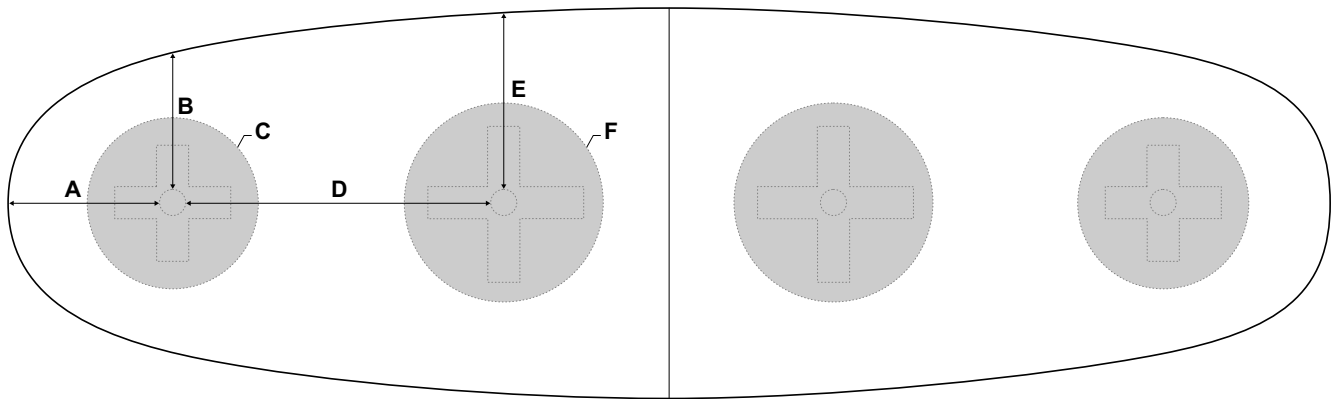

Top	A	B	C	D	E	F
60" x 204"	23 ½"	20"	26"	47"	27"	30"
60" x 216"	25"	20"	26"	50"	27"	30"
60" x 240"	28"	20"	26"	56"	27"	30"

Spyda-T Base

Two Bases

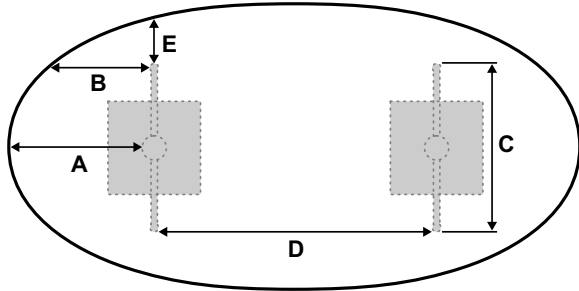

Top	A	B	C	D	E
39" x 78"	19"	14"	22"	38"	6 ½"
42" x 84"	20"	16"	22"	41 ½"	8"
48" x 90"	22"	16"	26"	44"	8 ½"
48" x 96"	23 ½"	18"	26"	47"	8 ½"
52" x 108"	26 ½"	21 ½"	26"	53"	10 ½"

Two Bases with Center Base

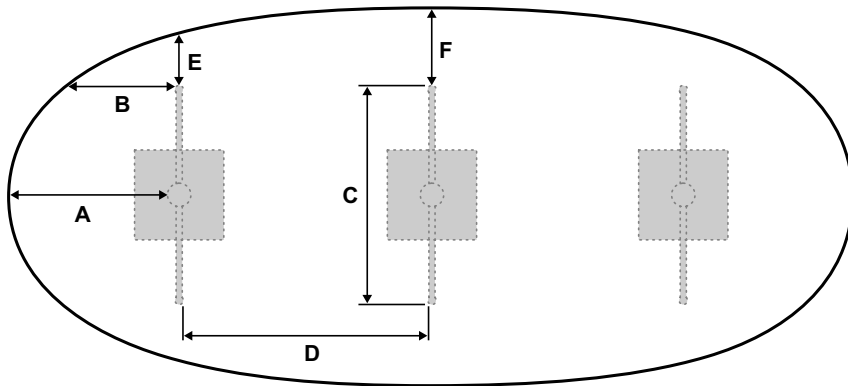

Top	A	B	C	D	E	F
54" x 120"	23 ½"	16 ½"	30"	35"	8"	11 ½"
54" x 132"	23 ½"	14 ½"	30"	42 ½"	7"	11 ½"
54" x 144"	23 ½"	16 ½"	30"	47"	7"	11 ½"
60" x 156"	23 ½"	19 ½"	30"	51"	10"	14 ½"
60" x 168"	27 ½"	21 ½"	30"	55"	10"	14 ½"
60" x 180"	29 ½"	23 ½"	30"	59"	9 ½"	14 ½"

Spyda-T Base

Four Bases

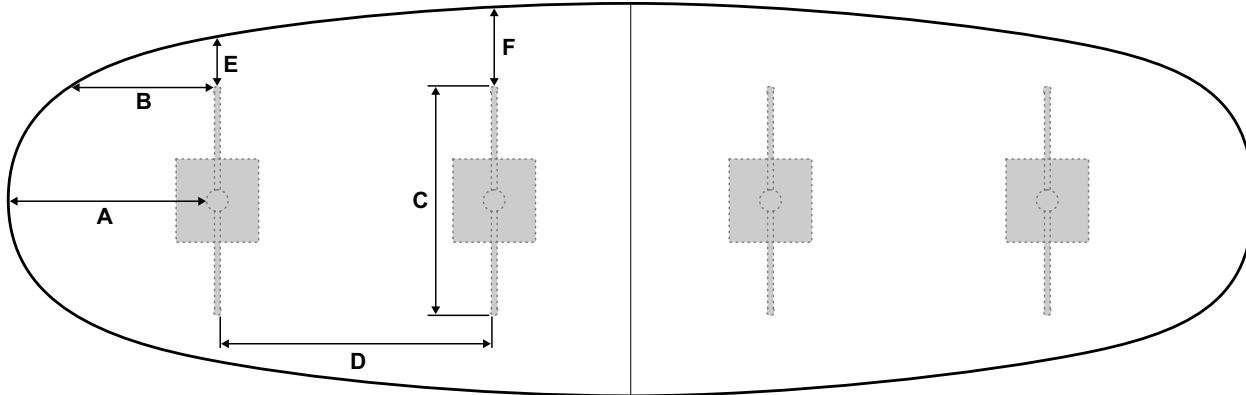

Top	A	B	C	D	E	F
60" x 192"	31 1/2"	23 1/2"	34"	41 1/2"	7"	12"
60" x 204"	25"	15 1/2"	34"	50"	4 1/2"	11 1/2"
60" x 216"	25"	17"	34"	53"	4 1/2"	11 1/2"
60" x 240"	29 1/2"	20"	34"	59"	4 1/2"	11 1/2"

Spyda-X Base

Single Base

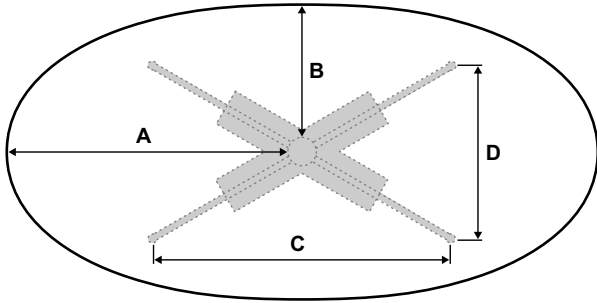

Top	A	B	C	D
30" x 60"	27"	13"	29 1/2"	16 1/2"
36" x 72"	34"	16"	39 1/2"	22 1/2"
39" x 78"	37"	17 1/2"	40"	22 1/2"
42" x 84"	40"	19"	40"	23"

Two Bases

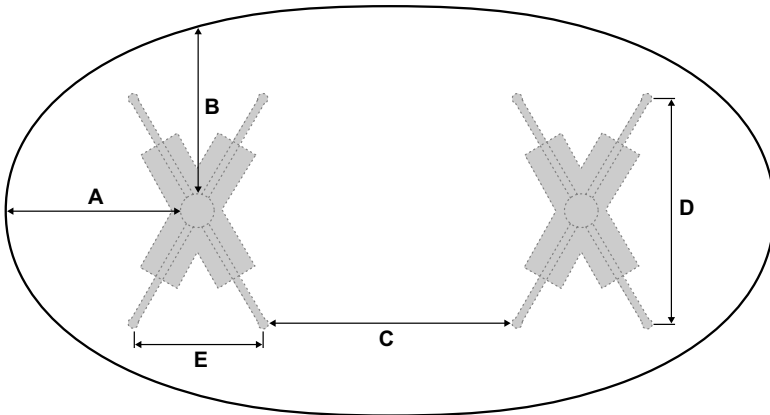

Top	A	B	C	D	E
48" x 90"	20 1/2"	20"	30"	26"	14"
48" x 96"	22"	20"	32"	26"	14"
52" x 108"	25"	22"	38"	26"	14"
54" x 120"	28"	23"	42"	26"	14"

Spyda-X Base

Two Bases with Center Base

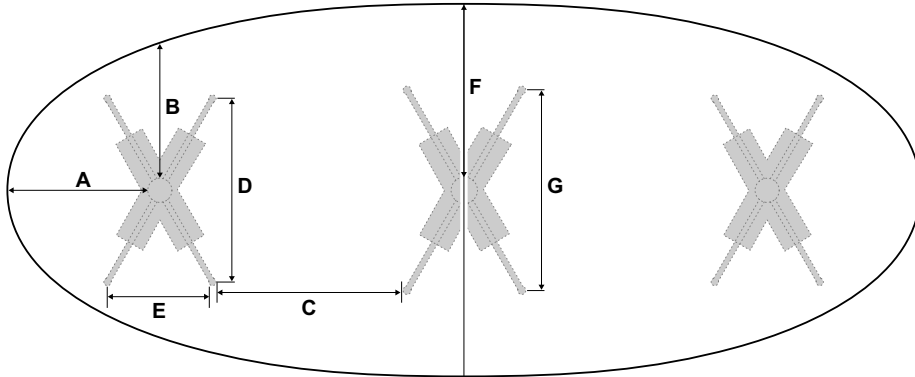

Top	A	B	C	D	E	F	G	H
40/52" x 132"	20"	23"	27 1/2"	26"	14"	26 1/2"	30"	16"
40/52" x 144"	22"	23"	31"	26"	14"	26"	30"	16"
40/56" x 156"	24"	25"	35"	26"	14"	26"	30"	16"
40/56" x 168"	26"	25"	39"	26"	14"	26"	30"	16"
40/56" x 180"	28"	25"	43"	26"	14"	26"	30"	16"
40/60" x 192"	30"	26 1/2"	47"	26"	14"	26 1/2"	30"	16"

Two Bases with Center Base

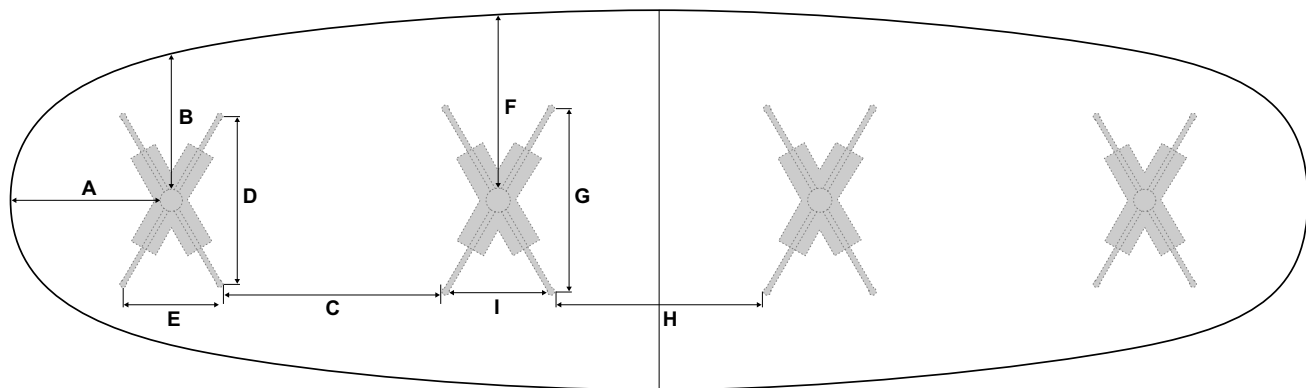

Top	A	B	C	D	E	F	G	H	I
44/60" x 204"	23 1/2"	20"	34"	26"	14"	27"	30"	33"	16"
40/60" x 216"	25"	20"	37"	26"	14"	27"	30"	36"	16"
40/60" x 240"	28"	20"	43"	26"	14"	27"	30"	42"	16"

Spyda-Y Base

Two Base

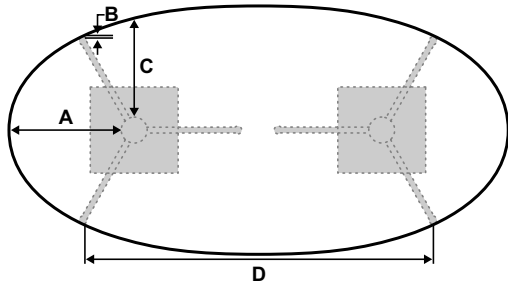

Top	A	B	C	D
36" x 72"	17 ½"	½"	16"	50 ½"
39" x 78"	19"	1 ½"	17 ½"	53 ½"
42" x 84"	20 ½"	3"	19"	56 ½"
48" x 90"	22"	5 ½"	21 ½"	59 ½"
48" x 96"	23 ½"	6"	21 ½"	62 ½"
52" x 108"	26 ½"	8 ½"	23 ½"	68 ½"
54" x 120"	29 ½"	7 ½"	24 ½"	76 ½"

Two Bases with Center Base

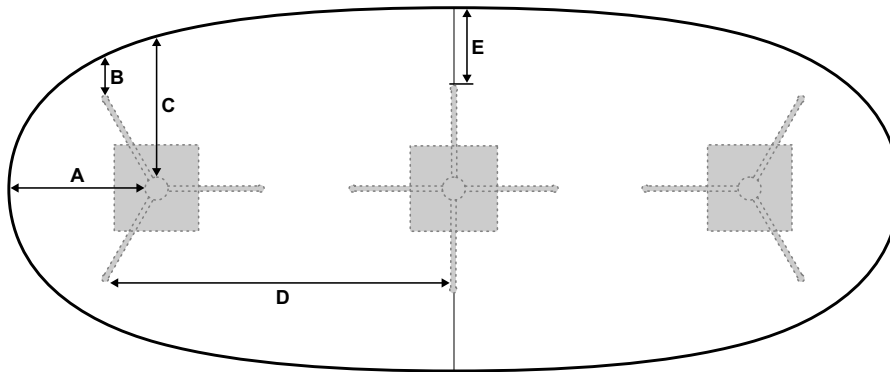

Top	A	B	C	D	E
54" x 132"	21 ½"	6"	22"	51"	11 ½"
54" x 144"	23 ½"	7"	22 ½"	55"	11 ½"
60" x 156"	25 ½"	9 ½"	25"	59"	14 ½"
60" x 168"	27 ½"	10"	25"	63"	14 ½"
60" x 180"	29 ½"	10"	24 ½"	67"	14 ½"

Spyda-Y Base

Four Bases

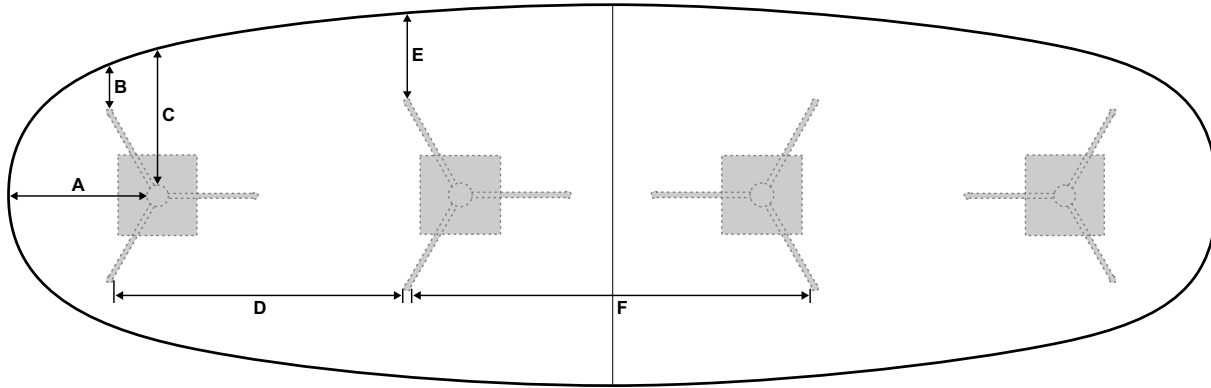

Top	A	B	C	D	E	F
60" x 192"	23 1/2"	8"	22 1/2"	46 1/2"	13 1/2"	64 1/2"
60" x 204"	25"	6 1/2"	21"	49 1/2"	13"	67 1/2"
60" x 216"	26 1/2"	7"	21 1/2"	52 1/2"	13"	70 1/2"
60" x 240"	29 1/2"	7 1/2"	21 1/2"	58 1/2"	13 1/2"	64 1/2"

Uffizi-Loop Base

Single Base

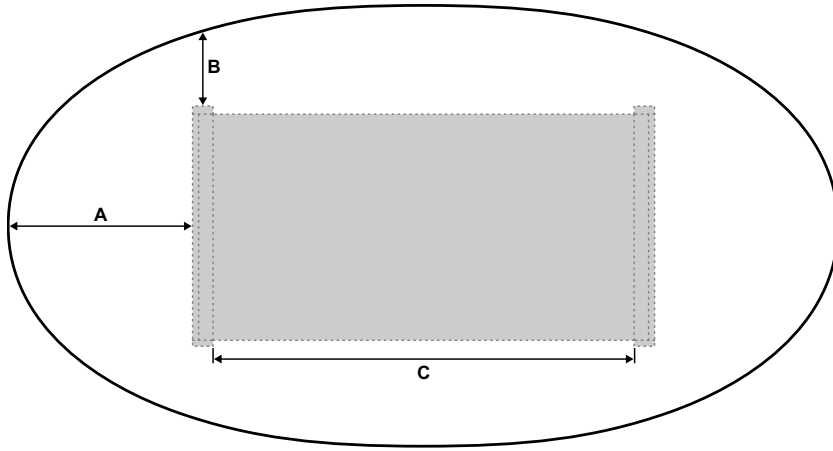

Top	A	B	C
48" x 90"	20"	8 ½"	45"
48" x 96"	20"	8 ½"	51"
52" x 108"	20"	9 ½"	63"
54" x 120"	20"	10"	75"

Two Bases with Center Base

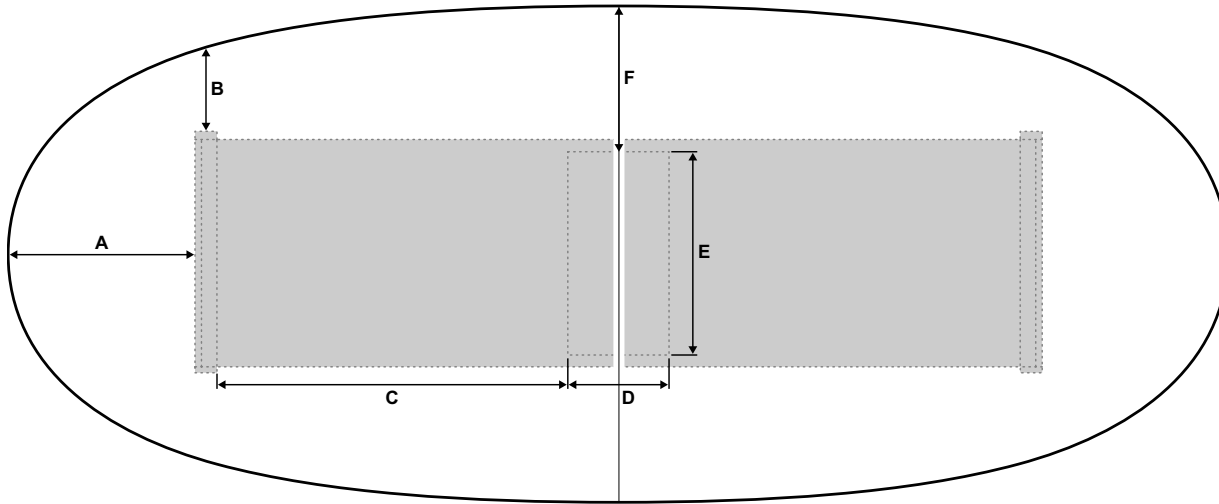

Top	A	B	C	D	E	F
54" x 132"	20"	9 ½"	38"	11"	22"	19"
54" x 144"	20"	9"	44"	11"	22"	19"
60" x 156"	20"	11"	50"	11"	22"	19"
60" x 168"	20"	10 ½"	56"	11"	22"	19"
60" x 180"	20"	10"	62"	11"	22"	19"
60" x 192"	20"	9 ½"	68"	11"	22"	19"
60" x 204"	20"	8"	74"	11"	22"	19"
60" x 216"	20"	7 ½"	80"	11"	22"	19"
60" x 240"	20"	7 ½"	92"	11"	22"	19"

Zi-A Base

Single Base

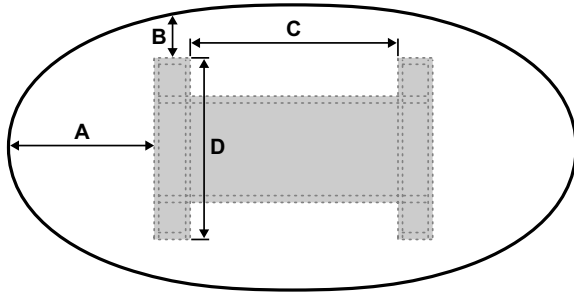

Top	A	B	C	D
39" x 78"	20"	6 ½"	29"	24 ½"
42" x 84"	20"	7 ½"	35"	24 ½"
48" x 90"	24"	10 ½"	33"	24 ½"
48" x 96"	24"	10 ½"	39"	24 ½"
52" x 108"	24"	11 ½"	51"	24 ½"
54" x 120"	24"	10 ½"	63"	27 ½"

Two Bases with Center Base

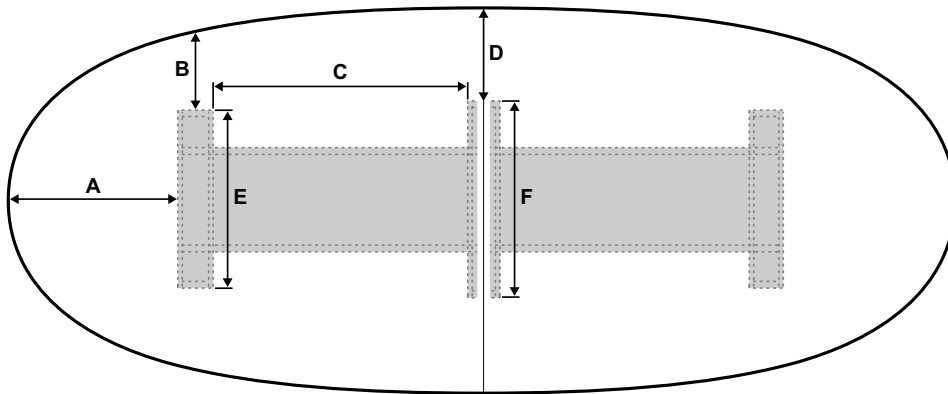

Top	A	B	C	D	E	F
54" x 132"	24"	12"	35 ½"	13 ½"	24 ½"	27"
54" x 144"	24"	11"	41 ½"	13 ½"	24 ½"	27"
60" x 156"	24"	12"	47 ½"	15"	27 ½"	30"
60" x 168"	24"	11"	53 ½"	15"	27 ½"	30"
60" x 180"	24"	10 ½"	59 ½"	15"	27 ½"	30"
60" x 192"	24"	10 ½"	65 ½"	15"	27 ½"	30"

Zi-A Base

Four Bases

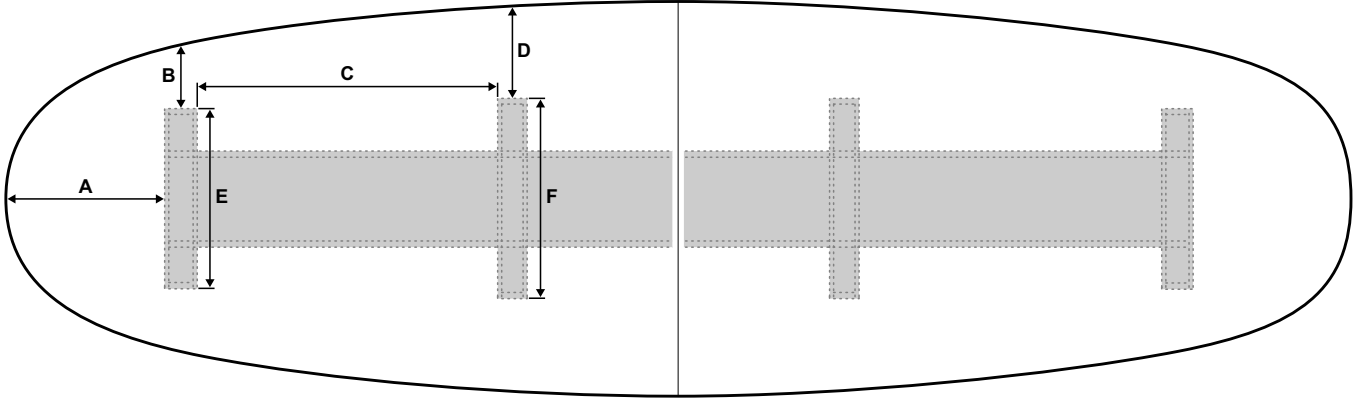

Top	A	B	C	D	E	F
60" x 204"	24"	8 1/2"	46"	14"	27 1/2"	30"
60" x 216"	24"	8"	50"	14"	27 1/2"	30"
60" x 240"	24"	8"	58"	14"	27 1/2"	30"

Zi-D Base

Single Base

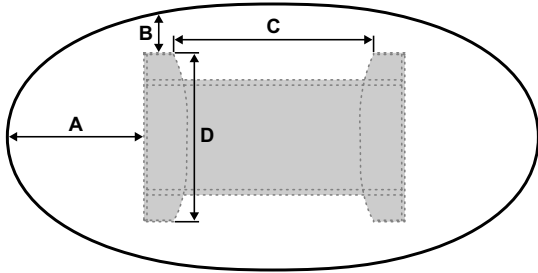

Top	A	B	C	D
39" x 78"	20"	6 ½"	29"	24 ½"
42" x 84"	20"	7 ½"	35"	24 ½"
48" x 90"	24"	10 ½"	33"	24 ½"
48" x 96"	24"	10 ½"	39"	24 ½"
52" x 108"	24"	11 ½"	51"	24 ½"
54" x 120"	24"	10 ½"	63"	27 ½"

Two Bases with Center Base

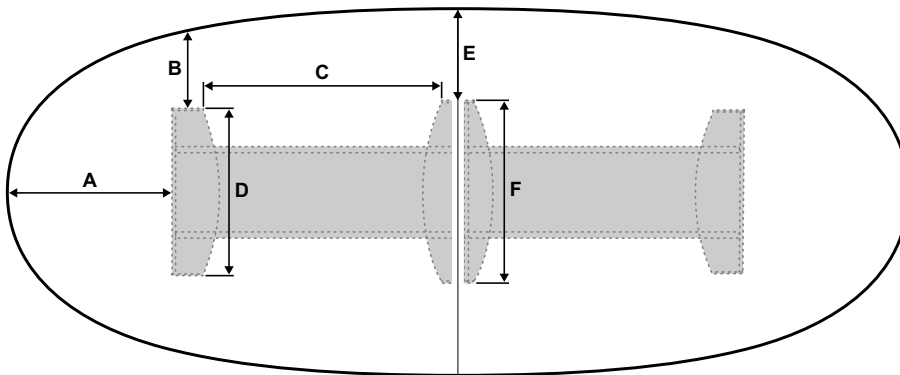

Top	A	B	C	D	E	F
54" x 132"	24"	12"	35 ½"	24 ½"	13 ½"	27"
54" x 144"	24"	11"	41 ½"	24 ½"	13 ½"	27"
60" x 156"	24"	12"	47 ½"	27 ½"	15"	30"
60" x 168"	24"	11 ½"	53 ½"	27 ½"	15"	30"
60" x 180"	24"	10 ½"	59 ½"	27 ½"	15"	30"
60" x 192"	24"	10"	65 ½"	27 ½"	15"	30"

Zi-D Base

Four Bases

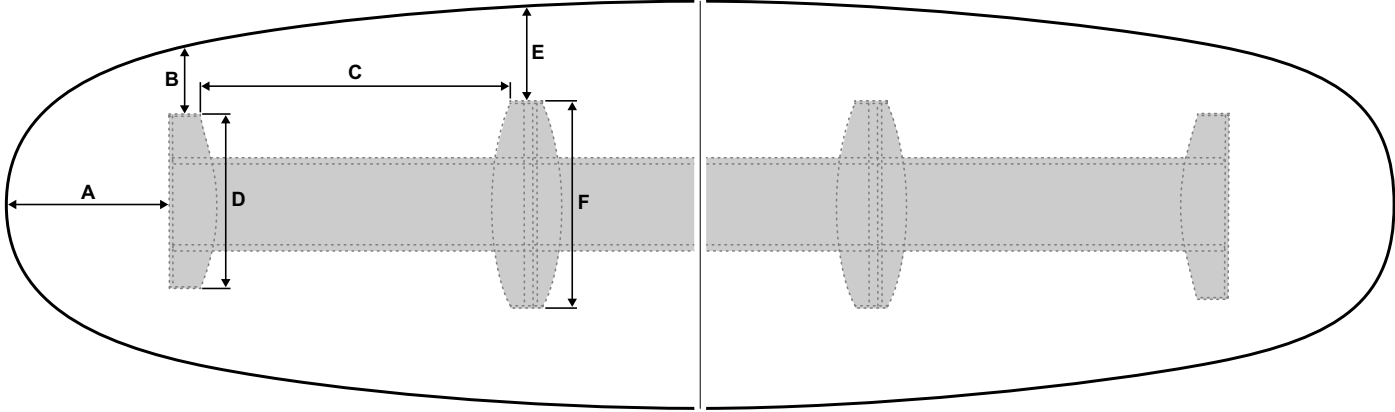

Top	A	B	C	D	E	F
60" x 204"	24"	8 1/2"	46"	27 1/2"	14"	30"
60" x 216"	24"	8"	50"	27 1/2"	14"	30"
60" x 240"	24"	8"	58"	27 1/2"	14"	30"

Power Options

Identifying the best power for the table will be determined by need and the base option chosen.



Power Options

There are two main types: Surface Power Units (5 options) and Perimeter Power (2 Options). The Zi base can also support: Data Units and Pop-Up Center.

Power locations for table shape & bases are identified in the following pages.

Surface Power Units

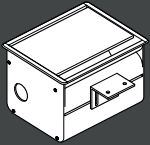

Power-Comm Troughs
(Single)

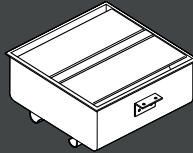

Power-Comm Troughs
(Dual)

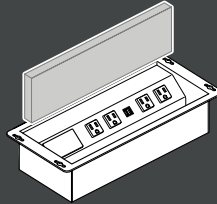

Power-Comm
Recessed Consoles
(GC & GCS)

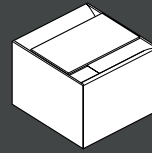

Boho

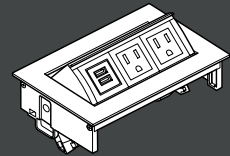

MhoB

Perimeter Power & Data Units

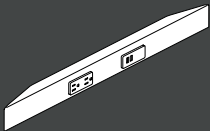

Power-Data Aprons

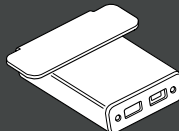

Garcia 2-Trac

All Base Styles

Recommended power units for Univers Base styles:

Surface Power Units

- Power-Comm Troughs - Single
- Power-Comm Troughs - Double
- Power Comm Recessed Consoles
- Boho
- MhoB

Perimeter Power

- Power Data Apron
- Garcia 2-trac

Power Aprons

- Power aprons are placed around the perimeter of the table and typically recessed 8" in from edge (may require less of a recess on smaller tops to avoid base interference).
- Recommended for Rectangle, Video, Boat and Square tops
- Not recommended for video tops 108" or less with Coda Vee base due to base interference
- Not recommended for Circle, Ellipse, or Track tops due to the curves of the shape

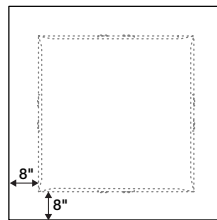
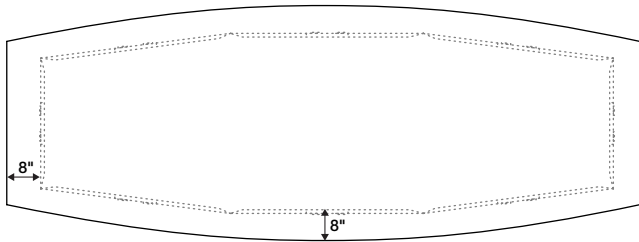
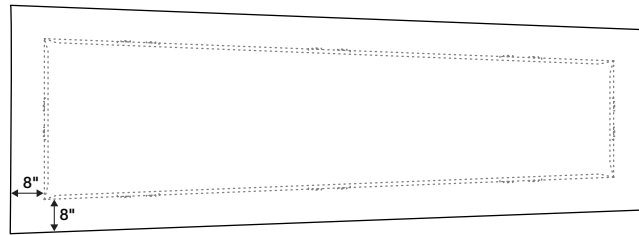
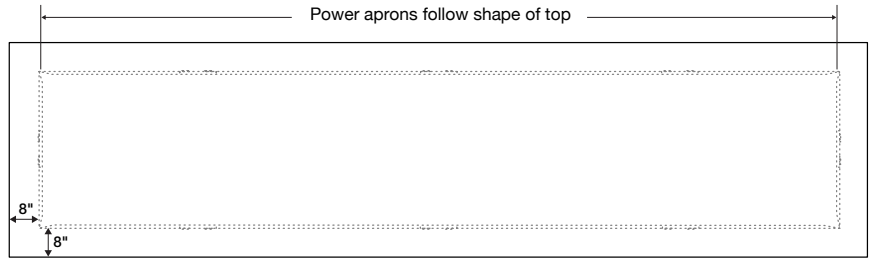

Power Comm Troughs

Power comm troughs cannot break into top sections more than 24". To allow a longer power comm trough, top must be sectioned further.

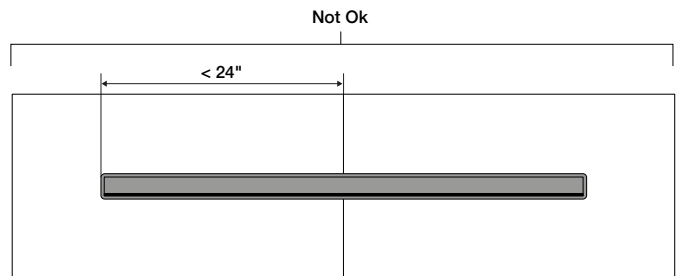
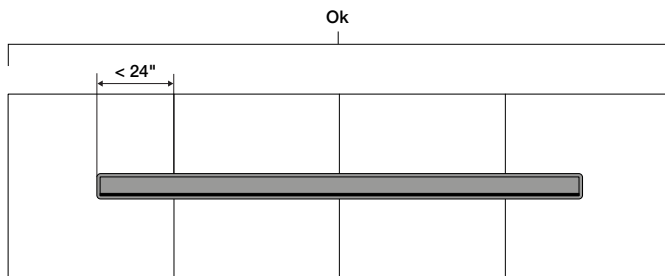

Coda-Vee

GC Interact, MhoB, Boho, 7" and 12" single or double Power-Comm Troughs can be oriented either way.

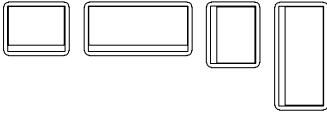

All single or double Power-Comm Troughs 18" or greater, all double Power-Comm Troughs and GC Interface units must be oriented this direction

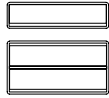

Tables 72" – 120" have no center plinth and require additional wire management options such as Cable Drop.

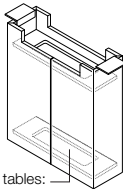

Tables 132" – 240" have a center plinth base that allows for wire management.

Cutout for tables:
132" x 180" = 15" x 4"
192" x 240" = 18" x 4"

Tuohy recommendations for recessed consoles for all shapes

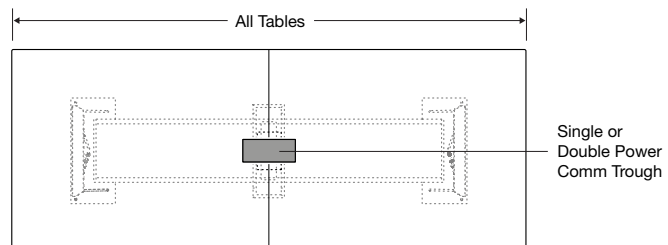
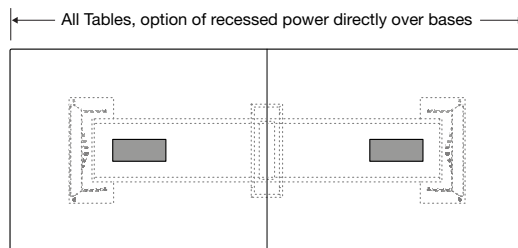
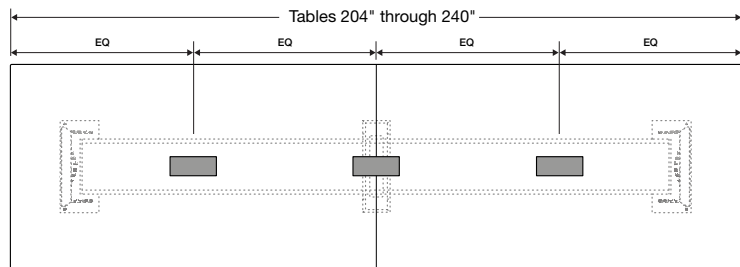
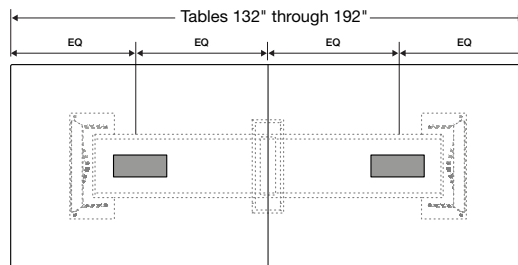
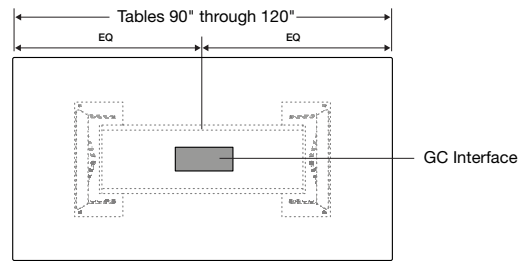
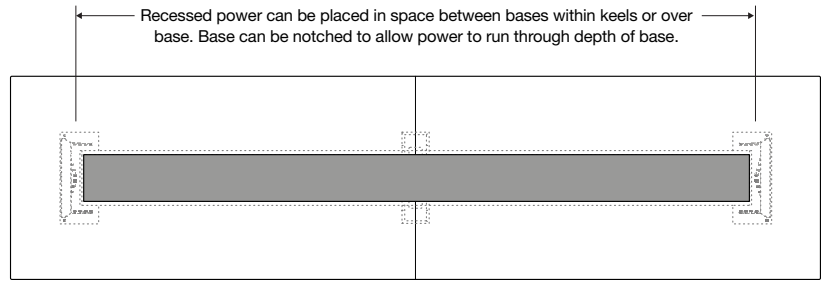

Coda-Wire

GC Interact, MhoB, Boho, 7" and 12" single Power-Comm Troughs can be oriented either way EXCEPT on 72" w Tables in which case ALL units EXCEPT the GC Interact must be orientated this way.

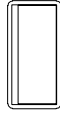

All single troughs 18" or greater, all double Power-Comm Troughs and GC Interface units must be oriented this direction.



Double troughs will not fit on tables 72" - 96". Troughs cannot extend the width of the Coda-Wire base tables due to interference.

No wire management through bases, they require additional wire management options such as a Cable Drop.

Tuohy recommendations for recessed consoles for all shapes

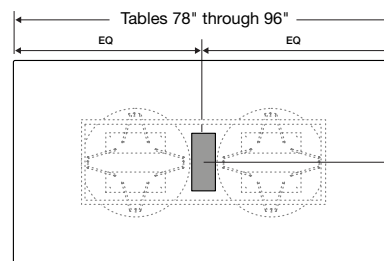
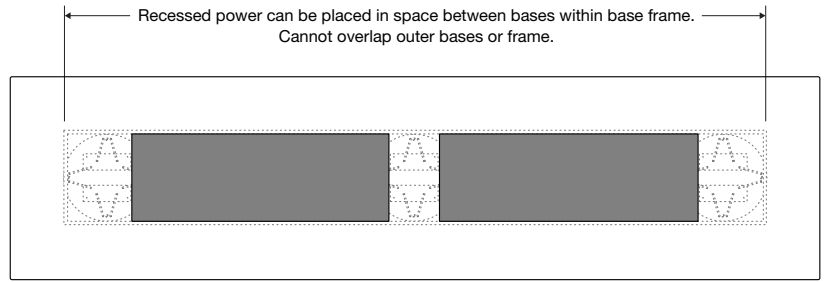

78"-96" single or double trough fit between mounting plates

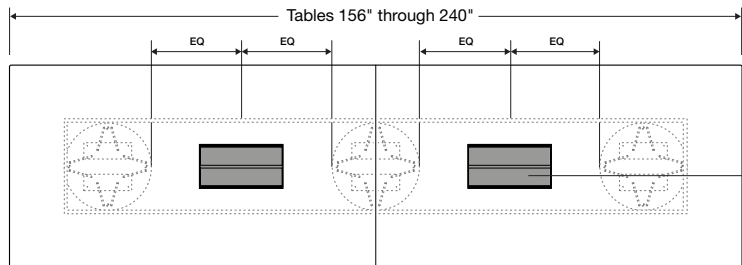
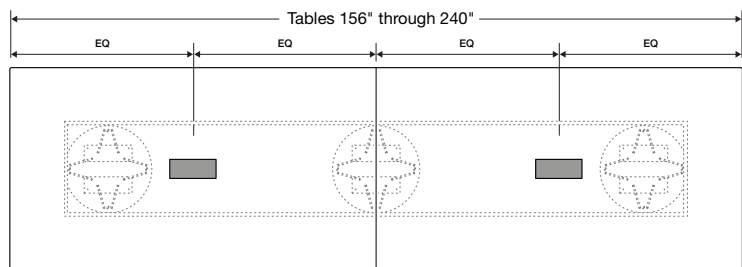
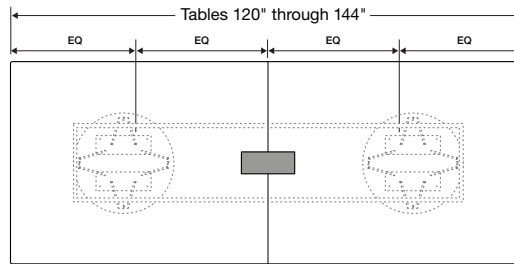

Single or Double Power Comm Trough

Coda-X

MhoB is the only recessed power unit that fits on tables 72" – 84"

GC Units, Boho, MhoB and single 7" and 12" Power Comm troughs must be oriented this way between bases on tables 90" and 96" wide.



GC Units, Boho, MhoB and single 7" and 12" Power Comm troughs can be oriented either way between bases on tables 108" or greater.

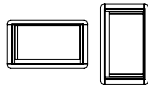

GC Units, Boho, MhoB power must be oriented this way over center plinth.

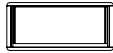

Recessed console: All single Power Comm troughs greater than 12" and double power comm troughs must be oriented in this direction on tables 108" greater and width must fit between bases.

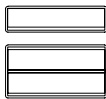

Troughs cannot extend the width of the Coda-X base tables due to base interference.

Tables 72" – 120" have no center plinth and require additional wire management options such as Cable Drop.

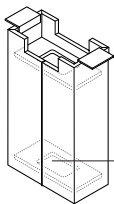

Bottom cutout is 7" x 4"

Tables 132" – 240" have a center plinth base that allows for wire management.

Tuohy recommendations for recessed consoles for all shapes

Recessed power can be placed over center base but cannot overlap base panels or mounting plates. Base is notched to allow power to run over depth of base (see base detail).

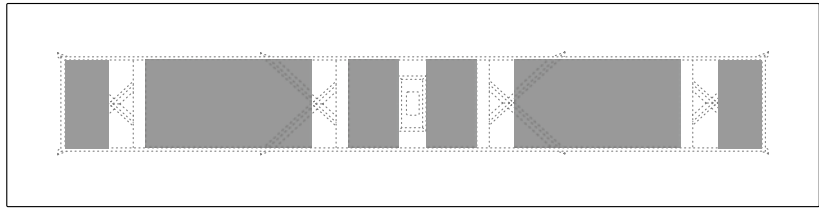

Recessed power can be placed in space between bases within base frame. Cannot overlap base frame.

Power in this section must not interfere into leg. Avoid power too close to center X-bases due to leg interference.

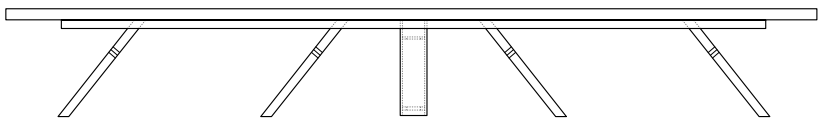

Tables 72" through 84" MhoB or Perimeter Power recommended

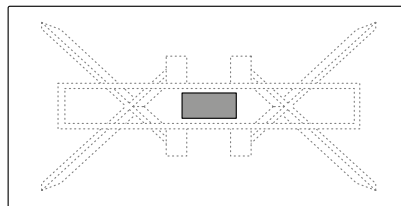

Tables 90" through 96"

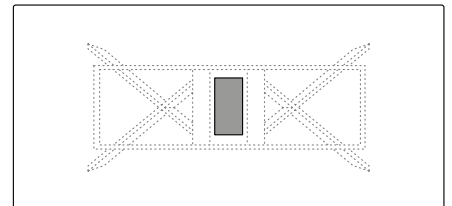

Tables 108" through 180"

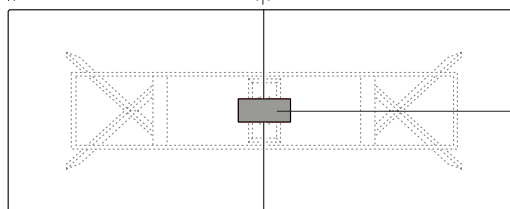

Standard Plinth base allows for single trough only
Center bases start at 132"

Tables 192" through 240"

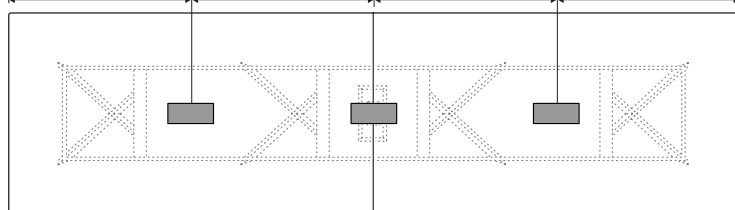

Tables 192" through 240"

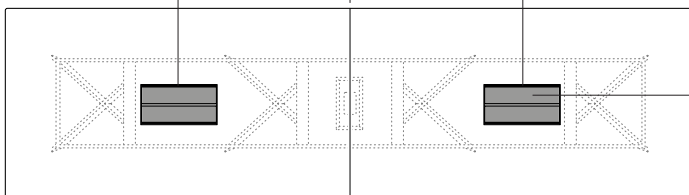

Single or Double Power Comm Trough between bases

Cylinder

GC Interact, MhoB, Boho and 7" single or double troughs can be orientated either direction.

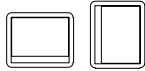

All single troughs 12" or greater, all double troughs and GC Interface units must be orientated this direction

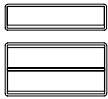

Troughs cannot extend with width of the cylinder base tables due to base interference.

All Tables allow wire management through cylinder bases if table has power.

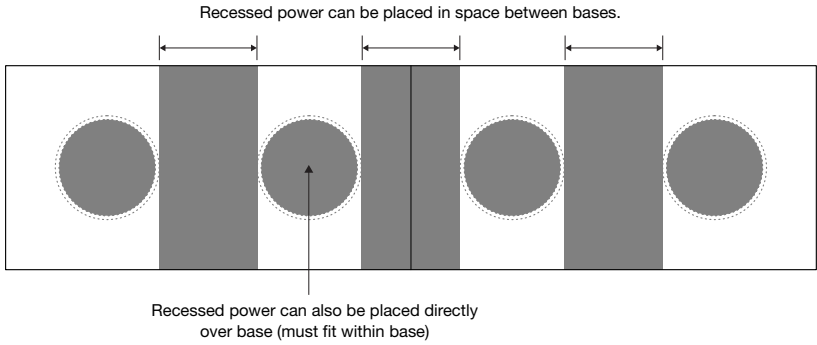

Tuohy recommendations for recessed consoles for all shapes

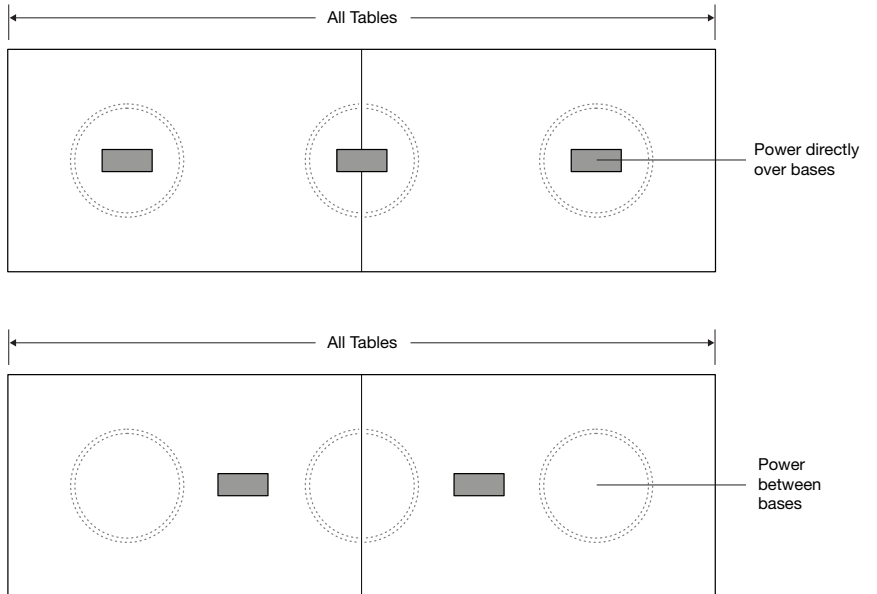

Plinth

All single & double troughs 18" or greater, and the GC Interface units must be oriented this direction.

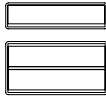

7" & 12" troughs single or double, Boho, MhoB and GC Interact units can be oriented either direction

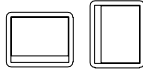

All tables allow for wire management through Plinth bases.

Tuohy recommendations for recessed consoles for all shapes

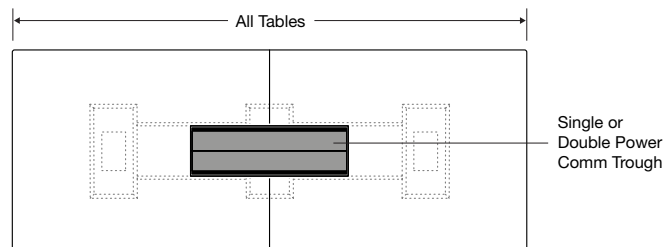
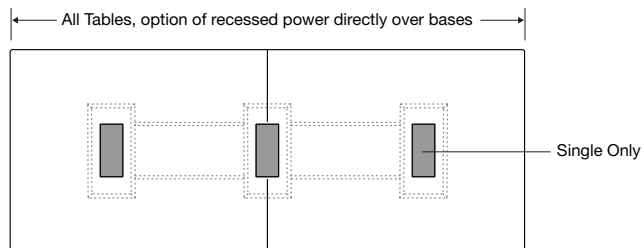
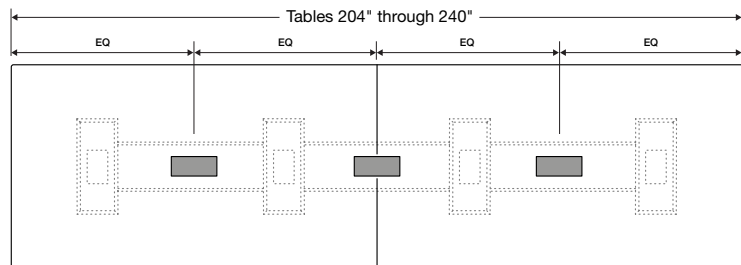
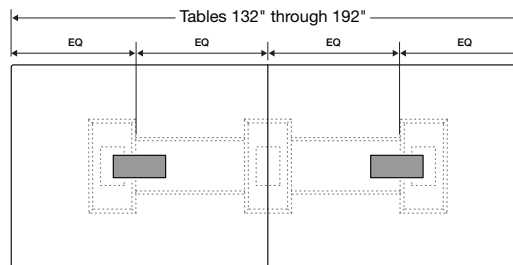
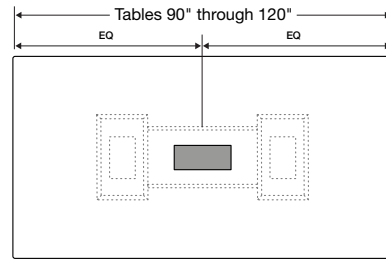
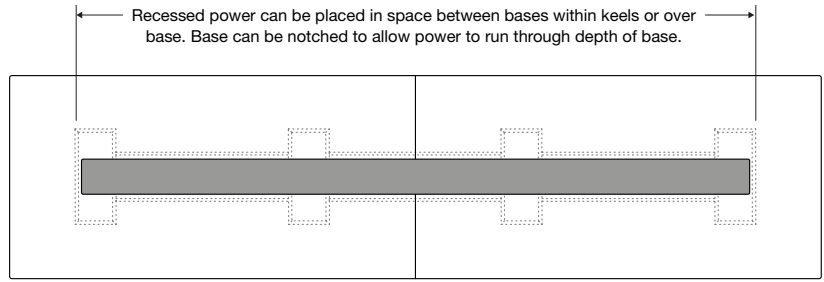

Ryvit & Spyda

7", 12"w & 18"w single & double troughs, GC Interface & Interact, Boho & MhoB can be oriented either direction.

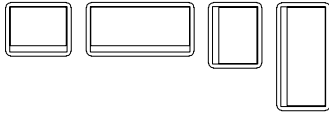

All single & double troughs 24" or greater must be oriented this direction.

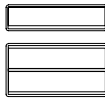

All tables require additional wire management options such as Cable Drop.

Recessed power can be placed in space between base plates.
Cannot overlap base plates.

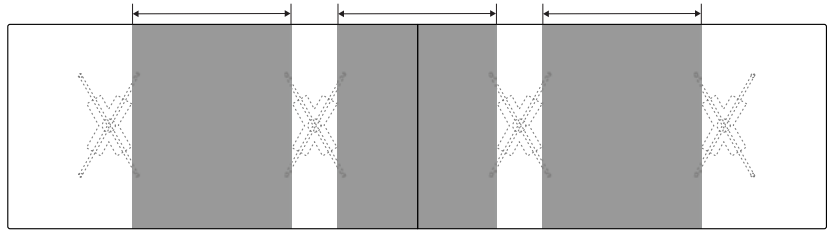

Recessed power can be placed in space between base plates.
Cannot overlap base plates.

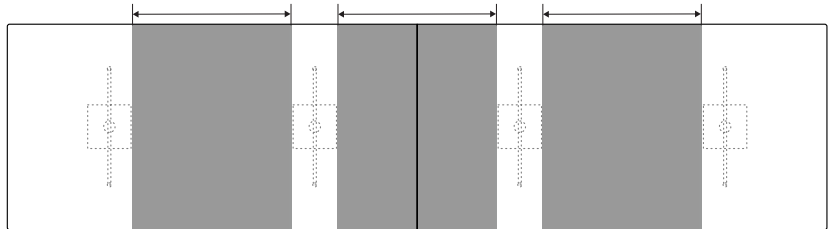

Recessed power can be placed in space between base plates.
Cannot overlap base plates.

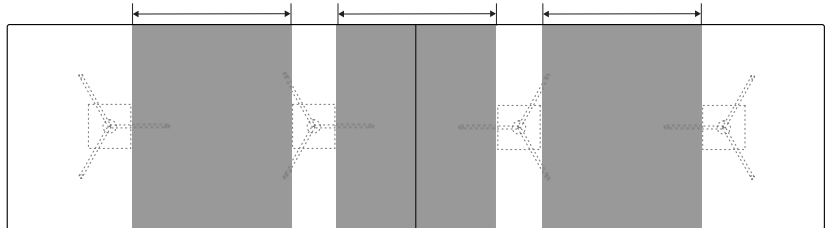

Recessed power can be placed in space between base plates.
Cannot overlap base plates.

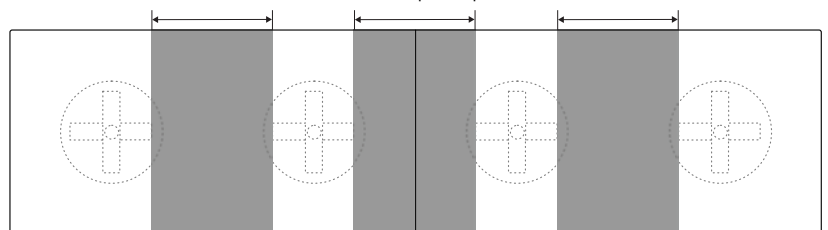

Tuohy recommends placing recessed power equally spaced between bases for all shapes and Spyda/Ryvit bases.

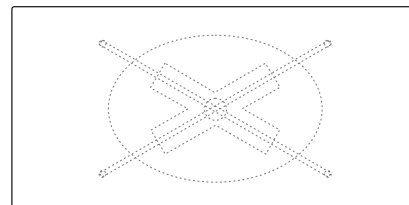
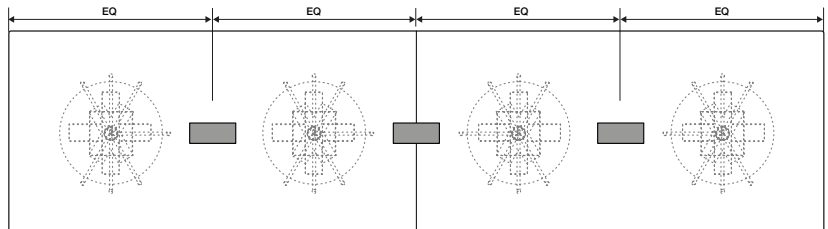

Small tables with a center base do not allow center power. Tuohy recommends perimeter power options.

Uffizi-Loop

All 7" & 12"w single & double troughs, GC Interface & Interact, Boho & MhoB units can be oriented either direction.

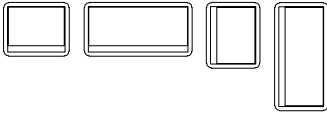

All single & double troughs 18" or greater must be oriented this direction.

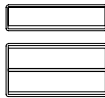

Tables 72" - 120" have no center plinth and require additional wire management options such as Cable Drop.

Tables 132" - 240" have a center plinth base that allows for wire management.

Tuohy recommendations for recessed consoles for all shapes

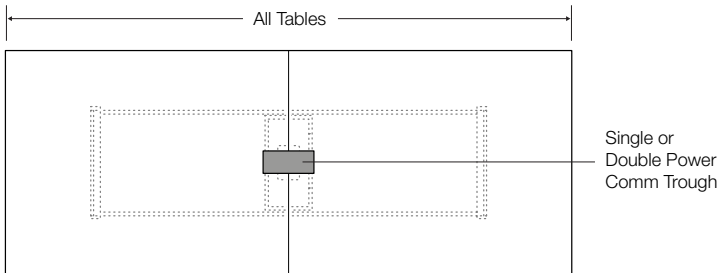
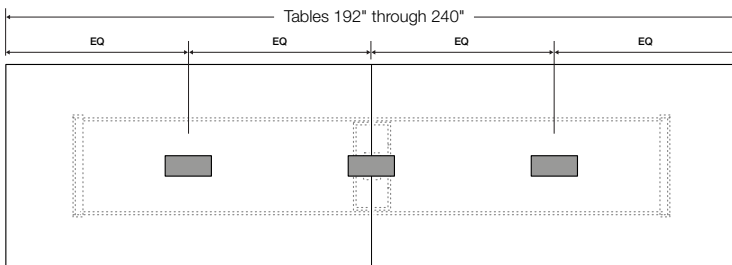
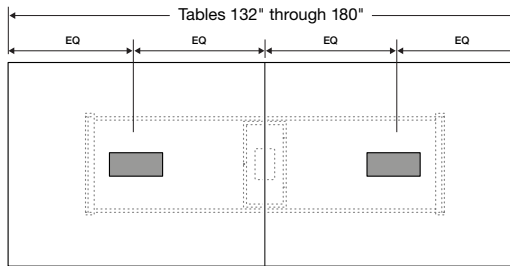
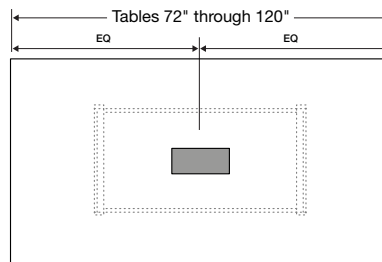
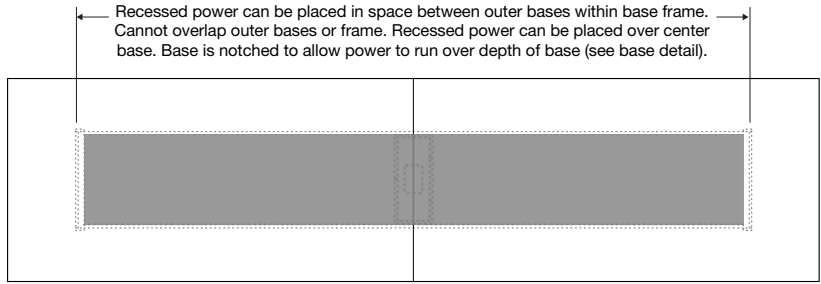

Zi-A & Zi-D

All 7" & 12"w single & double troughs, GC Interact, Boho, MhoB can be oriented either direction.



All single & double troughs 18" w or greater, GC Interface units must be oriented this direction.



All tables allow for wire management through bases.

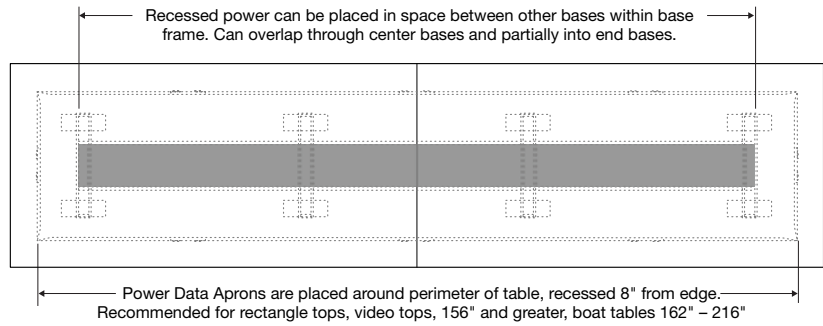

Tuohy recommendations for recessed consoles for all shapes

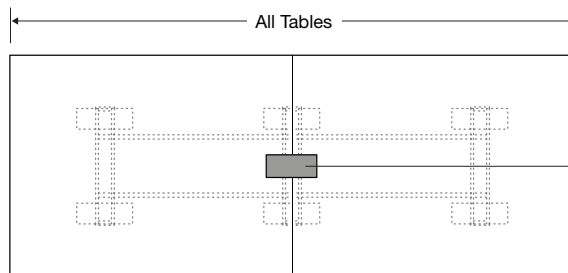
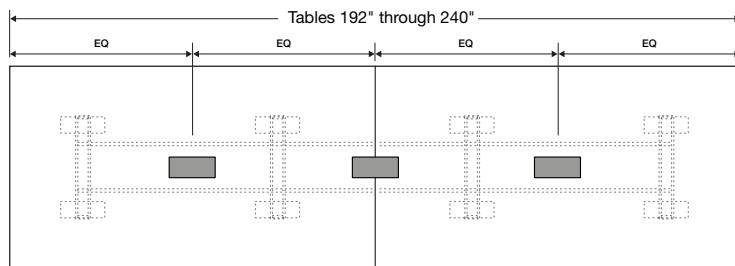
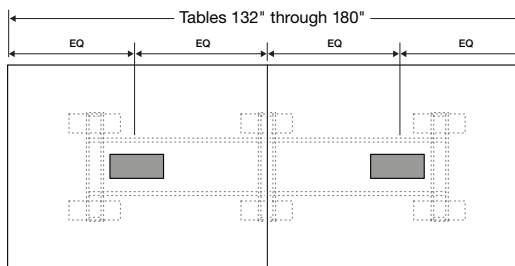
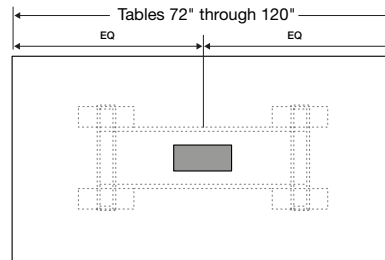

Power Routing Overview

In – Through – Out

Getting power from the floor, into the table, through the table, and out for users to access in a clean way is easy with the many base options that Univers offers.

Out
Access for users on or under the top

Through
Wire management & cord routing for a clean aesthetic

In
Power accessed from the floor via plug or hardwire options

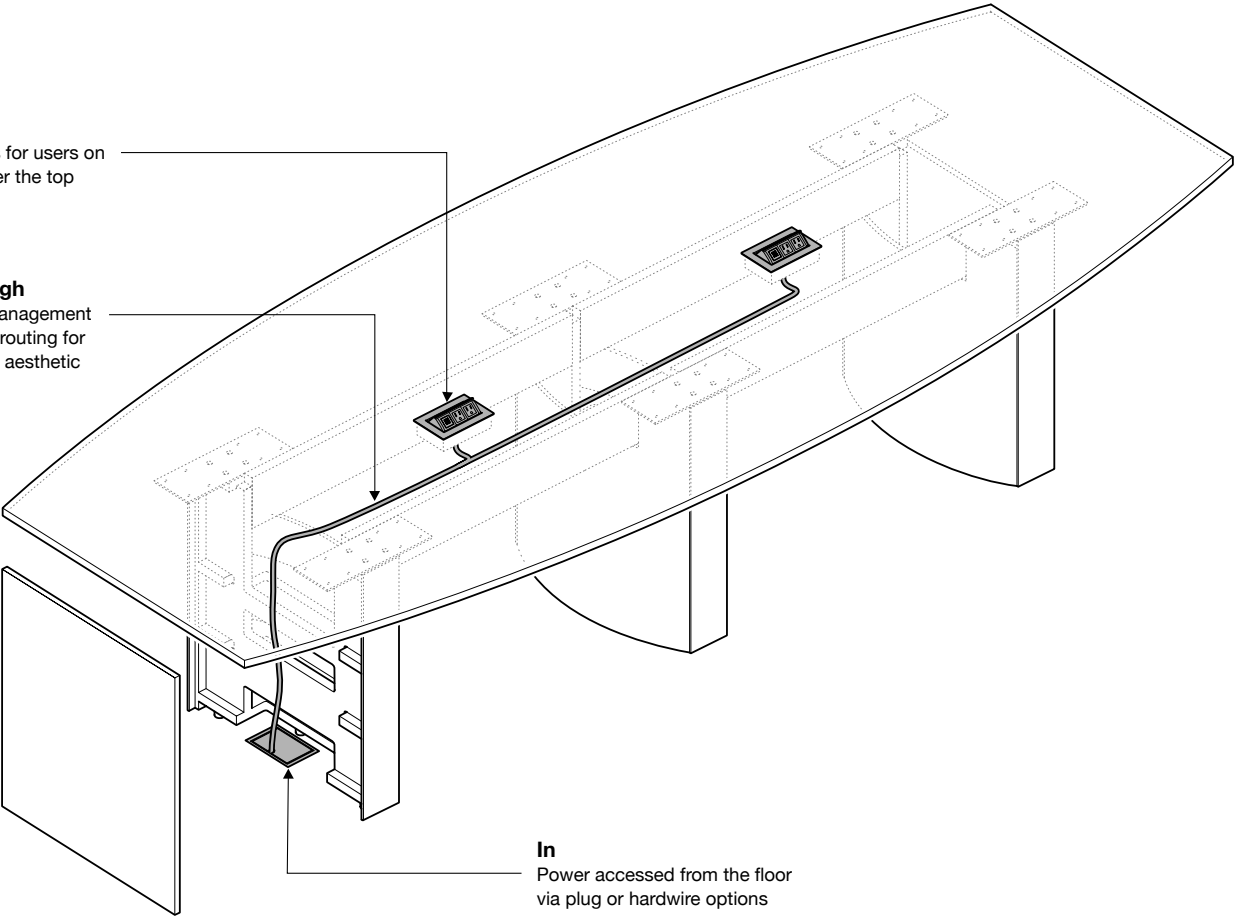

Power Routing: In

Several Unvers base options have power routing capabilities created by removable access doors and a wire routing cavity.

Plinth Base

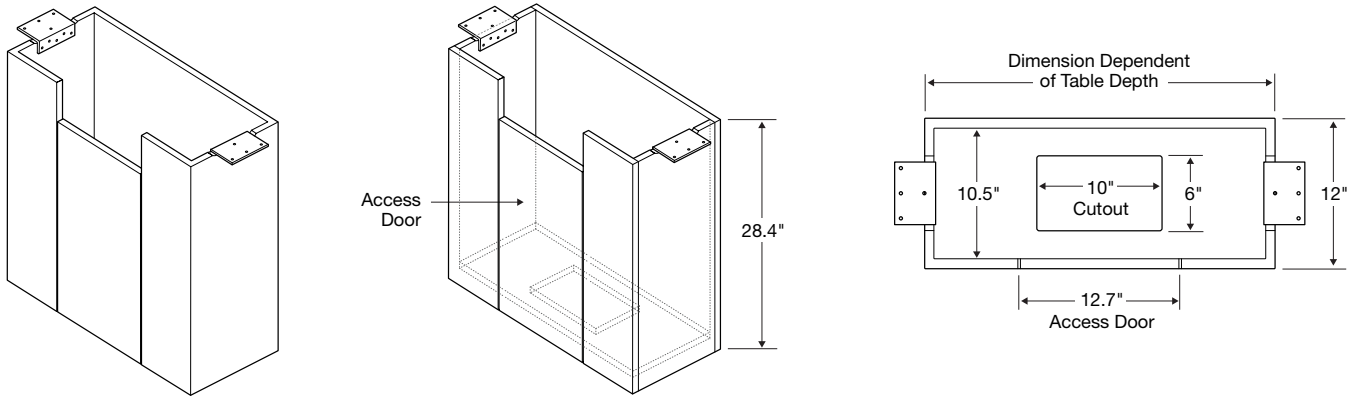

Zi-A Base

Details for bases 24" and over

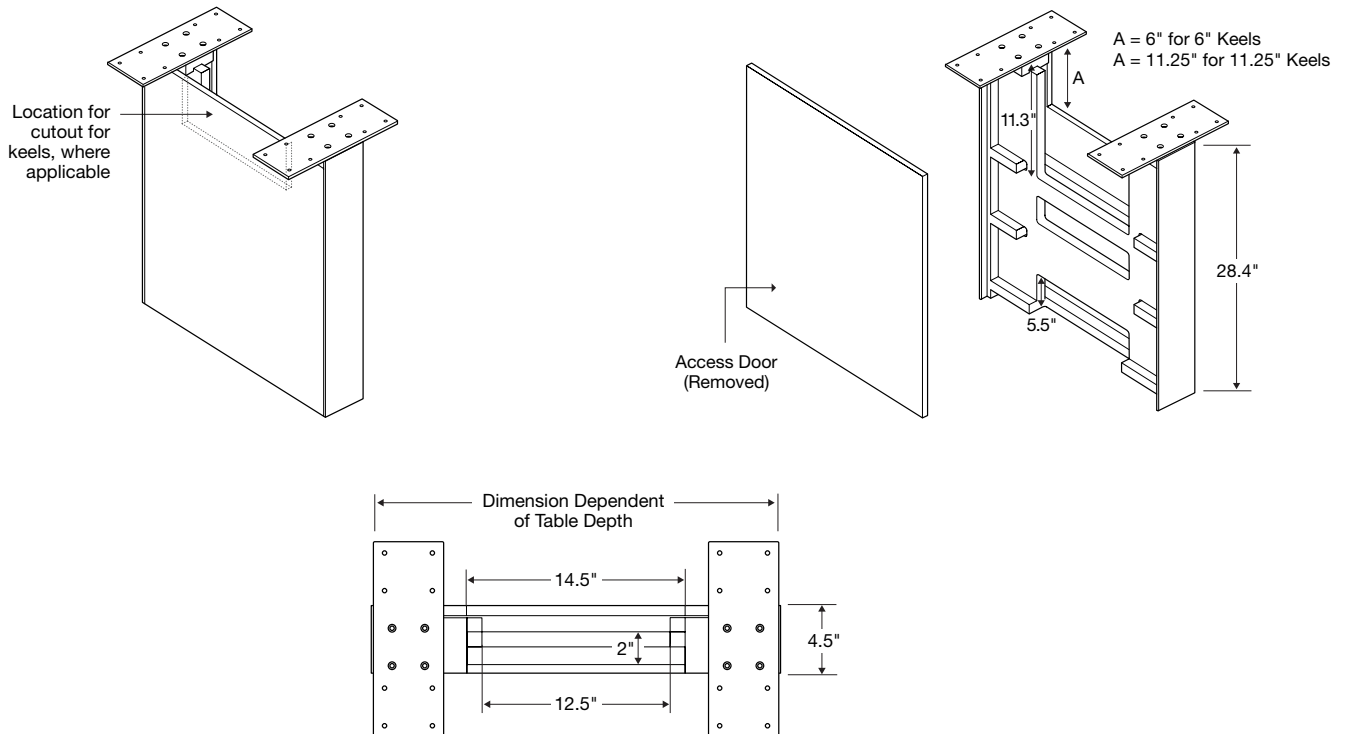

Power Routing: In

Zi-D Base – End Base

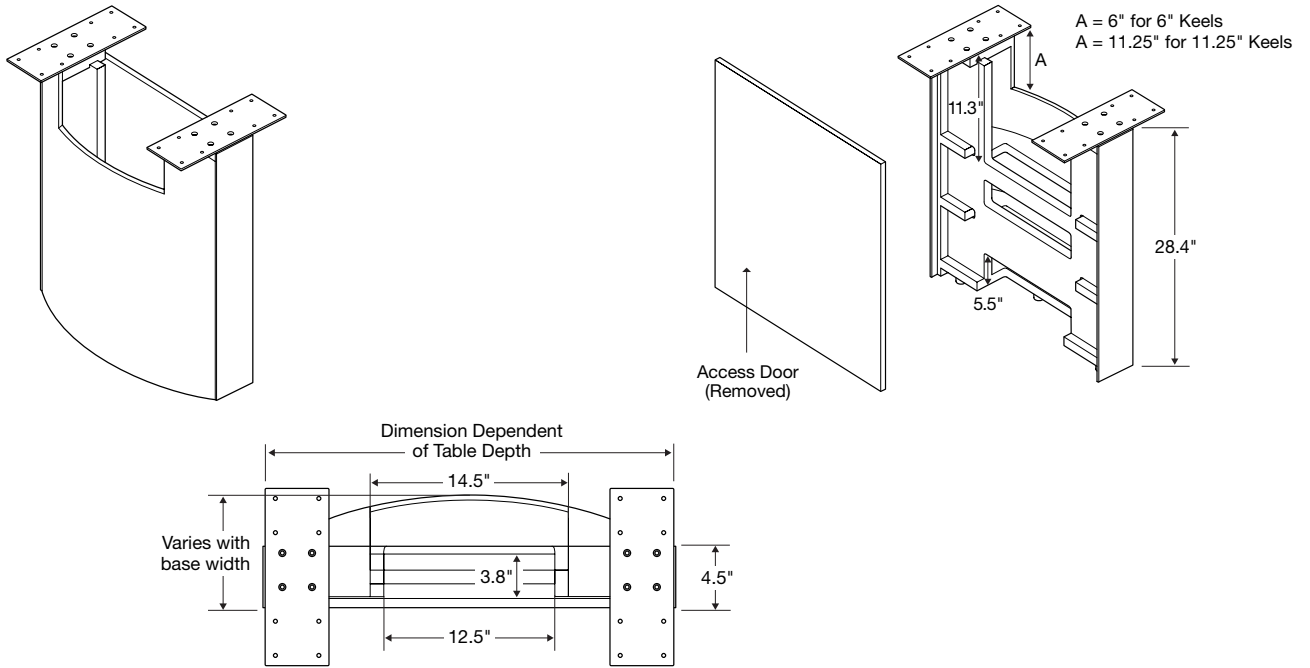

Zi-D Base – Center Base

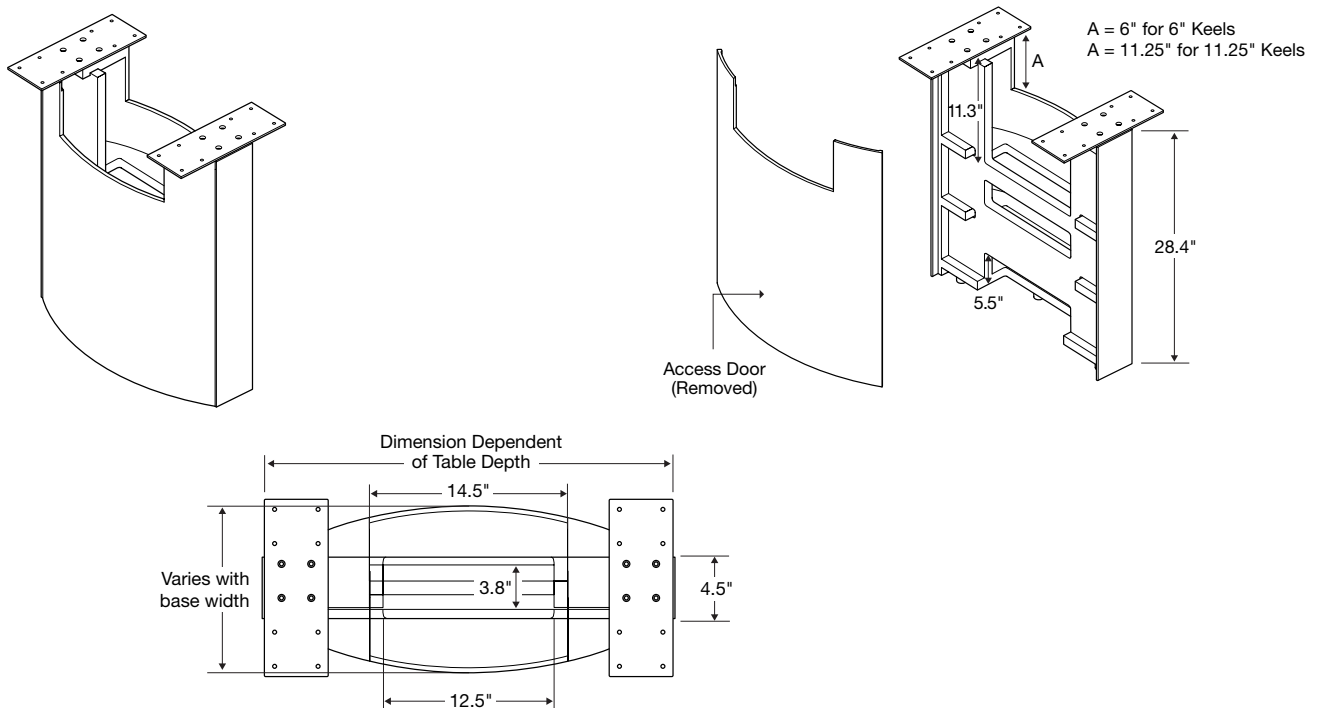

Power Routing: In

For bases that are more decorative, such as the Coda-V base, the Cavo Cable Drop can be added to help provide wire management from the floor to the table in a clean manner. Cords pass through the hollow sock that is offered in three color options.

After the sock is wrapped around the top ring, the ring is attached to the underside of the surface with screws. A gap between the top of the sock and the underside of the surface will remain to allow for cords to pass through.

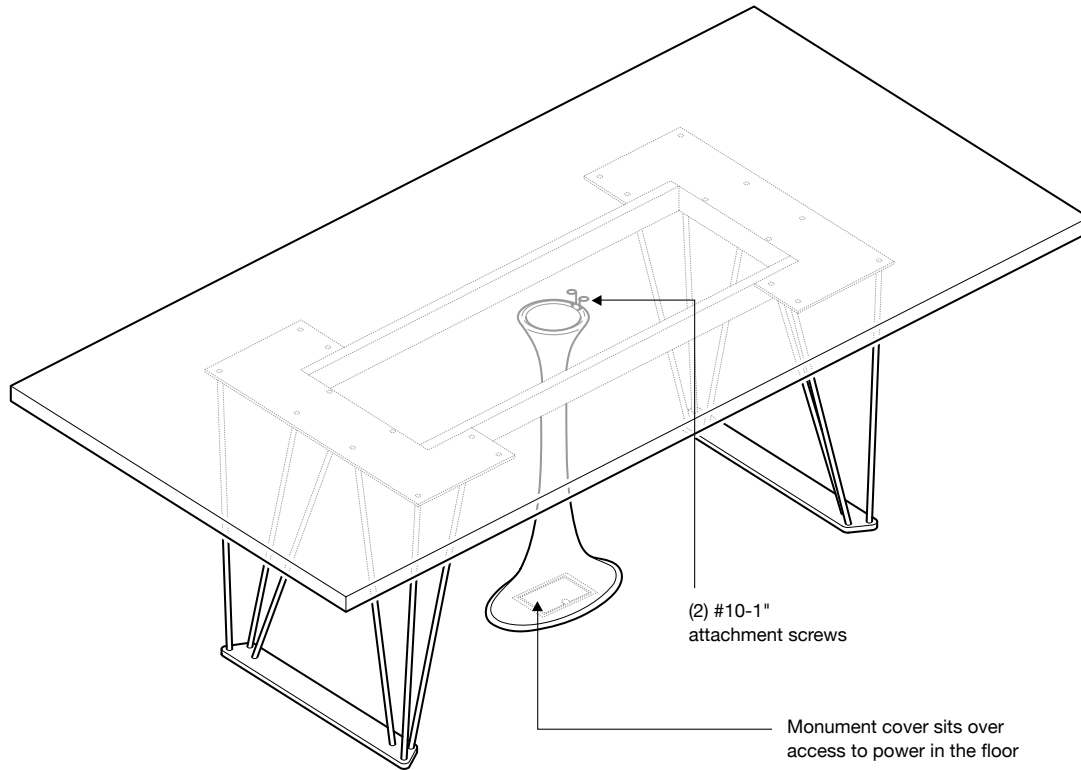

Monument Cover Details

The monument cover fits over the power monument in the floor to allow for cords to route from the floor to the underside of the table in a clean manner.

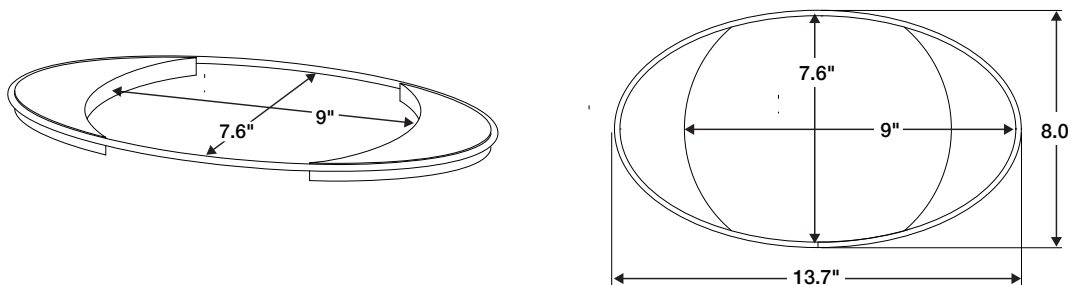

Power Routing: Out

Surface power and data options are mounted to or accessed through the top of the table surface, allowing for easy user access.

Surface Power Units

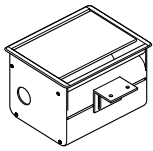

Power-Comm Troughs (Single)

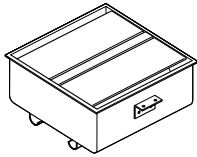

Power-Comm Troughs (Dual)

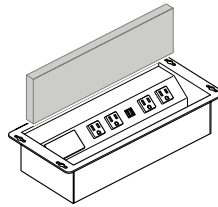

Power-Comm Recessed Consoles (GC & GCS)

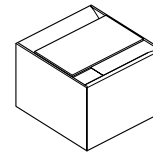

Boho

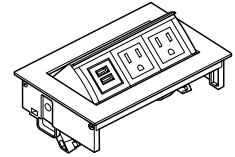

MhoB

Power Comm Trough

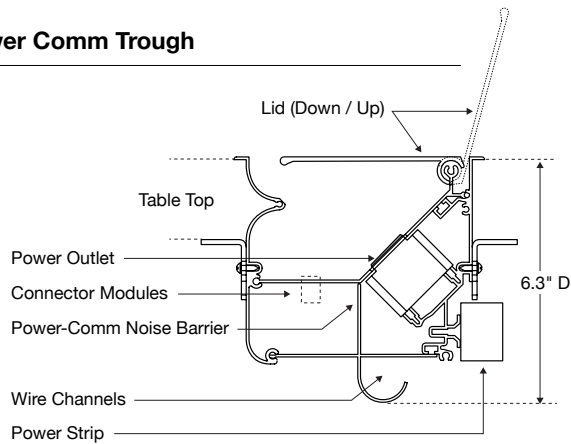

Boho

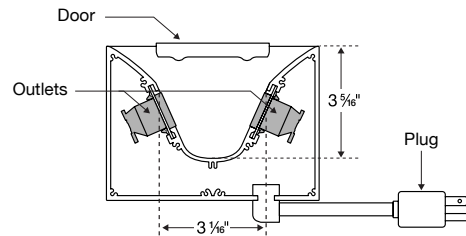

Power Comm Recessed Console (GC & GCS)

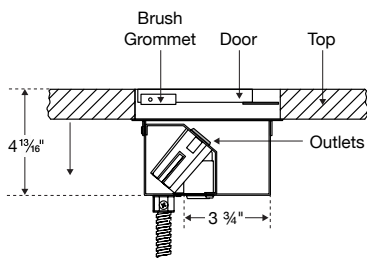

Perimeter Power & Data Units

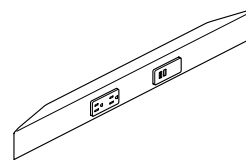

Power-Data Aprons

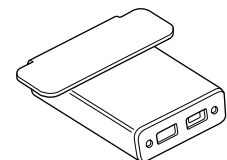

Garcia 2-Trac