

PRICING & SPECIFICATION GUIDE
Axis Collection

June 1, 2023

TUOHY



Casegoods: **Axis**

- Mobile Tables AAX3
- Mobile Pedestals AAX4
- Panel System AAX6
- Power Infeeds AAX7
- End Mount Pole AAX7
- Data Connectors AAX7
- Divider Screens AAX8
 - Clear Glass AAX8
 - Low-Iron Glass AAX9
 - Grey Glass AAX10
 - Acid Etched on Clear Glass AAX11
 - Acid-Etched on Low-Iron Glass AAX12
 - Acoustic Panels AAX13

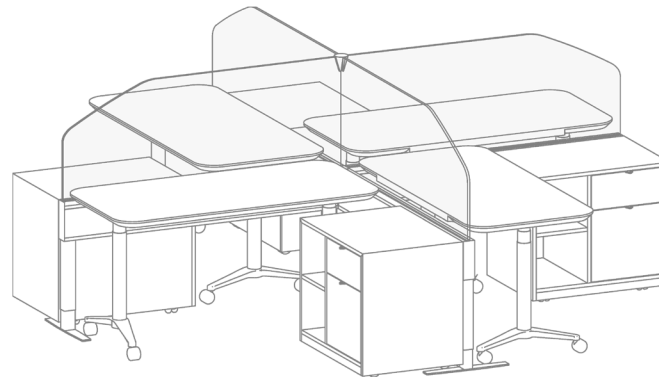
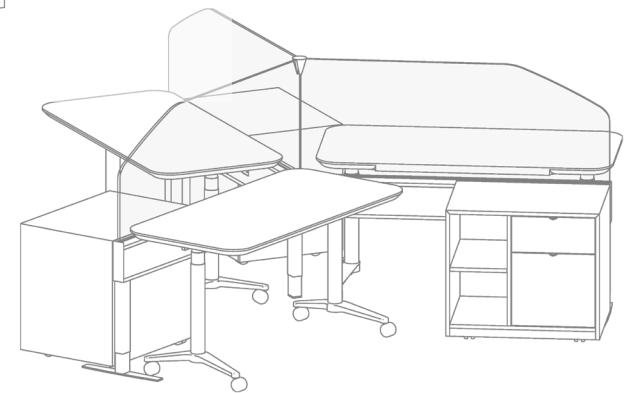
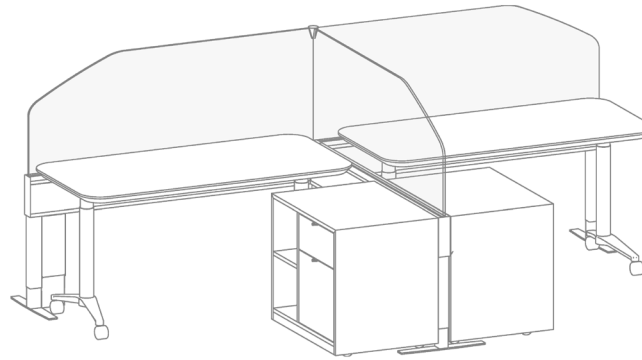

Mobile Tables
Height Adjustable

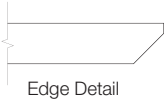
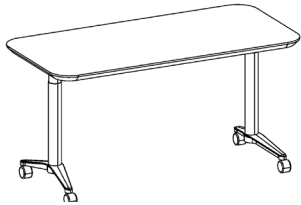

Description	Prod. No. Prefix	Top Material (specify by code)			Wire Management Basket (Optional)
		HPL	Wood 1	Wood 2	
Adj Ht Mobile Table, 26.5-52.5h		...HPL	...W1	...W2	WMB
• 60 x 30 Table	AXA6030...	5287	5566	5956	404
72 x 30 Table	AXA7230...	5428	5714	6114	404

To Include Wire Management Basket Append **WMB** to End of Product Number. Add Cost to List Price.

> To Order:

For product number, append Top Material Code to Prod. No. Prefix.
For list price, read across from Prefix Code and down from Top Material Code; price includes leg and foot finish option.
Ex. For 60x30 Table with Wood1 Top, product number is AXA6030W1; list price is \$5566.

! Notes:

HPL: Formica 949-58 White with PVC Edge.

Wood1: All TUOHY Wood1 offerings.

Wood2: All TUOHY Wood2 offerings.

Tops have Bevel Edge Detail.

Worksurfaces are undersized 1-in on all sides to allow for pinch point clearances.

All tables include Linak USB Charger with One USB Type A 7.5W, Two USB Type-C 50W. White Finish.

Linak USB Charger to be field mounted to top or bottom of worksurface. Plugs directly to control box.
Optional Wire Management Basket is finished MRB Resin Black; includes 6-outlet surge protector.

+ Options

Specify metal leg and foot finish: MRB Resin Black, MRW Resin White, MRSA Resin Satin Aluminum.

To Add Optional Baltic Birch Top Edgeband specify Option BB (no price change). Only available on Wood Tops.

The BB Edge will receive the same stain as the veneer top which may result in a dramatic color contrast.

Desks are electric powered. See below for battery power for desk.

Optional Wire Management Basket

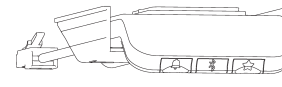
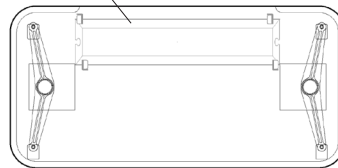

Adjustable Height Table Controller



Baltic Birch Edgeband

Battery Power Options

Battery Kit	ELBK	975
Charging Kit	ELCK	200

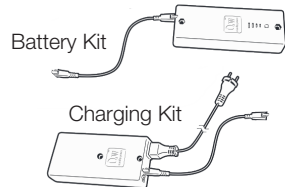

! Notes:

Battery Kit includes Battery and 8-in cable to plug into desk control box.

Charging Kit includes 8-in cable, charger, and power cable.

Wire Management Basket is recommended.

Specify: Product Number & Qty
Tagging
Wood Finish

• Denotes Item is illustrated.
- Includes locks.

Prices listed in Wood1 Finishes.

Mobile Pedestals, 26.75h
Mitered Construction

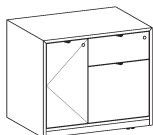
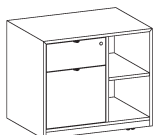
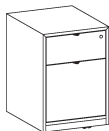
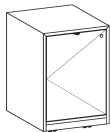

Pull Detail

Description	18d		21d	
	Prod. No.	List \$	Prod. No.	List \$
• Cabinet 18w LH	AXBCL18	2759	AXCCL18	2902
Cabinet 18w RH	AXBCR18	2759	AXCCR18	2902
Cabinet 20w LH	AXBCL20	2809	AXCCL20	3231
Cabinet 20w RH	AXBCR20	2809	AXCCR20	3231
Cabinet 30w DBL	AXBC30	3037	AXCC30	3493
Cabinet 36w DBL	AXBC36	3231	AXCC36	3715
• Box/File 18w	AXBR18	3128	AXCR18	3309
Box/File 20w	AXBR20	3166	AXCR20	3641
• Box/File18 - Open12 30w	AXBRA30	3503	AXCRA30	4028
Box/File18 - Open18 36w	AXBRA36	3734	AXCRA36	4294
Open12 - Box/File18 30w	AXBAR30	3503	AXCAR30	4028
Open18 - Box/File18 36w	AXBAR36	3734	AXCAR36	4294
Box/File18 - RH Cabinet12 30w	AXBRC30	3658	AXCRC30	4207
Box/File18 - RH Cabinet18 36w	AXBRC36	3825	AXCRC36	4399
• LH Cabinet12 - Box/File18 30w	AXBCR30	3658	AXCCR30	4207
LH Cabinet18 - Box/File18 36w	AXBCR36	3825	AXCCR36	4399

! Notes:

Mobile Pedestals are finished all sides
Mitered Construction

+ Options

Specify Pull Finish: MRB Resin Black, MRW Resin White, MRSA Resin Satin Aluminum
Locks are included standard. For No Locks Specify NL.

To add optional Baltic Birch Top Edgeband specify Option BB, No Price Change.

The BB Edge will receive the same stain as the veneer case which may result in a dramatic color contrast.

Specify: Product Number & Qty
Tagging
Wood Finish

• Denotes Item is illustrated.
- Includes locks.

Prices listed in Wood1 Finishes.

Mobile Pedestals, 26.75h
Butt-Joint Construction

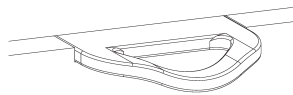
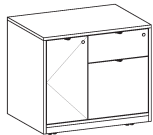
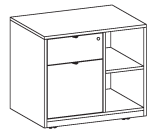
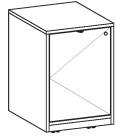

Pull Detail

Description	18d		21d	
	Prod. No.	List \$	Prod. No.	List \$
• Cabinet 18w LH	AXDCL18	1986	AXECL18	2089
Cabinet 18w RH	AXDCR18	1986	AXECL18	2089
Cabinet 20w LH	AXDCL20	2023	AXECL20	2326
Cabinet 20w RH	AXDCR20	2023	AXECL20	2326
Cabinet 30w DBL	AXDC30	2187	AXEC30	2515
Cabinet 36w DBL	AXDC36	2326	AXEC36	2675
• Box/File 18w	AXDR18	2252	AXER18	2383
Box/File 20w	AXDR20	2280	AXER20	2622
• Box/File18 - Open12 30w	AXDRA30	2522	AXERA30	2900
Box/File18 - Open18 36w	AXDRA36	2689	AXERA36	3092
Open12 - Box/File18 30w	AXDAR30	2522	AXEAR30	2900
Open18 - Box/File18 36w	AXDAR36	2689	AXEAR36	3092
Box/File18 - RH Cabinet12 30w	AXDRC30	2634	AXERC30	3029
Box/File18 - RH Cabinet18 36w	AXDRC36	2754	AXERC36	3167
• LH Cabinet12 - Box/File18 30w	AXDCR30	2561	AXECL30	3029
LH Cabinet18 - Box/File18 36w	AXDCR36	2677	AXECL36	3167

! Notes:

Mobile Pedestals are finished all sides
Butt-Joint Construction

+ Options

Specify Pull Finish: MRB Resin Black, MRW Resin White, MRSA Resin Satin Aluminum
Locks are included standard. For No Locks Specify NL.

To add optional Baltic Birch Top Edgeband specify Option BB, No Price Change.

The BB Edge will receive the same stain as the veneer case which may result in a dramatic color contrast.

Specify: Product Number & Qty
Tagging
Wood Finish

- Denotes Item is illustrated.
- Includes locks.

Prices listed in Wood1 Finishes.

Panel System, 26.8h

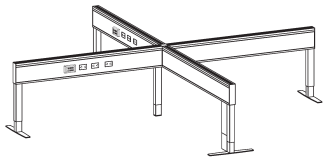
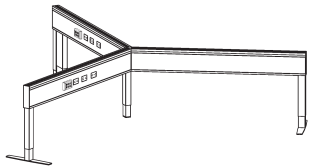
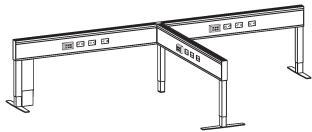

Description	Product No.	List \$	+ Cover Panel (Optional)	
			Wood1	Wood2
T-Station (2 Person)			W1	W2
60 x 60 x 60	AXFA	8503	2143	2250
• 60 x 60 x 72	AXFB	8750	2566	2695
72 x 72 x 60	AXFC	8919	2566	2695
72 x 72 x 72	AXFD	9121	2329	2446
Y-Station (3 Person)			W1	W2
• 60 x 60 x 60	AXGA	8227	2143	2250
72 x 72 x 72	AXGB	8844	2329	2446
X-Station (4 Person)			W1	W2
• 60 x 60 x 60 x 60	AXHA	10626	2486	2611
60 x 72 x 60 x 72	AXHB	11081	3306	3471
72 x 72 x 72 x 72	AXHC	11467	3069	3223



For Optional Cover Panel, append the Cover Panel Code to the Prod. No. add Cost to List Price.

! Notes:

- Each Powered Beam includes 15 Amp Outlets, (2) Circuit 1 Outlets, and (1) Circuit 4 Outlets.
- Each Powered Beam includes Single Gang Plate Adapter and 6 Port Data Gang Plate.
- Data Connectors and/or Hole Blanks need to be ordered separately.
- Each Station includes Infeed Box.
- Specify Divider Screens from listing on page AAX8-AAX13

+ Options:

- Specify Panel System Finish: Black (~MRB). Power Receptacles are Black.
- Satin White (~MRW). Power Receptacles are White
- Metallic Silver (~MRSA). Power Receptacles are Black.
- For Chicago Code append CC to end of Product Number; No price change. See Following Notes Specific to Chicago Code:
 - Junction box allows for two Single Gang Outlets per side.
 - Junction boxes do not include electrical connectors.
 - Boxes are UL Listed.
 - Boxes have standard 0.875-in knockouts for electrical connectors.
 - Junction boxes can be used with either 15 Amp or 20 Amp Single Gang Outlets.
 - Standard NEMA outlets.
 - Decorative outlets cannot be used.

Specify: Product Number & Qty
 Tagging
 Wood Finish

- Denotes Item is illustrated.
- Includes locks.

Prices listed in Wood1 Finishes.

Power Infeeds

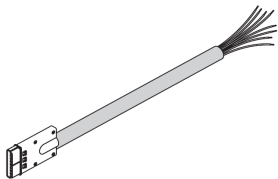

Description	Product No.	List \$
Power Infeeds - 8 Wire 4 Circuit Hardwire		
72-in Infeed	AXJ-72	494
72-in New York Infeed	AXJ-NY	983
144-in Ceiling Infeed*	AXJ-144	579

! Notes:
 Side-mount Base In-feeds provide interface with building power at the end of the power units and mounts to the powerway at the jumper location.
 Each Base In-feed is 6-in length, encased in "Liquid Tight".
 New York City Code requires the use of a special Base Feed with an In-line Junction Box.
 The Power Infeeds are Not available in a Soft Plug option.
 *Ceiling Infeed Option requires a separately specified End Mount Pole.

End Mount Pole



End Mount Pole	AXKA	1627
----------------	------	------

! Notes:
 End Mount Poles are used for concealing In-Feeds or Data Cables from a Max 11-Ft 6-in standard suspended ceiling.
 Order Ceiling Infeed Separately.
 Poles Must be attached to ceiling grid at time of installation. Beam will not support End Mount Pole alone.
 Poles are Not UL listed for splicing cables in pole and are for Aesthetic Purposes Only.
 Specify End Mount Pole finish: Black (~MRB), Satin White (~MRW), Metallic Silver (~MRSA)

Data Connectors

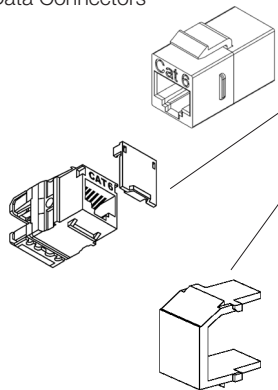

Data		
Cat 6 Inline Coupler, Black	AXLA	21
Cat 6 MT-Series Keystone, Black	AXLB	21
Blank Keystone Module (10-Pack), Black	AXLC	15

! Notes:
 Each Data Plate in the Panel System Includes 6 Ports.

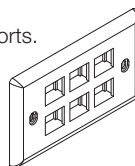

Specify: Product Number & Qty
 Tagging
 Wood Finish

- Denotes Item is illustrated.
- Includes locks.

Prices listed in Wood1 Finishes.

Divider Screens

Clear Glass

Divider Screen only.
See pg AX6 for Cooresponding
Panel System.

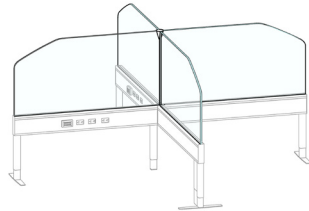
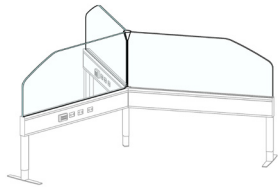

Description	Product No.	List \$	Product No.	List \$	Product No.	List \$
Glass Divider for T-Station (2 Person)	16"h (42" Installed)		28"h (54" Installed)		34"h (60" Installed)	
60 x 60 x 60	• AXFAU16	1555	AXFAU28	3269	AXFAU34	3741
60 x 60 x 72	AXFBU16	1630	AXFBU28	3431	AXFBU34	3930
72 x 72 x 60	AXFCU16	1705	AXFCU28	3593	AXFCU34	4119
72 x 72 x 72	AXFDU16	1781	AXFDU28	3755	AXFDU34	4308
Glass Divider for Y-Station (3 Person)	16"h (42" Installed)		28"h (54" Installed)		34"h (60" Installed)	
60 x 60 x 60	AXGAU16	1555	• AXGAU28	3269	AXGAU34	3741
72 x 72 x 72	AXGDU16	1781	AXGDU28	3755	AXGDU34	4308
Glass Divider for X-Station (4 Person)	16"h (42" Installed)		28"h (54" Installed)		34"h (60" Installed)	
60 x 60 x 60 x 60	AXHAU16	1992	AXHAU28	4270	• AXHAU34	4899
60 x 72 x 60 x 72	AXHBU16	2143	AXHBU28	4593	AXHBU34	5277
72 x 72 x 72 x 72	AXHDU16	2293	AXHDU28	4917	AXHDU34	5655

! Notes:

Divider Screen Product Numbers include a complete set of divider screens for the panel system layout.

Ex. AXFAU16 Includes three 16h Clear Glass Divider Screens to be used with the item number AXFA panel sytem listed on page AAX6.

Specify: Product Number & Qty
Tagging
Wood Finish

- Denotes Item is illustrated.
- Includes locks.

Prices listed in Wood1 Finishes.

Divider Screens

Low-Iron Glass

Divider Screen only.
See pg AX6 for Cooresponding
Panel System.

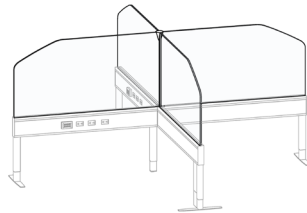
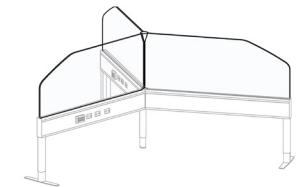

Description	Product No.	List \$	Product No.	List \$	Product No.	List \$
Glass Divider for T-Station (2 Person)	16"h (42" Installed)		28"h (54" Installed)		34"h (60" Installed)	
60 x 60 x 60	• AXFAV16	1716	AXFAV28	3579	AXFAV34	4118
60 x 60 x 72	AXFBV16	1802	AXFBV28	3761	AXFBV34	4331
72 x 72 x 60	AXFCV16	1887	AXFCV28	3943	AXFCV34	4545
72 x 72 x 72	AXFDV16	1973	AXFDV28	4125	AXFDV34	4758
Glass Divider for Y-Station (3 Person)	16"h (42" Installed)		28"h (54" Installed)		34"h (60" Installed)	
60 x 60 x 60	AXGAV16	1716	• AXGAV28	3579	AXGAV34	4118
72 x 72 x 72	AXGDV16	1973	AXGDV28	4125	AXGDV34	4758
Glass Divider for X-Station (4 Person)	16"h (42" Installed)		28"h (54" Installed)		34"h (60" Installed)	
60 x 60 x 60 x 60	AXHAV16	2207	AXHAV28	4684	• AXHAV34	5402
60 x 72 x 60 x 72	AXHBV16	2379	AXHBV28	5047	AXHBV34	5828
72 x 72 x 72 x 72	AXHDV16	2550	AXHDV28	5411	AXHDV34	6255

! Notes:

Divider Screen Product Numbers include a complete set of divider screens for the panel system layout.
Ex. AXFAV16 Includes three 16h Low-Iron Glass Divider Screens to be used with the item number AXFA panel sytem listed on page AAX6.

Specify: Product Number & Qty
Tagging
Wood Finish

- Denotes Item is illustrated.
- Includes locks.

Prices listed in Wood1 Finishes.

Divider Screens

Grey Glass

Divider Screen only.
See pg AX6 for Cooresponding
Panel System.

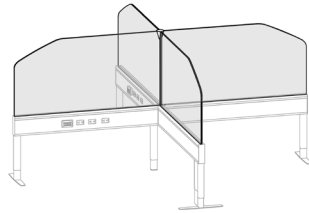
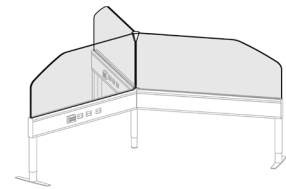
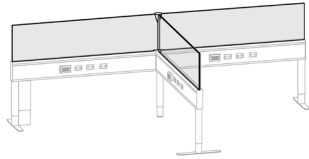

Description	Product No.	List \$	Product No.	List \$	Product No.	List \$
Glass Divider for T-Station (2 Person)						
			16"h (42" Installed)		28"h (54" Installed)	34"h (60" Installed)
60 x 60 x 60	• AXFAW16	2288	AXFAW28	4690	AXFAW34	5406
60 x 60 x 72	AXFBW16	2397	AXFBW28	4931	AXFBW34	5689
72 x 72 x 60	AXFCW16	2505	AXFCW28	5171	AXFCW34	5971
72 x 72 x 72	AXFDW16	2614	AXFDW28	5412	AXFDW34	6254
Glass Divider for Y-Station (3 Person)						
			16"h (42" Installed)		28"h (54" Installed)	34"h (60" Installed)
60 x 60 x 60	AXGAW16	2288	• AXGAW28	4690	AXGAW34	5406
72 x 72 x 72	AXGDW16	2614	AXGDW28	5412	AXGDW34	6254
Glass Divider for X-Station (4 Person)						
			16"h (42" Installed)		28"h (54" Installed)	34"h (60" Installed)
60 x 60 x 60 x 60	AXHAW16	2970	AXHAW28	6164	• AXHAW34	7119
60 x 72 x 60 x 72	AXHBW16	3187	AXHBW28	6646	AXHBW34	7684
72 x 72 x 72 x 72	AXHDW16	3404	AXHDW28	7128	AXHDW34	8250

! Notes:

Divider Screen Product Numbers include a complete set of divider screens for the panel system layout.
Ex. AXFAW16 Includes three 16h Grey Glass Divider Screens to be used with the item number AXFA panel sytem listed on page AAX6.

Specify: Product Number & Qty
Tagging
Wood Finish

- Denotes Item is illustrated.
- Includes locks.

Prices listed in Wood1 Finishes.

Divider Screens

Acid Etched on Clear Glass

Divider Screen only.

See pg AX6 for Cooresponding Panel System.

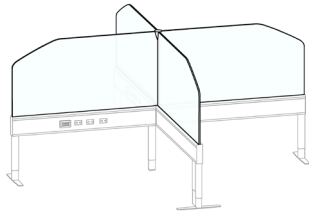
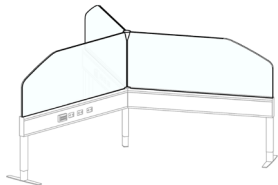
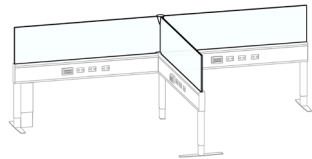

Description	Product No.	List \$	Product No.	List \$	Product No.	List \$
Glass Divider for T-Station (2 Person)	16"h (42" Installed)		28"h (54" Installed)		34"h (60" Installed)	
60 x 60 x 60	• AXFAX16	1988	AXFAX28	4104	AXFAX34	4755
60 x 60 x 72	AXFBX16	2092	AXFBX28	4320	AXFBX34	5009
72 x 72 x 60	AXFCX16	2195	AXFCX28	4535	AXFCX34	5263
72 x 72 x 72	AXFDX16	2298	AXFDX28	4751	AXFDX34	5518
Glass Divider for Y-Station (3 Person)	16"h (42" Installed)		28"h (54" Installed)		34"h (60" Installed)	
60 x 60 x 60	AXGAX16	1988	• AXGAX28	4104	AXGAX34	4755
72 x 72 x 72	AXGDX16	2298	AXGDX28	4751	AXGDX34	5518
Glass Divider for X-Station (4 Person)	16"h (42" Installed)		28"h (54" Installed)		34"h (60" Installed)	
60 x 60 x 60 x 60	AXHAX16	2570	AXHAX28	5383	• AXHAX34	6251
60 x 72 x 60 x 72	AXHBX16	2777	AXHBX28	5814	AXHBX34	6760
72 x 72 x 72 x 72	AXHDX16	2983	AXHDX28	6246	AXHDX34	7268

! Notes:

Divider Screen Product Numbers include a complete set of divider screens for the panel system layout.

Ex. AXFAX16 Includes three 16h Acid Etched on Clear Glass Divider Screens to be used with the item number AXFA panel sytem listed on page AAX6.

Specify: Product Number & Qty
Tagging
Wood Finish

- Denotes Item is illustrated.
- Includes locks.

Prices listed in Wood1 Finishes.

Divider Screens

Acid Etched on Low-Iron Glass

Divider Screen only.
See pg AX6 for Cooresponding Panel System.

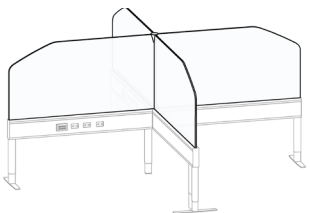
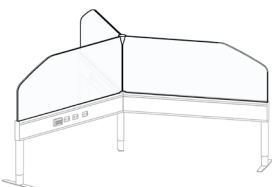

Description	Product No.	List \$	Product No.	List \$	Product No.	List \$
Glass Divider for T-Station (2 Person)	16"h (42" Installed)		28"h (54" Installed)		34"h (60" Installed)	
60 x 60 x 60	• AXFAY16	2280	AXFAY28	4665	AXFAY34	5436
60 x 60 x 72	AXFBY16	2402	AXFBY28	4917	AXFBY34	5734
72 x 72 x 60	AXFCY16	2524	AXFCY28	5168	AXFCY34	6032
72 x 72 x 72	AXFDY16	2646	AXFDY28	5420	AXFDY34	6330
Glass Divider for Y-Station (3 Person)	16"h (42" Installed)		28"h (54" Installed)		34"h (60" Installed)	
60 x 60 x 60	AXGAY16	2280	• AXGAY28	4665	AXGAY34	5436
72 x 72 x 72	AXGDY16	2646	AXGDY28	5420	AXGDY34	6330
Glass Divider for X-Station (4 Person)	16"h (42" Installed)		28"h (54" Installed)		34"h (60" Installed)	
60 x 60 x 60 x 60	AXHAY16	2959	AXHAY28	6131	• AXHAY34	7159
60 x 72 x 60 x 72	AXHBY16	3203	AXHBY28	6634	AXHBY34	7755
72 x 72 x 72 x 72	AXHDY16	3447	AXHDY28	7138	AXHDY34	8351

! Notes:

Divider Screen Product Numbers include a complete set of divider screens for the panel system layout.
Ex. AXFAY16 Includes three 16h Acid Etched on Low-Iron Glass Divider Screens to be used with the item number AXFA panel sytem listed on page AAX6.

Specify: Product Number & Qty
Tagging
Wood Finish

- Denotes Item is illustrated.
- Includes locks.

Prices listed in Wood1 Finishes.

Divider Screens

Acoustic

Divider Screen only.
See pg AX6 for Cooresponding
Panel System.

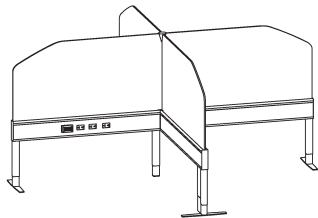
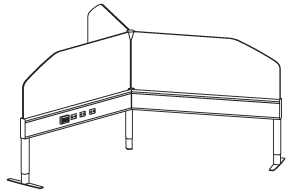
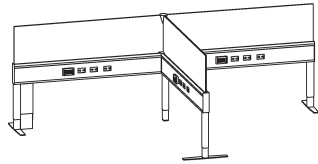

Description	Product No.	List \$	Product No.	List \$	Product No.	List \$
Acoustic Divider for T-Station (2 Person)						
60 x 60 x 60	• AXFAZ16	1750	AXFAZ28	1750	AXFAZ34	3025
60 x 60 x 72	AXFBZ16	1753	AXFBZ28	2190	AXFBZ34	3026
72 x 72 x 60	AXFCZ16	1750	AXFCZ28	2631	AXFCZ34	3027
72 x 72 x 72	AXFDZ16	1759	AXFDZ28	3071	AXFDZ34	3029
Acoustic Divider for Y-Station (3 Person)						
60 x 60 x 60	AXGAZ16	1750	• AXGAZ28	1750	AXGAZ34	3025
72 x 72 x 72	AXGDZ16	1759	AXGDZ28	3071	AXGDZ34	3029
Acoustic Divider for X-Station (4 Person)						
60 x 60 x 60 x 60	AXHAZ16	2244	AXHAZ28	1752	• AXHAZ34	3028
60 x 72 x 60 x 72	AXHBZ16	2250	AXHBZ28	3125	AXHBZ34	3947
72 x 72 x 72 x 72	AXHDZ16	2256	AXHDZ28	4006	AXHDZ34	3949

! Notes:

Divider Screen Product Numbers include a complete set of divider screens for the panel system layout.
Ex. AXFAZ16 Includes three 16h Acoustic Divider Screens to be used with the item number AXFA panel sytem listed on page AAX6.
Acoustic Panels are Not Self-Healing. They Should Not be Used as Tackable Panels.

+ Options:

Specify Acoustic Color: Carbon, Graphite, Snow, Taupe, Whisper. Other Colors Available Upon Request.

Acoustic Standard Color Options:



Other colors available upon request:



Product Variances | Variation in fiber and color and patterning may occur.

Due to the nature of non-woven materials, light may pass through in any thickness or color. A translucent appearance is most apparent in lighter colors and thin material when a light source is present behind the material. Tuohy makes no claims or warranties about the material performing as opaque in any circumstance. To verify a products performance for light transmittance, a mockup of the specific intended use is recommended.

