



PRICING & SPECIFICATION GUIDE  
Occasional Tables

May 1, 2023

TUOHY

## Index

360-361	E3
Airde	E4
Arcelle	E5
Bau	E6
Domino	E7
Genevieve	E8
International	E9
Moderna	E10
Oblique	E11
Salone	E12

360-361

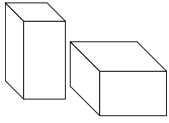

	Product No.	List \$
Square	Wood1 Finishes	
360 Table 18w 18d 15h	360.1811	1704
360 Table 21w 21d 15h	360.2111	1850
• 360 Table 24w 24d 15h	360.2411	2022
360 Table 30w 30d 15h	360.3011	2314
360 Table 48w 48d 15h	360.4811	3316
360 Table 24w 24d 21h	360.2421	2276
360 Table 30w 30d 21h	360.3021	2620
• 360 Table 15w 15d 28h	360.1531	2069

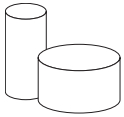

	Product No.	List \$
Circular	Wood1 Finishes	
361 Table 18 diam 15h	361.1811	1680
361 Table 24 diam 15h	361.2411	1850
• 361 Table 30 diam 15h	361.3011	2356
361 Table 36 diam 15h	361.3611	3003
361 Table 42 diam 15h	361.4211	4601
361 Table 48 diam 15h	361.4811	4883
361 Table 24 diam 21h	361.2421	2050
361 Table 30 diam 21h	361.3021	2482
• 361 Table 15 diam 28h	361.1528	2035

Airde Tables

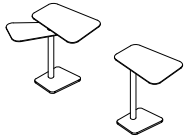
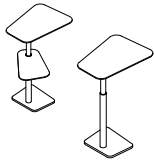

	Prod.No. Prefix...	...Top Material Code... / List \$		
		Wood 1 ...W1...	Wood 2 ...W2...	AcrylicSS ...C...
Fixed Height 26h				
• Swivel	ADFS...	2558	2737	2775
• No Swivel (No Lower Top)	ADFN...	1911	2045	2141

Base and Column Color: ...Suffix  
 MRW Resin White ...W  
 MRB Resin Black ...B  
 MRSA Resin Satin Aluminum ...R  
 MRTG Resin Thunder Gray ...T

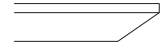
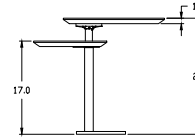

	Prod.No. Prefix...	...Top Material Code... / List \$		
		Wood 1 ...W1...	Wood 2 ...W2...	AcrylicSS ...C...
Adjustable Height 21.2h - 31.1h				
• Swivel	ADAS...	2833	3031	3049
• No Swivel (No Lower Top)	ADAN...	2114	2262	2344

Base and Column Color: ...Suffix  
 MRW Resin White ...W  
 MRB Resin Black ...B  
 MRSA Resin Satin Aluminum ...R  
 MRTG Resin Thunder Gray ...T

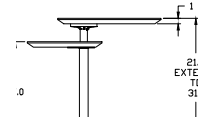

> To Order:

For product numbers, append Top Material Code to Prefix Code and add Base and Column Color suffix code. For List \$, read across at Prefix Code and down from Top Material Code; price includes Base and Column Color.

Ex.: For Fixed Height, No Swivel, Wood1 Top, and White Base and Column Color; the product number is ADFNW1W, and list price is \$1911.

Guide to specifying top materials:

Wood1: All TUOHY Wood1 offerings.

Wood2: All TUOHY Wood2 offerings.

Acrylic Solid Surface: Avonite® Polaris Matte

! Notes:

Swivel is only on the lower top; rotation is 235 degrees.

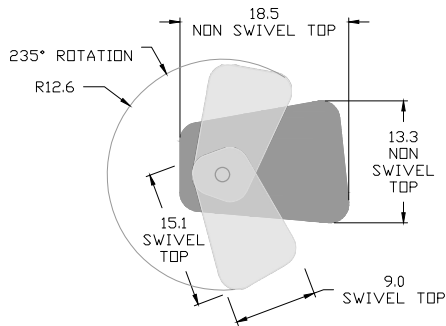

Arcelle Tables/Consoles

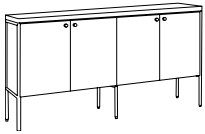
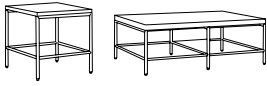

Steel Leg Frame, 2-in Thick Tops

	Product No.	List \$
• End Table 22w 22d 22h	119.4001	2789
• Low Table 48w 32d 18h	119.4002	4036
• Console Table 42w 16d 29.9h	119.4004	4570
• Console Table 60w 16d 29.9h	119.4003	4920
• Console Cabinet 72w 18d 38h	119.4005	10905

! Notes:

Metal legs have a MPC Polished Chrome finish.

Prices shown are for tops and cabinets in TUOHY Wood1 finishes.

Customer-supplied stone tops may be applied (template provided); specify Option ST.

Console Cabinet units are standard with unfinished backs.

+ Options:

For finished back on a Console Cabinet unit, change the 4th digit from 4 to 5; add \$299.

> See also: Arcelle Lounge in Seating.



Bau Tables



Prefix...	Resin					Polished		Wood2 Option/Add\$
	Black	White	SatAlum	ThunGray	BrAlumSt	Aluminum		
Wood1 Top/End Panel 16h	...MRB	...MRW	...MRSA	...MRTG...	...MRBAS	...MPA	Option W2	
Bau Table 36w 21d 16h	BAT36...	5299	5299	5299	5299	5849 6622	350	
Bau Table 48w 21d 16h	BAT48...	5606	5606	5606	5606	6155 6929	350	
Bau Table 60w 21d 16h	BAT60...	5642	5642	5642	5642	6191 6965	350	
Bau Table 72w 21d 16h	BAT72...	5712	5712	5712	5712	6261 7035	350	

Prefix...	Resin					Polished		Wood2 Option/Add\$
	Black	White	SatAlum	ThunGray	BrAlumSt	Aluminum		
Wood1 Top/End Panel 21h	...MRB	...MRW	...MRSA	...MRTG...	...MRBAS	...MPA	Option W2	
Bau Table 21w 21d 21h	BAT21...	5054	5054	5054	5054	5603 6377	350	
Bau Table 27w 16d 21h	BAT27...	5103	5103	5103	5103	5652 6426	350	

! Notes:

Blade leg is aluminum; see individual listings for finish and append suffix code to the prefix code.  
Table tops and end panels are standard in Wood1 species/finishes.

+ Options:

For Wood2 species/finishes, specify Option W2 and add amount shown at far right.

> See also: Bau Table-Benches in Seating.

Domino Tables



	Prefix...	...Top Material Code.../List \$ (see base finish notes at bottom)								Add \$—Base Finish	
		AEGlass	GlassBP	AcrylicSS	Marble	Quartz	Wood1	Wood2	BrNickel	PolChrome	
<b>Rounds/Resin Base</b>		...A...	...B...	...C...	...M...	...Q...	...W1...	...W2...	...MBN	...MPC	
End Table 20 diam 21h	DMC20...	1887	1859	1846	2182	2387	1323	1416	+421	+524	
Low Table 30 diam 16h	DMC30...	2958	2951	3300	3671	4316	2129	2278	+480	+583	
Low Table 36 diam 16h	DMC36...	4098	3789	4368	5044	5928	2689	2877	+512	+628	
Low Table 42 diam 16h	DMC42...	5106	4739	5758	6231	7792	3333	3566	+553	+676	



	Prefix...	...Top Material Code.../List \$ (see base finish notes at bottom)								Add \$—Base Finish	
		...A	...B	...C	...M	...Q	...W1	...W2	MBN	MPC	
<b>Squares/Resin Base</b>		...A	...B	...C	...M	...Q	...W1	...W2	MBN	MPC	
End Table 19w 19d 21h	DMS19...	1490	1456	1594	2035	2233	1230	1316	+421	+524	
Low Table 30w 30d 16h	DMS30...	2452	2457	2893	3466	4112	1708	1828	+480	+583	
Low Table 36w 36d 16h	DMS36...	3259	3183	3761	4775	5657	2135	2284	+512	+628	
Low Table 42w 42d 16h	DMS42...	4647	4558	4932	5880	7441	2628	2812	+553	+676	



	Prefix...	...Top Material Code.../List \$ (see base finish notes at bottom)								Add \$—Base Finish	
		...A	...B	...C	...M	...Q	...W1	...W2	MBN	MPC	
<b>Rectangles/Resin Base</b>		...A	...B	...C	...M	...Q	...W1	...W2	MBN	MPC	
Low Table 30w 20d 16h	DMR30...	2390	2325	3134	3409	4424	1964	2101	+676	+790	
Low Table 48w 24d 16h	DMR48...	3068	3079	4424	4663	5781	2439	2610	+918	+1038	
Low Table 60w 24d 16h	DMR60...	4092	4074	6259	6283	6802	2832	3030	+1062	+1204	

! Notes:

Product numbers are formed by merging the Prefix Code, Top Material Code, and Base Code.

Guide to top materials:

- AEGlass (Acid-Etched): GAB Acid-Etched Black or GAW Acid-Etched White
- BPGlass (Back-Painted): S.BLK Black or S.BWT White
- Acrylic Solid Surface: Avonite® Polaris Matte
- Marble: Carrara
- Quartz: Cambria® (all standard colors; Cambria Matte™ & Luxury Series Designs require quote)
- Wood1: All TUOHY Wood1 offerings.
- Wood2: All TUOHY Wood2 offerings.

+ Specify base finishes:

- |                       |                   |  |
|-----------------------|-------------------|--|
| <i>For:</i>           | <i>Base Code:</i> | <i>Adjust Price:</i>                             |
| Resin Black           | ...MRB            | no surcharge.                                    |
| Resin White:          | ...MRW            | no surcharge.                                    |
| Resin Satin Aluminum: | ...MRSA           | no surcharge.                                    |
| Brushed Nickel:       | ...MBN            | add price shown above, second column from right. |
| Polished Chrome:      | ...MPC            | add price shown above, far right column.         |



Genevieve Tables

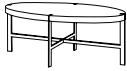

	Product No.	List \$	Product No.	List \$
<b>Wood1: Round</b>				
Resin Brushed Steel			Polished Chrome	
Low Table 31 diam 16h	GD3116WR	4436	GD3116W	4908
• Low Table 36 diam 16h	GD3616WR	4604	GD3616W	4992
• End Table 22 diam 21h	GD2221WR	4232	GD2221W	4639
<b>Wood1: Oval/Ellipse</b>				
Resin Brushed Steel			Polished Chrome	
• Low Table 42w 22d 16h	GE224216WR	4835	GE224216W	5103
<b>Wood1: Square/Rectangle</b>				
Resin Brushed Steel			Polished Chrome	
Low Table 22w 22d 16h	G222216WR	4121	G222216W	4557
Low Table 42w 22d 16h	G224216WR	4836	G224216W	5103
Low Table 30w 30d 16h	G303016WR	4423	G303016W	4791
Low Table 36w 36d 16h	G363616WR	4541	G363616W	4887
• End Table 18w 27d 21h	G271821WR	4433	G271821W	4736
End Table 27w 27d 21h	G272721WR	4519	G272721W	4939

! Notes:

Wood top pricing is shown at Wood1 level; Wood2 woods/finishes are also available.

Metal finish is MRBS Resin Brushed Steel or MPC Polished Chrome; specify Product Number and price above.

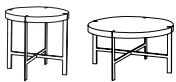

	Product No.	List \$	Product No.	List \$
<b>AcrylicSS Top: Round</b>				
Resin Brushed Steel			Polished Chrome	
Low Table 31 diam 16h	GD3116CR	6230	GD3116C	6549
• Low Table 36 diam 16h	GD3616CR	6679	GD3616C	6889
• End Table 22 diam 21h	GD2221CR	5762	GD2221C	6017
<b>AcrylicSS Top: Oval/Ellipse</b>				
Resin Brushed Steel			Polished Chrome	
• Low Table 42w 22d 16h	GE224216CR	7180	GE224216C	7434
<b>AcrylicSS Top: Square/Rectangle</b>				
Resin Brushed Steel			Polished Chrome	
Low Table 22w 22d 16h	G222216CR	5114	G222216C	5418
Low Table 42w 22d 16h	G224216CR	6760	G224216C	7014
Low Table 30w 30d 16h	G303016CR	5526	G303016C	5920
Low Table 36w 36d 16h	G363616CR	6078	G363616C	6420
• End Table 18w 27d 21h	G271821CR	5229	G271821C	5492
End Table 27w 27d 21h	G272721CR	5418	G272721C	5754

! Notes:

Acrylic Solid Surface is Avonite® Polaris.

Metal finish is MRBS Resin Brushed Steel or MPC Polished Chrome; specify Product Number and price above.

> See also: Genevieve Lounge Seating

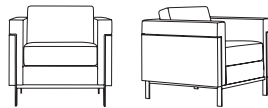



International Tables



	Product No.	List \$	Product No.	List \$
<b>Round</b>			<b>Resin Brushed Steel</b>	<b>Polished Chrome</b>
Low Table 36 diam 16h	N36D16R	4618	N36D16	5434
End Table 22 diam 20h	N22D20R	3599	N22D20	4234
<b>Square/Rectangle</b>			<b>Resin Brushed Steel</b>	<b>Polished Chrome</b>
Low Table 22w 42d 16h	N224216R	3801	N224216	4473
Low Table 36w 36d 16h	N363616R	4190	N363616	4929
End Table 18w 27d 20h	N182720R	3234	N182720	3803
End Table 27w 27d 20h	N272720R	3598	N272720	4233

! Notes:

Tops are 0.5-inch thick, tempered low iron glass.

Metal finish is MRBS Resin Brushed Steel or MPC Polished Chrome; specify Product Number and price above.

> See also: International and International-II Lounge Seating

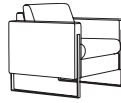

Moderna Tables

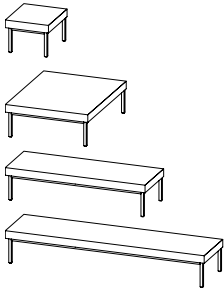

	Prod.No. Prefix...	...Top Material Code				
		Wood1	Wood2	AcrylicSS	Quartz	Marble
Freestanding		...W1	...W2	...C	...Q	...M
Side/Low Table 18w 18d 13h	MT1818...	2646	2831	3833	4599	4641
Low Table 36w 36d 13h	MT3636...	4049	4332	6122	7235	7308
Low Table 56w 18d 13h	MT5618...	4137	4427	6237	7308	7424
Low Table 84w 18d 13h	MT8418...	5166	5528	7189	11230	11172

! Notes:

Specify the product number by appending the desired Top Material Code to the Prod.No. Prefix.

Example: Side/Low Table with Wood1 top is MT1818W1; price is \$2646.

Standard metal finish is MBN Brushed Nickel.

Acrylic Solid Surface is Avonite® Polaris.





Quartz is all standard colors from Cambria®; Cambria Matte™ and Luxury Series Designs require quotation.

Marble is Carrara.

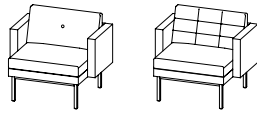
Other top materials are available on a COM/project basis.

> See also: Moderna Seating



	Prefix Code...	...Material Code/List \$										
		Wood1	Wood2									
Oblique Tables 	Wood Base, Self-Top	...W1	...W2									
	• 24 diam 13.3h	BL24AST...	4548	4866								
	36 diam 13.3h	BL36AST...	5357	5732								
	12 diam 17.3h	BL12BST...	4112	4400								
	24 diam 17.3h	BL24BST...	4678	5005								
	19 diam 21.3h	BL19CST...	4490	4804								
	14 diam 27.3h	BL14DST...	4392	4699								
	Wood1 Base, Applied Top	Prefix Code	Wood1	Wood2	AcrylicSS	AEGlass	AELGlass	BPGlass	HPL	Marble	Quartz	
	24 diam 14h	BL24AATW1...	na	na	5404	5696	5792	5255	5163	6159	5481	
	• 36 diam 14h	BL36AATW1...	na	na	6660	7782	7792	6788	6145	8884	7674	
	12 diam 18h	BL12BATW1...	na	na	4868	4592	5013	4487	4797	4854	4674	
	24 diam 18h	BL24BATW1...	na	na	5620	5913	6008	5472	5378	6376	5696	
	19 diam 22h	BL19CATW1...	na	na	5200	5213	5297	4905	5078	5646	5025	
	14 diam 28h	BL14DATW1...	na	na	5057	4827	5166	4678	4965	5192	4898	
	Wood2 Base, Applied Top	Prefix Code	Wood1	Wood2	AcrylicSS	AEGlass	AELGlass	BPGlass	HPL	Marble	Quartz	
	24 diam 14h	BL24AATW2...	na	na	5818	6110	6206	5669	5577	6573	5895	
	36 diam 14h	BL36AATW2...	na	na	7361	8482	8492	7490	6845	9584	8375	
	12 diam 18h	BL12BATW2...	na	na	5077	4802	5223	4697	5007	5064	4884	
	• 24 diam 18h	BL24BATW2...	na	na	6138	6430	6526	5989	5897	6893	6215	
	19 diam 22h	BL19CATW2...	na	na	5773	5787	5871	5478	5651	6219	5599	
	14 diam 28h	BL14DATW2...	na	na	5420	5191	5529	5042	5329	5557	5263	
	Faux Leather Base, Applied Top	Prefix Code	Wood1	Wood2	AcrylicSS	AEGlass	AELGlass	BPGlass	HPL	Marble	Quartz	
	24 diam 14h	BL24ALB...	4778	5112	4972	5265	5360	4824	4730	5728	5048	
	36 diam 14h	BL36ALB...	5151	5512	5566	6687	6699	5695	5051	7790	6581	
	• 12 diam 18h	BL12BLB...	4623	4947	4680	4404	4826	4300	4610	4666	4487	
	24 diam 18h	BL24BLB...	5096	5453	5290	5583	5678	5142	5048	6046	5367	
	19 diam 22h	BL19CLB...	4801	5137	4889	4902	4986	4594	4767	5335	4715	
	14 diam 28h	BL14DLB...	4812	5149	4886	4657	4995	4508	4794	5022	4728	

> To Order:

For product numbers, append Top Material Code to Prefix Code; read across and down for list price.  
 Ex. For Tapered Base with Self Top, 24 diam 13.3h, in Wood1, product number is BL24ASTW1; list price is \$4548.

Material, applied top thickness (where applicable), and available color choices to specify:

- Acrylic Solid Surface: 0.5in Avonite® Polaris Matte
- AEGlass (Acid-Etched): 0.5in GAB Acid-Etched Black or GAW Acid-Etched White
- AELGlass (Acid-Etched): 0.5in O.LCG Castlegate Gray, O.LCW Cool White, or O.LSH Stone Harbor
- BPGlass (Back-Painted): 0.5in S.BLK Black or S.BWT White
- Faux Leather: – All TUOHY Silex colors
- HPL: 0.75in 949 White
- Marble: 2cm Carrara
- Quartz: 2cm Cambria® Classic or Signature Series (all colors); quote required for Luxury and Matte offerings.
- Wood1: 0.75in All TUOHY Wood1 offerings
- Wood2: 0.75in All TUOHY Wood2 offerings

! Notes:

See above for Applied tops thickness. Heights are nominal and are dependent on top thickness.  
 Base diameters are nominal.  
 12-14 diameter tables have an access hole of 5 inches; 19-36 diameter tables have an access hole of 8 inches.  
 Available with vertical grain direction only.

+ Options:

See power data options price list for Node in surface power that can be used as power option.

» See also: Oblique Conference Tables

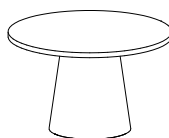

WorkStyles Tiered Table

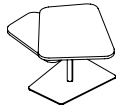

Square

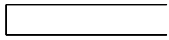

Knife

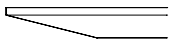

Pillow (n/a on Wood1 Tops)

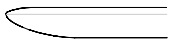

Product No. List \$

26.2h	Wood1 Tops	AcrylicSS Tops		Solid Walnut Tops	
Resin Base	TYTWP	3039	TYTCP	3641	TYTSP 4217
Brushed Base	TYTWB	3269	TYTCB	3871	TYTSB 4446

! Notes:

1-in thick tops swivel independently of each other.

Acrylic Solid Surface is Avonite® Polaris.

Brushed Base finish is MRBS Resin Brushed Steel.

+ Options:

Specify edge shape on tops: S=Square, K=Knife, P=Pillow (n/a on Wood1 Tops).

Resin Base finish is MRTG Resin Thunder Gray. Also available:

MRW Resin White; no price change.

MRB Resin Black; no price change.

Inquire about custom base colors.

> See also: WorkStyles Collection for Individual and Group Work

