

TUOHY

# Atheneum



Casegoods: **Atheneum**

Drawer Layouts	AAT3
Desk-Tables	AAT4
Desks, Double Pedestal	AAT4
Desks, Single Pedestal	AAT6
Runoff24	AAT7
Runoff30	AAT8
Runoff36	AAT9
Bridge	AAT10
Credenzas	AAT11
Credenza Tops	AAT12
Base L/T Panels	AAT13
Modesty Panels	AAT13
Pedestals	AAT14
Hutch72	AAT15
Hutch85	AAT17
Wall Hutch	AAT19
Fabric Panels, Wall Hung	AAT20
Towers72	AAT21
Towers85	AAT22
Gallery Desks/Credenzas	AAT23
Gallery Runoffs/Bridges	AAT24

Design:  
**David Allan Pessa, New Studio**



**Drawer Layouts: Plan View**

Slides: Side-Mount

Pedestal Units 24d  
Drawers 20.1d

Pedestal Units 36d  
Drawers 27d

18w      30w      36w

18w

**Box Drawer w Movable Divider**

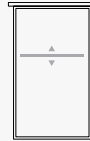
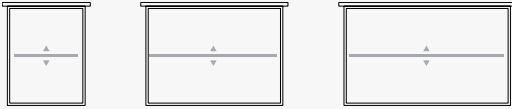

**Lateral Filing**

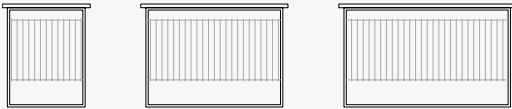
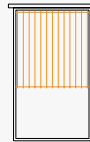
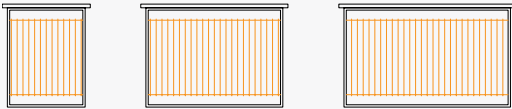

**Front-to-Back Filing**

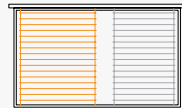

*DRAWER CONSTRUCTION*

A fine point for a quality casegood product is the inner drawer construction. Each TUOHY casegood offers you uncompromised excellence in this area as well. Drawer boxes are constructed with dovetail joinery for maximum durability. The drawer face is mounted separately to this box (i.e., five-sided construction) to maintain integrity.

Drawer bottoms are dadoed on all four sides. Slides for box drawers are rated at 100 pounds per drawer; slides for file drawers are rated at a heavy duty 150 pound load per drawer. All slides have progressive action.

Box drawers have a removable divider, adjustable when depicted (⇄). File drawers have suspension rods for filing laterally or front-to-back, as depicted.

For Drawers for Lap Area, Drawer Pencil Tray, and Locks: See the Introduction/Terms-Options section of the Master Price List, page 12.

Desks, Double Pedestal

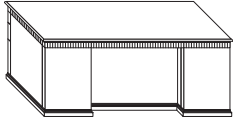
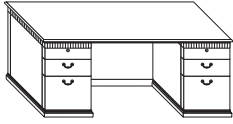

2BF-2BF ↯	w	d	29.9h	Detail All Sides	Product No.	List \$
Desk (4s): 2BF-2BF 66x30	67.7	31.7		69BBP00	19441	
Desk (4s): 2BF-2BF 72x30	73.7	31.7		69BBR00	19608	
• Desk (4s): 2BF-2BF 72x36	73.7	37.7		69BBR30	20078	
Desk (4s): 2BF-2BF 78x36	79.7	37.7		69BBT30	20642	
2F-2BF ↯	w	d	29.9h	Detail All Sides		
Desk (4s): 2F-2BF 66x30	67.7	31.7		69BBP01	19441	
Desk (4s): 2F-2BF 72x30	73.7	31.7		69BBR01	19608	
Desk (4s): 2F-2BF 72x36	73.7	37.7		69BBR31	20078	
Desk (4s): 2F-2BF 78x36	79.7	37.7		69BBT31	20642	
2BF-2F ↯	w	d	29.9h	Detail All Sides		
Desk (4s): 2BF-2F 66x30	67.7	31.7		69BBP02	19441	
Desk (4s): 2BF-2F 72x30	73.7	31.7		69BBR02	19608	
Desk (4s): 2BF-2F 72x36	73.7	37.7		69BBR32	20078	
Desk (4s): 2BF-2F 78x36	79.7	37.7		69BBT32	20642	
2F-2F ↯	w	d	29.9h	Detail All Sides		
Desk (4s): 2F-2F 66x30	67.7	31.7		69BBP03	19441	
Desk (4s): 2F-2F 72x30	73.7	31.7		69BBR03	19608	
Desk (4s): 2F-2F 72x36	73.7	37.7		69BBR33	20078	
Desk (4s): 2F-2F 78x36	79.7	37.7		69BBT33	20642	

Options

DeskPull-OutShelves		
Desk Shelf, User LH, Non-handed, or modular pedestals	Option SL	1544
Desk Shelf, User LH & RH	Option SB	3095
• Desk Shelf, User RH	Option SR	1544
• Desk Shelf, Visitor Knee Only	Option SK	1884
Desk Shelf, Visitor +User LH	Option SC	3434
Desk Shelf, Visitor +User LH & RH	Option SD	4985
Desk Shelf, Visitor +User RH	Option SA	3434

! Important: A Desk Shelf cannot be used on the visitor's side when a pencil lap drawer is used, or when Transaction Tops or Oversized Tops are used. User-side Desk-Shelf units may only be used on a 2-Box/File pedestal.

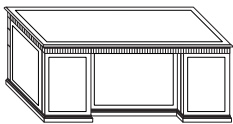

Quarter-Sawn Borders  
(Available on all Atheneum casegoods and tables)

Borders: All Outer Surfaces*	Option BA	50%
------------------------------	-----------	-----

\* Outer surfaces are defined to be:  
 Worksurfaces and upgraded finished tops for hutches or towers.  
 Vertical surfaces below the worksurface that have toeboards and are NOT in a kneespace area.  
 Vertical surfaces above the worksurface that have top edge detailing.

Desks, Double Ped w/ Oversized Top

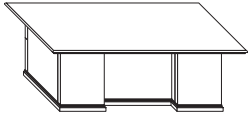

Visitor's Side

Overhang—Three Sides ↵	w	d	29.9h	Detail All Sides	
Desk/Oversized: 2BF-2BF 72x36	79.7	43.7		69BEP00	20622
Desk/Oversized: 2BF-2F 72x36	79.7	43.7		69BEP02	20622
Desk/Oversized: 2F-2BF 72x36	79.7	43.7		69BEP01	20622
Desk/Oversized: 2F-2F 72x36	79.7	43.7		69BEP03	20622

Note: Do not use a Desk Shelf on the visitor's side with these units.

Desks, Dbl Ped w/ Transaction Front

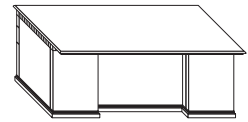
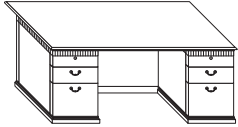

2BF-2BF ↵	w	d	29.9h	Detail All Sides	
Desk/Trans: 2BF-2BF 66x30	67.7	37.7		69BHP00	19870
Desk/Trans: 2BF-2BF 72x30	73.7	37.7		69BHR00	20178
• Desk/Trans: 2BF-2BF 72x36	73.7	43.7		69BHR30	20392
Desk/Trans: 2BF-2BF 78x36	79.7	43.7		69BHT30	20915

2F-2BF ↵	w	d	29.9h	Detail All Sides	
Desk/Trans: 2F-2BF 66x30	67.7	37.7		69BHP01	19870
Desk/Trans: 2F-2BF 72x30	73.7	37.7		69BHR01	20178
Desk/Trans: 2F-2BF 72x36	73.7	43.7		69BHR31	20392
Desk/Trans: 2F-2BF 78x36	79.7	43.7		69BHT31	20915

2BF-2F ↵	w	d	29.9h	Detail All Sides	
Desk/Trans: 2BF-2F 66x30	67.7	37.7		69BHP02	19870
Desk/Trans: 2BF-2F 72x30	73.7	37.7		69BHR02	20178
Desk/Trans: 2BF-2F 72x36	73.7	43.7		69BHR32	20392
Desk/Trans: 2BF-2F 78x36	79.7	43.7		69BHT32	20915

2F-2F ↵	w	d	29.9h	Detail All Sides	
Desk/Trans: 2F-2F 66x30	67.7	37.7		69BHP03	19870
Desk/Trans: 2F-2F 72x30	73.7	37.7		69BHR03	20178
Desk/Trans: 2F-2F 72x36	73.7	43.7		69BHR33	20392
Desk/Trans: 2F-2F 78x36	79.7	43.7		69BHT33	20915

Note: Do not use a Desk Shelf on the visitor's side with these units.

Desks, Single Pedestal

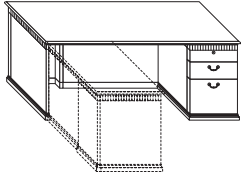

	w	d	29.9h	Flush Ends	\$ Detail All Sides		
2BF -							
Desk: LBase-2BF 66x30	66	31.7		69DAP10	12821	69DBP10	15290
Desk: LBase-2BF 72x30	72	31.7		69DAR10	13308	69DBR10	15638
• Desk: LBase-2BF 72x36	72	37.7		69DAR40	13569	• 69DBR40	15942
Desk: LBase-2BF 78x36	78	37.7		69DAT40	14294	69DBT40	16617
Desk: 2BF-LBase 66x30	66	31.7		69DAP20	12821	69DBP20	15290
Desk: 2BF-LBase 72x30	72	31.7		69DAR20	13308	69DBR20	15638
Desk: 2BF-LBase 72x36	72	37.7		69DAR50	13569	69DBR50	15942
Desk: 2BF-LBase 78x36	78	37.7		69DAT50	14294	69DBT50	16617

	w	d	29.9h	Flush Ends	\$ Detail All Sides		
2F -							
Desk: LBase-2F 66x30	66	31.7		69DAP11	12821	69DBP11	15290
Desk: LBase-2F 72x30	72	31.7		69DAR11	13308	69DBR11	15638
Desk: LBase-2F 72x36	72	37.7		69DAR41	13569	69DBR41	15942
Desk: LBase-2F 78x36	78	37.7		69DAT41	14294	69DBT41	16617
Desk: 2F-LBase 66x30	66	31.7		69DAP21	12821	69DBP21	15290
Desk: 2F-LBase 72x30	72	31.7		69DAR21	13308	69DBR21	15638
Desk: 2F-LBase 72x36	72	37.7		69DAR51	13569	69DBR51	15942
Desk: 2F-LBase 78x36	78	37.7		69DAT51	14294	69DBT51	16617

Desks, Sgl Ped w/ Transaction Front

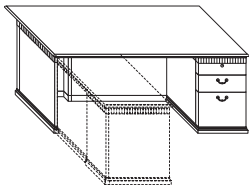

	w	d	29.9h	Flush Ends	\$ Detail All Sides		
2BF -							
Desk/Trans: LBase-2BF 66x30	66	37.7		69DGP18	13362	69DHP18	15831
Desk/Trans: LBase-2BF 72x30	72	37.7		69DGR18	14087	69DHR18	16430
• Desk/Trans: LBase-2BF 72x36	72	43.7		69DGR48	14376	• 69DHR48	16754
Desk/Trans: LBase-2BF 78x36	78	43.7		69DGT48	15089	69DHT48	17402
Desk/Trans: 2BF-LBase 66x30	66	37.7		69DGP28	13362	69DHP28	15831
Desk/Trans: 2BF-LBase 72x30	72	37.7		69DGR28	14087	69DHR28	16430
Desk/Trans: 2BF-LBase 72x36	72	43.7		69DGR58	14376	69DHR58	16754
Desk/Trans: 2BF-LBase 78x36	78	43.7		69DGT58	15089	69DHT58	17402

	w	d	29.9h	Flush Ends	\$ Detail All Sides		
2F -							
Desk/Trans: LBase-2F 66x30	66	37.7		69DGP19	13362	69DHP19	15831
Desk/Trans: LBase-2F 72x30	72	37.7		69DGR19	14087	69DHR19	16430
Desk/Trans: LBase-2F 72x36	72	43.7		69DGR49	14376	69DHR49	16754
Desk/Trans: LBase-2F 78x36	78	43.7		69DGT49	15089	69DHT49	17402
Desk/Trans: 2F-LBase 66x30	66	37.7		69DGP29	13362	69DHP29	15831
Desk/Trans: 2F-LBase 72x30	72	37.7		69DGR29	14087	69DHR29	16430
Desk/Trans: 2F-LBase 72x36	72	43.7		69DGR59	14376	69DHR59	16754
Desk/Trans: 2F-LBase 78x36	78	43.7		69DGT59	15089	69DHT59	17402

\$ Add 1.7 to width

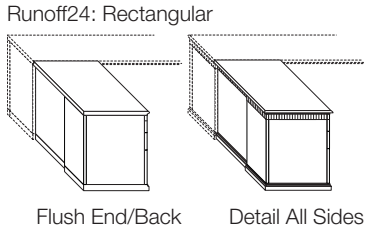

Product No.	List \$	Product No.	List \$
2BF ↯	w	24.9d	29.9h
Runoff24: 2BF LH 42	41.1	69FRH10	9307
Runoff24: 2BF LH 48	47.1	69FRJ10	9487
• Runoff24: 2BF LH 54	53.1	69FRL10	9839
Runoff24: 2BF RH 42	41.1	69FRH20	9307
Runoff24: 2BF RH 48	47.1	69FRJ20	9487
Runoff24: 2BF RH 54	53.1	69FRL20	9839

Product No.	List \$	Product No.	List \$
2F ↯	w	24.9d	29.9h
Runoff24: 2F LH 42	41.1	69FRH11	9307
Runoff24: 2F LH 48	47.1	69FRJ11	9487
Runoff24: 2F LH 54	53.1	69FRL11	9839
Runoff24: 2F RH 42	41.1	69FRH21	9307
Runoff24: 2F RH 48	47.1	69FRJ21	9487
Runoff24: 2F RH 54	53.1	69FRL21	9839

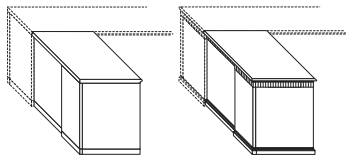

Product No.	List \$	Product No.	List \$
L-Base	w	24.9d	29.9h
Runoff24: LBase LH 42	41.1	69GRH10	5296
Runoff24: LBase LH 48	47.1	69GRJ10	5422
• Runoff24: LBase LH 54	53.1	69GRL10	5612
Runoff24: LBase LH 84	83.1	69GRV10	6746
Runoff24: LBase RH 42	41.1	69GRH20	5296
Runoff24: LBase RH 48	47.1	69GRJ20	5422
Runoff24: LBase RH 54	53.1	69GRL20	5612
Runoff24: LBase RH 84	83.1	69GRV20	6746

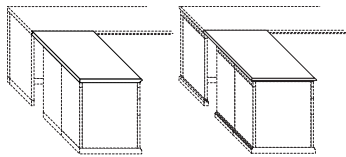

Product No.	List \$	Product No.	List \$
Top-Only (29.9h)	w	24.9d	1.5th
Runoff24 Top-Only: LH 42	41.1	69GTH10	3192
Runoff24 Top-Only: LH 48	47.1	69GTJ10	3374
• Runoff24 Top-Only: LH 54	53.1	69GTL10	3729
Runoff24 Top-Only: LH 60	59.6	69GTN10	3787
Runoff24 Top-Only: LH 72	71.1	69GTR10	3896
Runoff24 Top-Only: LH 84	83.1	69GTV10	4930
Runoff24 Top-Only: RH 42	41.1	69GTH20	3192
Runoff24 Top-Only: RH 48	47.1	69GTJ20	3374
Runoff24 Top-Only: RH 54	53.1	69GTL20	3729
Runoff24 Top-Only: RH 60	59.6	69GTN20	3787
Runoff24 Top-Only: RH 72	71.1	69GTR20	3896
Runoff24 Top-Only: RH 84	83.1	69GTV20	4930

§ Add 0.9 to w, d

TUOHY

Specify: Product No.  
Quantity  
Tagging  
Wood Finish

Hardware Finish:  
712 Satin Black  
713 Low Lustre Brass

For quarter-sawn borders, specify Option BA, add 50%.

- Denotes Item is illustrated.
- ↯ Includes locks.
- ‡ Requires field sub-assembly.

Available Species:  
**Cherry**  
**Mahogany**  
**Walnut**

Runoff30: Rectangular

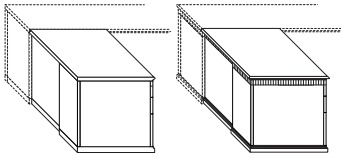

	Product No.	List \$	Product No.	List \$
2BF ↯				
• Runoff30: 2BF LH 48	69HAJ10	10778	69HBJ10	12470
Runoff30: 2BF LH 54	69HAL10	11034	69HBL10	12821
Runoff30: 2BF LH 60	69HAN10	11261	69HBN10	13056
Runoff30: 2BF LH 66	69HAP10	11531	69HBP10	13400
Runoff30: 2BF LH 72	69HAR10	11744	69HBR10	13714
Runoff30: 2BF RH 48	69HAJ20	10778	69HBJ20	12470
Runoff30: 2BF RH 54	69HAL20	11034	69HBL20	12821
Runoff30: 2BF RH 60	69HAN20	11261	69HBN20	13056
Runoff30: 2BF RH 66	69HAP20	11531	69HBP20	13400
Runoff30: 2BF RH 72	69HAR20	11744	69HBR20	13714
2F ↯				
Runoff30: 2F LH 48	69HAJ12	10778	69HBJ12	12470
Runoff30: 2F LH 54	69HAL12	11034	69HBL12	12821
Runoff30: 2F LH 60	69HAN12	11261	69HBN12	13056
Runoff30: 2F LH 66	69HAP12	11531	69HBP12	13400
Runoff30: 2F LH 72	69HAR12	11744	69HBR12	13714
Runoff30: 2F RH 48	69HAJ22	10778	69HBJ22	12470
Runoff30: 2F RH 54	69HAL22	11034	69HBL22	12821
Runoff30: 2F RH 60	69HAN22	11261	69HBN22	13056
Runoff30: 2F RH 66	69HAP22	11531	69HBP22	13400
Runoff30: 2F RH 72	69HAR22	11744	69HBR22	13714

§ Add 0.9 to w, d

TUOHY

Specify: Product No.  
Quantity  
Tagging  
Wood Finish

Hardware Finish:  
712 Satin Black  
713 Low Lustre Brass

For quarter-sawn borders, specify  
Option BA, add 50%.

- Denotes Item is illustrated.
- ↯ Includes locks.
- ‡ Requires field sub-assembly.

Available Species:  
**Cherry**  
**Mahogany**  
**Walnut**

Runoff36: Rectangular

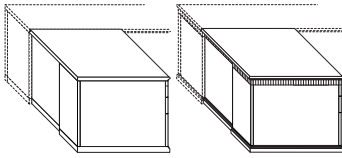

	Product No.	List \$	Product No.	List \$
2BF ↯			Flush End/Back	§ Detail All Sides
Runoff36: 2BF LH 48	69JAJ10	11490	69JBJ10	13190
• Runoff36: 2BF LH 54	69JAL10	11831	69JBL10	13626
Runoff36: 2BF LH 60	69JAN10	12155	69JBN10	13945
Runoff36: 2BF LH 66	69JAP10	12508	69JBP10	14383
Runoff36: 2BF LH 72	69JAR10	12821	69JBR10	14783
Runoff36: 2BF RH 48	69JAJ20	11490	69JBJ20	13190
Runoff36: 2BF RH 54	69JAL20	11831	69JBL20	13626
Runoff36: 2BF RH 60	69JAN20	12155	69JBN20	13945
Runoff36: 2BF RH 66	69JAP20	12508	69JBP20	14383
Runoff36: 2BF RH 72	69JAR20	12821	69JBR20	14783
2F ↯			Flush End/Back	§ Detail All Sides
Runoff36: 2F LH 48	69JAJ12	11490	69JBJ12	13190
Runoff36: 2F LH 54	69JAL12	11831	69JBL12	13626
Runoff36: 2F LH 60	69JAN12	12155	69JBN12	13945
Runoff36: 2F LH 66	69JAP12	12508	69JBP12	14383
Runoff36: 2F LH 72	69JAR12	12821	69JBR12	14783
Runoff36: 2F RH 48	69JAJ22	11490	69JBJ22	13190
Runoff36: 2F RH 54	69JAL22	11831	69JBL22	13626
Runoff36: 2F RH 60	69JAN22	12155	69JBN22	13945
Runoff36: 2F RH 66	69JAP22	12508	69JBP22	14383
Runoff36: 2F RH 72	69JAR22	12821	69JBR22	14783

§ Add 0.9 to w, d

TUOHY

Specify: Product No.  
Quantity  
Tagging  
Wood Finish

Hardware Finish:  
712 Satin Black  
713 Low Lustre Brass

For quarter-sawn borders, specify  
Option BA, add 50%.

- Denotes Item is illustrated.
- ↯ Includes locks.
- ‡ Requires field sub-assembly.

Available Species:  
**Cherry**  
**Mahogany**  
**Walnut**

Bridge, Fixed Modesty Panel

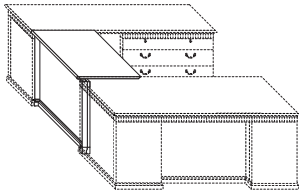

24 Depth ‡	w	24.9d	29.9h	Flush Back	\$ Detail Back	
Bridge24: 36	34.3			69GTF00	5180	69GVF00 5529
Bridge24: 42	40.3			69GTG00	5304	69GVG00 5665
• Bridge24: 48	46.3			69GTJ00	5414	69GVJ00 5768
Bridge24: 54	52.3			69GTL00	5840	69GVL00 6198

Finished back on fixed modesty panels.

Bridge, Removable Access Panel

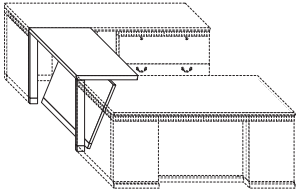

24 Depth (Unfinished Back) ‡	w	24.9d	29.9h	Flush Back	\$ Detail Back	
Bridge24/Access: 36	36.3			69GTF90	5220	69GVF90 5581
Bridge24/Access: 42	42.3			69GTG90	5324	69GVG90 5678
• Bridge24/Access: 48	48.3			69GTJ90	5422	69GVJ90 5782
Bridge24/Access: 54	54.3			69GTL90	5840	69GVL90 6198

Unfinished back on removable access panels.

Bridge, Top Only

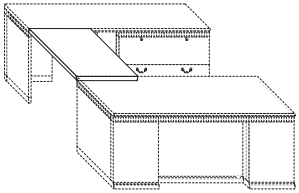

24 Depth	w	24.9d	29.9h	Flush Back	\$ Detail Back	
Bridge24Top: 36	36.3			69GWF00	3316	69GXF00 3682
Bridge24Top: 42	42.3			69GWG00	3358	69GXF00 3723
• Bridge24Top: 48	48.3			69GWJ00	3388	69GXJ00 3747
Bridge24Top: 54	54.3			69GWL00	3747	69GXL00 4110

§ Add 0.9 to depth

Credenzas-Freestanding

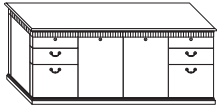

	73.7w 25.7d 29.9h	Detail 3 Sides	Product No.	List \$	Product No.	List \$
Continuous Top and Toeboards -						
Credenza (3s): 2BF x 4			69CZR00	18311		
• Credenza (3s): 2BF-DblCab-2BF			69CZR01	18311		
Credenza (3s): 2BF-DblCab-2F			69CZR02	18311		
Credenza (3s): 2F-DblCab-2BF			69CZR03	18311		
Credenza (3s): 2F-DblCab-2F			69CZR04	18311		
Credenza (3s): 2BF-Knee-2BF			69CZR31	17563		
Credenza (3s): 2BF-Knee-2F			69CZR32	17563		
Credenza (3s): 2F-Knee-2BF			69CZR33	17563		
Credenza (3s): 2F-Knee-2F			69CZR34	17563		
Credenza (3s): 2LatF-2LatF			69CZR35	17480		

Backs are unfinished.

Corner Credenzas

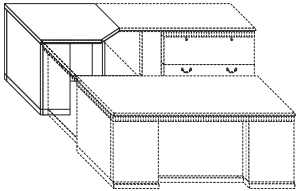

Attach Runoffs/Bridges a: b	w	d	29.9h	Flush Ends/Back	
• CornerCredenza 24:24	36.9	36.9		69LLCC0	3936
CornerCredenza 24:30	36.9	42.9		69LLCD0	4439
CornerCredenza 24:36	36.9	48.9		69LLCF0	4877
CornerCredenza 30:24	42.9	36.9		69LLDC0	4439
CornerCredenza 30:30	42.9	42.9		69LLDD0	4915
CornerCredenza 30:36	42.9	48.9		69LLDF0	5319
CornerCredenza 36:24	48.9	36.9		69LLFC0	4877
CornerCredenza 36:30	48.9	42.9		69LLFD0	5319
CornerCredenza 36:36	48.9	48.9		69LLFF0	5831

Backs are unfinished.

Grain is long when a and b are not equal.

Grain is as shown when a and b are equal.

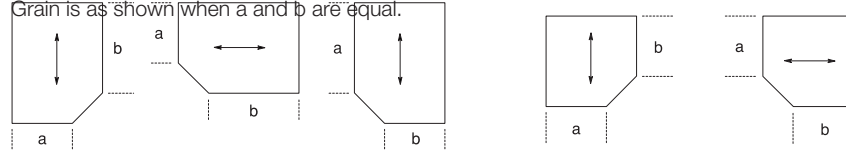

Computer Credenza Top+Base-L

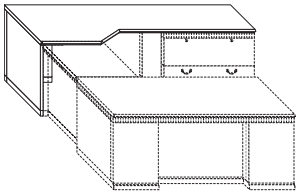

Base-L is 24x36, Unfinished Back ‡	w	36.9d	29.9h	Flush Ends/Back	\$ Detail 3 Sides	
CredenzaComp24: LH 72	72			69LBR31	5904	69LBR37 6986
• CredenzaComp24: LH 90	90			69LBW31	6198	69LBW37 7266
CredenzaComp24: LH 108	108			69LBY31	6783	69LBY37 7852
CredenzaComp24: RH 72	72			69LBR32	5904	69LBR38 6986
CredenzaComp24: RH 90	90			69LBW32	6198	69LBW38 7266
CredenzaComp24: RH 108	108			69LBY32	6783	69LBY38 7852

Backs are unfinished.

§ Add 0.9 to width

Computer Corner Adaptor Top

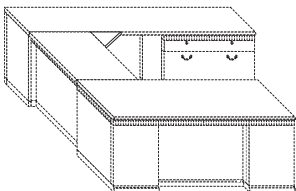

(Coped on two sides to mate with edge shapes of tops)					
Computer Corner Adaptor Top	12	12	1.5	69LCA01	698

Credenza Tops

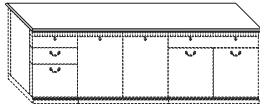
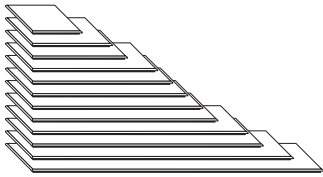
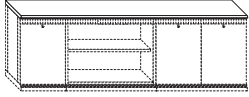
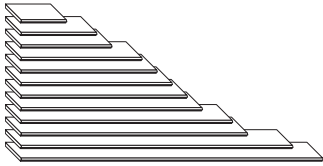

Support Keel

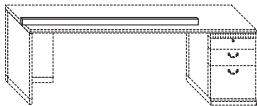

		Product No.	List \$	Product No.	List \$
Rectangular 15 Depth	w 15.9d 1.5th	Flush Ends/Back	\$ Detail 3 Sides		
CredenzaTop15: 18	18	69LAA00	2359	69LAA06	2804
CredenzaTop15: 30	30	69LAD00	2406	69LAD06	2857
CredenzaTop15: 36	36	69LAF00	2457	69LAF06	2907
CredenzaTop15: 48	48	69LAJ00	2482	69LAJ06	2926
CredenzaTop15: 54	54	69LAL00	2504	69LAL06	2959
CredenzaTop15: 60	60	69LAN00	2596	69LAN06	3046
CredenzaTop15: 66	66	69LAP00	2731	69LAP06	3180
CredenzaTop15: 72	72	69LAR00	2796	69LAR06	3247
CredenzaTop15: 78	78	69LAT00	2861	69LAT06	3303
CredenzaTop15: 84	84	69LAV00	2913	69LAV06	3358
• CredenzaTop15: 90	90	69LAW00	3095	69LAW06	3747
CredenzaTop15: 108	108	69LAY00	3675	69LAY06	4118
CredenzaTop15: 120	120	69LAZ00	4033	69LAZ06	4482

		Product No.	List \$	Product No.	List \$
Rectangular 24 Depth	w 24.9d 1.5th	Flush Ends/Back	\$ Detail 3 Sides		
CredenzaTop24: 18	18	69LAA30	2537	69LAA36	2981
CredenzaTop24: 30	30	69LAD30	2587	69LAD36	3032
CredenzaTop24: 36	36	69LAF30	2642	69LAF36	3083
CredenzaTop24: 48	48	69LAJ30	2660	69LAJ36	3109
CredenzaTop24: 54	54	69LAL30	2686	69LAL36	3127
CredenzaTop24: 60	60	69LAN30	2775	69LAN36	3219
CredenzaTop24: 66	66	69LAP30	2945	69LAP36	3388
CredenzaTop24: 72	72	69LAR30	3010	69LAR36	3465
CredenzaTop24: 78	78	69LAT30	3122	69LAT36	3519
CredenzaTop24: 84	84	69LAV30	3180	69LAV36	3566
• CredenzaTop24: 90	90	69LAW30	3305	69LAW36	3747
CredenzaTop24: 108	108	69LAY30	3985	69LAY36	4326
CredenzaTop24: 120	120	69LAZ30	4247	69LAZ36	4694

§ Add 1.7 to width

		Product No.	List \$
For unsupported spans of 54 or more.	w 2d 1h	Edge Profile Prefix not required.	
Support Keel: 52	52	70LDL00	699
Support Keel: 58	58	70LDN00	736
Support Keel: 64	64	70LDP00	880
• Support Keel: 70	70	70LDR00	1055
Support Keel: 82	82	70LDV00	1088
Support Keel: 88	88	70LDW00	1154
Support Keel: 106	106	70LDY00	1225
Support Keel: 118	118	70LDZ00	1397

Material is black resin-coated steel.

Base L/T Panels

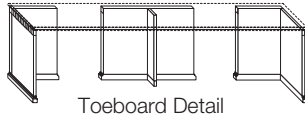
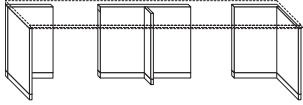

Unfinished Back ‡	w	d	28.4h	Flush Base	List \$	Product No.	List \$
Base-L15: LH 18	18	15		71MLA10	1154	69MLA18	1394
Base-L15: RH 18	18	15		71MLA20	1154	69MLA28	1394
• Base-L24: LH 18	18	24		71MLA40	1225	69MLA48	1464
Base-L24: LH 24	24	24		71MLC40	1337	69MLC48	1578
• Base-L24: RH 18	18	24		71MLA50	1225	69MLA58	1464
Base-L24: RH 24	24	24		71MLC50	1337	69MLC58	1578
Base-T9: 18	18	9		71MMA00	1298	69MMA08	1537
• Base-T9: 36	36	9		71MMF30	1781	69MMF38	2028

Finished Back ‡	w	d	28.4h	Flush Base	List \$	Product No.	List \$
Base-L15 Finished Back: LH 18	18	15		71MLA11	1388	69MLA19	1647
Base-L15 Finished Back: RH 18	18	15		71MLA21	1388	69MLA29	1647
Base-L24 Finished Back: LH 18	18	24		71MLA41	1479	69MLA49	1718
Base-L24 Finished Back: LH 24	24	24		71MLC41	1614	69MLC49	1826
Base-L24 Finished Back: RH 18	18	24		71MLA51	1479	69MLA59	1718
Base-L24 Finished Back: RH 24	24	24		71MLC51	1614	69MLC59	1826
Base-T9 Finished Back: 18	18	9		71MMA01	1544	69MMA09	1790
Base-T9 Finished Back: 36	36	9		71MMF31	2022	69MMF39	2283

§ Add 1.2 to w, d

Modesty Panels, Fixed

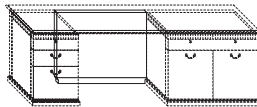
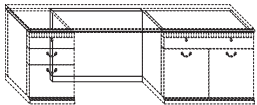

Unfinished Back ‡	w	1d	28.4h	Flush Base	List \$	Product No.	List \$
Modesty-Panel: 18	18			69MPA00	1057	69MQA00	1274
Modesty-Panel: 24	24			69MPC00	1093	69MQC00	1315
Modesty-Panel: 30	30			69MPD00	1247	69MQD00	1471
• Modesty-Panel: 36	36			69MPF00	1370	69MQF00	1592
Modesty-Panel: 42	42			69MPH00	1434	69MQH00	1650
Modesty-Panel: 48	48			69MPJ00	1506	69MQJ00	1726
Modesty-Panel: 54	54			69MPL00	1567	69MQL00	1785
Modesty-Panel: 72	72			69MPR00	1754	69MQR00	1972

Finished Back ‡	w	1d	28.4h	Flush Base	List \$	Product No.	List \$
Modesty-Panel Finished Back: 18	18			69MPA01	1449	69MQA01	1660
Modesty-Panel Finished Back: 24	24			69MPC01	1500	69MQC01	1713
Modesty-Panel Finished Back: 30	30			69MPD01	1675	69MQD01	1895
Modesty-Panel Finished Back: 36	36			69MPF01	1821	69MQF01	2034
Modesty-Panel Finished Back: 42	42			69MPH01	1895	69MQH01	2104
Modesty-Panel Finished Back: 48	48			69MPJ01	1990	69MQJ01	2205
Modesty-Panel Finished Back: 54	54			69MPL01	2053	69MQL01	2268
Modesty-Panel Finished Back: 72	72			69MPR01	2293	69MQR01	2503

§ Add 0.6 to depth

Modesty Panels, Access/Removable

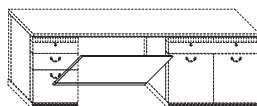

Unfinished Back (2.5 opening at top) ‡	w	3d	25.9h	Flush Base	List \$	Product No.	List \$
Modesty-Access: 18	18			69MPA90	1427		
Modesty-Access: 24	24			69MPC90	1464		
Modesty-Access: 30	30			69MPD90	1577		
• Modesty-Access: 36	36			69MPF90	1688		
Modesty-Access: 42	42			69MPH90	1748		
Modesty-Access: 48	48			69MPJ90	1821		
Modesty-Access: 54	54			69MPL90	1877		
Modesty-Access: 72	72			69MPR90	2099		

Pedestals

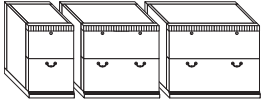
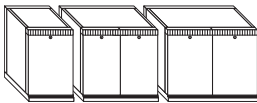
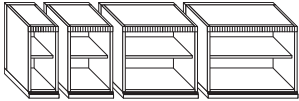
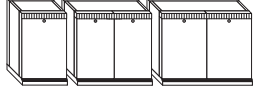
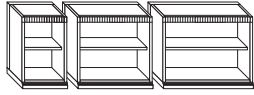

		Product No.	List \$	Product No.	List \$
15 Deep Shelving	w 15.6d 28.4h	Flush 3 Sides		\$ Toebd 4 Sides	
Ped15: Shelving 18	18	69MEA00	2919	69MEA01	3956
Ped15: Shelving 30	30	69MED00	3655	69MED01	4689
Ped15: Shelving 36	36	69MEF00	3983	69MEF01	5020
15 Deep Cabinets -	w 15.6d 28.4h	Flush 3 Sides		\$ Toebd 4 Sides	
Ped15: Cabinet LH 18	18	69MDA10	3838	69MDA11	4874
Ped15: Cabinet RH 18	18	69MDA20	3838	69MDA21	4874
Ped15: DblCabinet 30	30	69MDD00	4377	69MDD01	5416
Ped15: DblCabinet 36	36	69MDF00	4709	69MDF01	5754
24 Deep Shelving	w 24.6d 28.4h	Flush 3 Sides		\$ Toebd 4 Sides	
Ped24: ShelvingPC 12	12	69ME030	3062	69ME031	4015
Ped24: Shelving 18	18	69MEA30	3519	69MEA31	4459
Ped24: Shelving 30	30	69MED30	4313	69MED31	5349
Ped24: Shelving 36	36	69MEF30	4647	69MEF31	5693
24 Deep Cabinets -	w 24.6d 28.4h	Flush 3 Sides		\$ Toebd 4 Sides	
Ped24: Cabinet LH 18	18	69MDA40	4386	69MDA41	5333
Ped24: Cabinet RH 18	18	69MDA50	4386	69MDA51	5333
Ped24: DblCabinet 30	30	69MDD30	4842	69MDD31	5883
Ped24: DblCabinet 36	36	69MDF30	5117	69MDF31	6151
24 Deep File Drawers -	w 24.6d 28.4h	Flush 3 Sides		\$ Toebd 4 Sides	
Ped24: 2F 18	18	69MBA30	5127	69MBA31	6072
Ped24: 2LatF 30	30	69MBD30	6041	69MBD31	7082
Ped24: 2LatF 36	36	69MBF30	6550	69MBF31	7586
24 Deep 2Box-File Drawers -	w 24.6d 28.4h	Flush 3 Sides		\$ Toebd 4 Sides	
Ped24: 2BF 18	18	69MAA30	5127	69MAA31	6072
Ped24: 2LatB/LatF 30	30	69MAD30	6500	69MAD31	7542
Ped24: 2LatB/LatF 36	36	69MAF30	6993	69MAF31	8034
24 Deep 4Box and Box/Cabinets -	w 24.6d 28.4h	Flush 3 Sides		\$ Toebd 4 Sides	
Ped24: 4B 18	18	69MCA30	5304	69MCA31	6244
Ped24: LatB/DblCab 30	30	69MFD30	6219	69MFD31	7253
Ped24: LatB/DblCab 36	36	69MFF30	6706	69MFF31	7741
30 Deep (For Galleries) -	18w 30d 28.4h	Flush 3 Sides			
Ped30: 2F 18		69MBAD0	5209		
Ped30: 2BF 18		69MAAD0	5209		
36 Deep (For Galleries) -	18w 36d 28.4h	Flush 3 Sides			
Ped36: 2F 18		69MBAG0	6237		
Ped36: 2BF 18		69MAAG0	6237		

§ Add 0.6d, 1.3w

Pedestals that are Flush 3 sides have unfinished backs; otherwise pedestals are finished all sides.

+ Options:

For Toeboards Front & Back: Use Flush 3 Sides number, change last digit to 8 add \$529.



Flush 3 Sides



Toebd 4 Sides

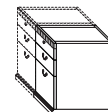

Toeboards Front+Back:

Hutch72

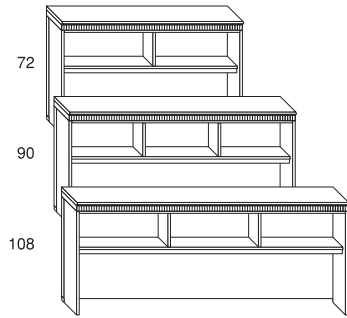

Shelving1 w. Wood Back	w	Sgl\Tbl Shlvs	Flush Ends/Back	\$ Detail 3 Sides	Product No.	List \$	Product No.	List \$
Hutch72: Shelving1 72	72	0\2	69PAR00	9456	69PAR07	10348		
Hutch72: Shelving1 90	90	1\2	69PAW00	10676	69PAW07	11568		
Hutch72: Shelving1 108	108	0\3	69PAY00	11422	69PAY07	12324		

Shelving1 w. Fabric Panel	w	Sgl\Tbl Shlvs	COM yd	Flush Ends/Back	\$ Detail 3 Sides	Product No.	List \$	Product No.	List \$
Hutch72: Shelving1/Fab 72	72	0\2	2.3	69PAR30	10709	69PAR37	11599		
Hutch72: Shelving1/Fab 90	90	0\3	2.8	69PAW30	12111	69PAW37	12994		
Hutch72: Shelving1/Fab 108	108	0\3	3.2	69PAY30	12948	69PAY37	13838		

Dimensions: width as listed 15d 45h  
 Note: Fabric Panels over 96w are produced in two sections. \$ Add 1.7 to width

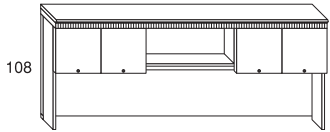

Cabinet1-Shelf w. Wood Back	w	Sgl\Tbl Shlvs	Flush Ends/Back	\$ Detail 3 Sides	Product No.	List \$	Product No.	List \$
Hutch72: Cab1-Shelf1-Cab1 108	108	0\3	69PFY00	12747	69PFY07	13728		

Cabinet1-Shelf w. Fabric Panel	w	Sgl\Tbl Shlvs	COM yd	Flush Ends/Back	\$ Detail 3 Sides	Product No.	List \$	Product No.	List \$
Hutch72: Cab1-Shelf1-Cab1/Fab 108	108	0\3	3.2	69PFY30	14270	69PFY37	15246		

Dimensions: width as listed 15d 45h  
 Note: Fabric Panels over 96w are produced in two sections. \$ Add 1.7 to width

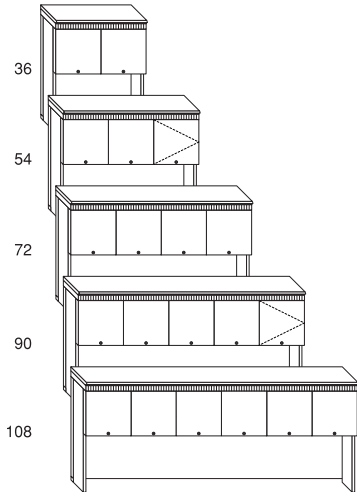

Cabinet1 w. Wood Back	w	Sgl\Tbl Shlvs	Flush Ends/Back	\$ Detail 3 Sides	Product No.	List \$	Product No.	List \$
Hutch72: Cabinet1 36	36	0\1	69PCF00	7572	69PCF07	8556		
Hutch72: Cabinet1 54	54	1\1	69PCL00	10173	69PCL07	11163		
Hutch72: Cabinet1 72	72	0\2	69PCR00	11427	69PCR07	12411		
Hutch72: Cabinet1 90	90	1\2	69PCW00	12279	69PCW07	13267		
Hutch72: Cabinet1 108	108	0\3	69PCY00	13182	69PCY07	14159		

Cabinet1 w. Fabric Panel	w	Sgl\Tbl Shlvs	COM yd	Flush Ends/Back	\$ Detail 3 Sides	Product No.	List \$	Product No.	List \$
Hutch72: Cabinet1/Fab 36	36	0\1	1.8	69PCF30	8289	69PCF37	9263		
Hutch72: Cabinet1/Fab 54	54	1\1	2	69PCL30	11335	69PCL37	12324		
Hutch72: Cabinet1/Fab 72	72	0\2	2.3	69PCR30	12686	69PCR37	13662		
Hutch72: Cabinet1/Fab 90	90	1\2	2.8	69PCW30	13714	69PCW37	14692		
Hutch72: Cabinet1/Fab 108	108	0\3	3.2	69PCY30	14692	69PCY37	15679		

Dimensions: width as listed 15d 45h  
 Note: Fabric Panels over 96w are produced in two sections. \$ Add 1.7 to width

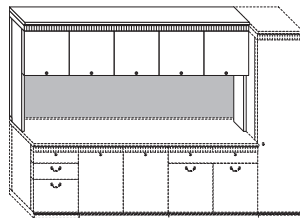

Cabinet1 Hutch w. Fabric Panel  
 Flush Ends/Back

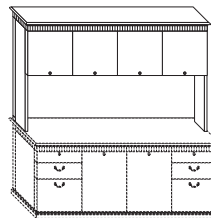

Cabinet1 Hutch w. Wood Back  
 Detail 3 Side

Hutch72 (cont.)

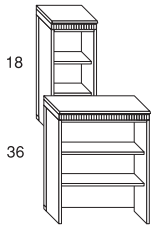

	w	Sgl\Tbl Shlvs	Flush Ends/Back	\$ Detail	3 Sides	Product No.	List \$	Product No.	List \$
Shelving3 w. Wood Back									
Hutch72: Shelving3 18	18	3\0	69PBA00	5970	69PBA07		6329		
Hutch72: Shelving3 36	36	0\3	69PBF00	7340	69PBF07		8312		

Dimensions: width as listed 15d 45h  
Includes one fixed shelf and one adjustable shelf. § Add 1.7 to width

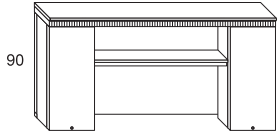

	w	Sgl\Tbl Shlvs	Flush Ends/Back	\$ Detail	3 Sides	Product No.	List \$	Product No.	List \$
Cab3-Shelf1 w. Wood Back									
Hutch72: Cab3-Shelf1-Cab3 90	90	6\1	69PGW00	14401	69PGW07		15375		

	w	Sgl\Tbl Shlvs	Flush Ends/Back	\$ Detail	3 Sides	Product No.	List \$	Product No.	List \$
Cab3-Shelf1 w. Fabric Panel									
Hutch72: Cab3-Shelf1/Fab-Cab3 90	90	6\1 2	69PGW30	15555	69PGW37		16529		

Dimensions: width as listed 15d 45h § Add 1.7 to width

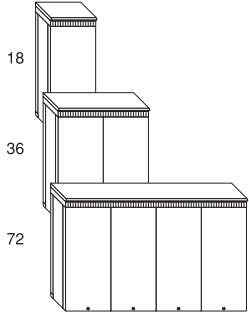

	w	Sgl\Tbl Shlvs	Flush Ends/Back	\$ Detail	3 Sides	Product No.	List \$	Product No.	List \$
Full Wood Doors									
Hutch72: Cabinet3 LH 18	18	3\0	69PEA10	6783	69PEA17		7132		
Hutch72: Cabinet3 RH 18	18	3\0	69PEA20	6783	69PEA27		7132		
Hutch72: Cabinet3 36	36	0\3	69PEF00	8682	69PEF07		9662		
Hutch72: Cabinet3 72	72	0\6	69PER00	15283	69PER07		15817		

Dimensions: width as listed 15d 45h § Add 1.7 to width

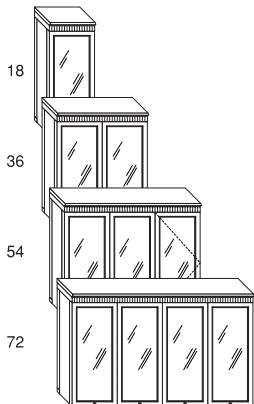

	w	Sgl\Tbl Shlvs	Flush Ends/Back	\$ Detail	3 Sides	Product No.	List \$	Product No.	List \$
Full Glass Doors									
Hutch72: GlassDrs3 LH 18	18	3\0	69PKA10	9008	69PKA17		9368		
Hutch72: GlassDrs3 RH 18	18	3\0	69PKA20	9008	69PKA27		9368		
Hutch72: GlassDrs3 36	36	0\3	69PKF00	11540	69PKF07		12520		
Hutch72: GlassDrs3 54	54	3\3	69PKL00	16247	69PKL07		17233		
Hutch72: GlassDrs3 72	72	0\6	69PKR00	20994	69PKR07		22071		

Dimensions: width as listed 15d 45h § Add 1.7 to width  
Includes clear glass shelves and low voltage LED lights.

TUOHY

Specify: Product No.  
Quantity  
Tagging  
Wood Finish

Hardware Finish:  
712 Satin Black  
713 Low Lustre Brass

For quarter-sawn borders, specify  
Option BA, add 50%.  
• Denotes item is illustrated.  
- Includes locks.

Available Species:  
**Cherry**  
**Mahogany**  
**Walnut**

Product No. List \$ Product No. List \$

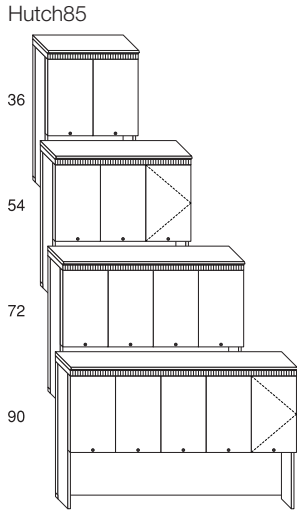

Cabinet2 w. Wood Back	w	Sgl\Tbl Shlvs	Flush Ends/Back	\$ Detail 3 Sides		
Hutch85: Cabinet2 36	36	0\2	69PSF00	8732	69PSF07	9718
Hutch85: Cabinet2 54	54	2\2	69PSL00	11422	69PSL07	12408
Hutch85: Cabinet2 72	72	0\4	69PSR00	12772	69PSR07	13755
Hutch85: Cabinet2 90	90	2\4	69PSW00	13714	69PSW07	14692

Cabinet2 w. Fabric Panel			COM			
Hutch85: Cabinet2/Fab 36	36	0\2	1.8	69PSF30	9442	69PSF37 10423
Hutch85: Cabinet2/Fab 54	54	2\2	2	69PSL30	12591	69PSL37 13569
Hutch85: Cabinet2/Fab 72	72	0\4	2.3	69PSR30	14021	69PSR37 15000
Hutch85: Cabinet2/Fab 90	90	2\4	2.8	69PSW30	15135	69PSW37 16115

Dimensions: width as listed 15d 57.6h

§ Add 1.7 to width

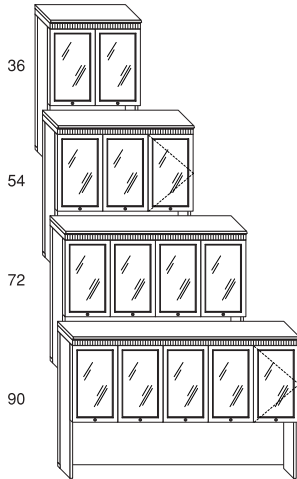

Glass Doors2 w. Wood Back	w	Sgl\Tbl Shlvs	Flush Ends/Back	\$ Detail 3 Sides		
Hutch85: GlassDrs2 36	36	0\2	69PWF00	11411	69PWF07	12390
Hutch85: GlassDrs2 54	54	2\2	69PWL00	15447	69PWL07	16430
Hutch85: GlassDrs2 72	72	0\8	69PWR00	17531	69PWR07	19113
Hutch85: GlassDrs2 90	90	2\4	69PWW00	20403	69PWW07	21385

Glass Doors2 w. Fabric Panel			COM			
Hutch85: GlassDrs2/Fab 36	36	0\2	1.8	69PWF30	12124	69PWF37 13106
Hutch85: GlassDrs2/Fab 54	54	2\2	2	69PWL30	16607	69PWL37 17594
Hutch85: GlassDrs2/Fab 72	72	0\4	2.3	69PWR30	19375	69PWR37 20361
Hutch85: GlassDrs2/Fab 90	90	2\4	2.8	69PWW30	21841	69PWW37 22815

Dimensions: width as listed 15d 57.6h

§ Add 1.7 to width

Includes clear glass shelves and low voltage LED lights.

TUOHY

Specify: Product No.  
Quantity  
Tagging  
Wood Finish

Hardware Finish:  
712 Satin Black  
713 Low Lustre Brass

For quarter-sawn borders, specify  
Option BA, add 50%.  
• Denotes Item is illustrated.  
→ Includes locks.

Available Species:  
**Cherry**  
**Mahogany**  
**Walnut**

Hutch85 (cont.)

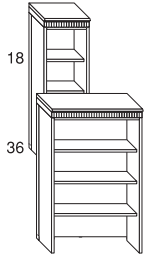

	w	Sg\Ndbl Shlvs	Flush Ends/Back	\$ Detail 3 Sides
Shelving4 Hutch				
Hutch85: Shelving4 18	18	4\0	69PQA00	6329 69PQA07 7220
Hutch85: Shelving4 36	36	0\4	69PQF00	8397 69PQF07 9390

Dimensions: width as listed 15d 57.6h  
Includes one fixed shelf and two adjustable shelves.

§ Add 1.7 to width

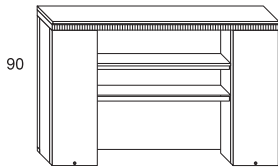

	w	Sg\Ndbl Shlvs	Flush Ends/Back	\$ Detail 3 Sides
Cab4-Shelf2 w. Wood Back				
Hutch85: Cab4-Shelf2-Cab4 90	90	8\2	69PVW00	15821 69PVW07 16807

Cab4-Shelf2 w. Fabric Panel COM

Hutch85: Cab4-Shelf2/Fab-Cab4 90	90	8\2	2 69PVW30	16990 69PVW37 17967
----------------------------------	----	-----	-----------	---------------------

Dimensions: width as listed 15d 57.6h

§ Add 1.7 to width

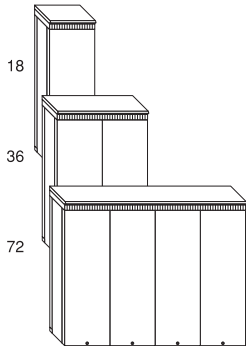

	w	Sg\Ndbl Shlvs	Flush Ends/Back	\$ Detail 3 Sides
Full Wood Doors				
Hutch85: Cabinet4 LH 18	18	4\0	69PTA10	7308 69PTA17 8204
Hutch85: Cabinet4 RH 18	18	4\0	69PTA20	7308 69PTA27 8204
Hutch85: Cabinet4 36	36	0\4	69PTF00	9843 69PTF07 10820
Hutch85: Cabinet4 72	72	0\4	69PTR00	17088 69PTR07 18068

Dimensions: width as listed 15d 57.6h

§ Add 1.7 to width

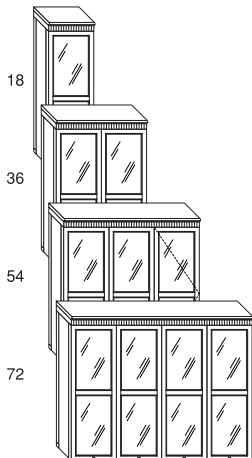

	w	Sg\Ndbl Shlvs	Flush Ends/Back	\$ Detail 3 Sides
Full Glass Doors				
Hutch85: GlassDrs4 LH 18	18	4\0	69PXA10	9913 69PXA17 10813
Hutch85: GlassDrs4 RH 18	18	4\0	69PXA20	9913 69PXA27 10813
Hutch85: GlassDrs4 36	36	0\4	69PXF00	12877 69PXF07 13855
Hutch85: GlassDrs4 54	54	4\4	69PXL00	18214 69PXL07 19197
Hutch85: GlassDrs4 72	72	0\8	69PXR00	23599 69PXR07 24678

Dimensions: width as listed 15d 57.6h  
Includes clear glass shelves and low voltage LED lights.

§ Add 1.7 to width

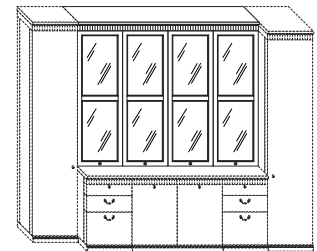

TUOHY

Specify: Product No.  
Quantity  
Tagging  
Wood Finish

Hardware Finish:  
712 Satin Black  
713 Low Lustre Brass

For quarter-sawn borders, specify  
Option BA, add 50%.  
• Denotes Item is illustrated.  
- Includes locks.

Available Species:  
**Cherry**  
**Mahogany**  
**Walnut**

Wall Hutch

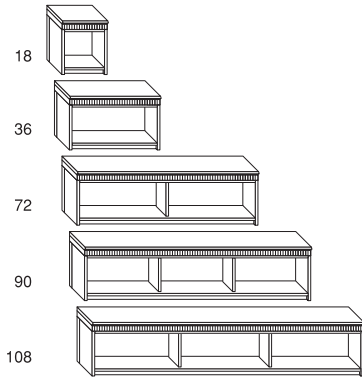

Shelving1 Wall Hutches	w	Sg\Ndbl Shlvs	Flush Ends/Back	\$ Detail 3 Sides	Product No.	List \$	Product No.	List \$
Hutch: Shelving1 18	18	1\0	69QAA00	3550	69QAA07	4358		
Hutch: Shelving1 36	36	0\1	69QAC00	4743	69QAC07	5639		
Hutch: Shelving1 72	72	0\2	69QAR00	8445	69QAR07	9339		
Hutch: Shelving1 90	90	0\3	69QAW00	9784	69QAW07	10592		
Hutch: Shelving1 108	108	0\3	69QAY00	11551	69QAY07	12440		

Dimensions: widths as listed 15.9d 21.7h  
Mounting cleats and hardware included.

§ Add 1.7 to width

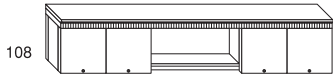

Cabinet1-Shelf1 Wall Hutch	w	Sg\Ndbl Shlvs	Flush Ends/Back	\$ Detail 3 Sides	Product No.	List \$	Product No.	List \$
Hutch: Cab1-Shelf1-Cab1 108	108	0\3	69QFY00	12224	69QFY07	13120		

Dimensions: widths as listed 15.9d 21.7h  
Mounting cleats and hardware included.

§ Add 1.7 to width

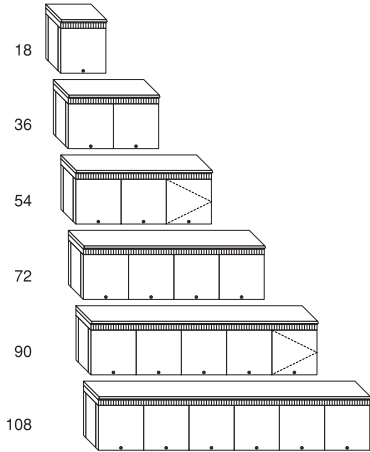

Cabinet1 Wall Hutches	w	Sg\Ndbl Shlvs	Flush Ends/Back	\$ Detail 3 Side	Product No.	List \$	Product No.	List \$
Hutch: Cabinet1 LH 18	18	1\0	69QCA10	3735	69QCA17	4548		
Hutch: Cabinet1 RH 18	18	1\0	69QCA20	3735	69QCA27	4548		
Hutch: Cabinet1 36	36	0\1	69QCC00	5715	69QCC07	6613		
Hutch: Cabinet1 54	54	1\1	69QCL00	8884	69QCL07	9771		
Hutch: Cabinet1 72	72	0\2	69QCR00	10248	69QCR07	11135		
Hutch: Cabinet1 90	90	1\2	69QCW00	11723	69QCW07	12617		
Hutch: Cabinet1 108	108	0\3	69QCY00	12938	69QCY07	13824		

Dimensions: widths as listed 15.9d 21.7h  
Mounting cleats and hardware included.

§ Add 1.7 to width

Hutches with an odd number of doors have a single cabinet, hinged right, on the right end. All other doors are paired in double cabinets.

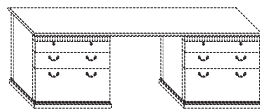
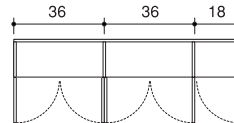

TUOHY

Specify: Product No.  
Quantity  
Tagging  
Wood Finish

Hardware Finish:  
712 Satin Black  
713 Low Lustre Brass

For quarter-sawn borders, specify Option BA, add 50%.

- Denotes Item is illustrated.
- ↪ Includes locks.

Available Species:  
**Cherry**  
**Mahogany**  
**Walnut**

Wall Hutch (cont.)

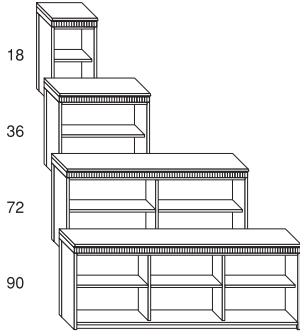

Shelving2 Wall Hatches	w	Sgl\Tbl Shlvs	Flush Ends/Back	\$ Detail 3 Sides	Product No.	List \$	Product No.	List \$
Hutch: Shelving2 18	18	2\0	69QNA00	4206	69QNA07	5009		
Hutch: Shelving2 36	36	0\2	69QNF00	6509	69QNF07	7404		
Hutch: Shelving2 72	72	0\4	69QNR00	11593	69QNR07	12487		
Hutch: Shelving2 90	90	0\6	69QNW00	13354	69QNW07	14245		

Dimensions: width as listed 15.9d 34.3h  
Mounting cleats and hardware included.

§ Add 1.7 to width

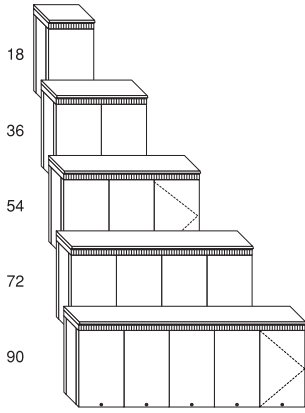

Cabinet2 Wall Hatches	w	Sgl\Tbl Shlvs	Flush Ends/Back	\$ Detail 3 Sides	Product No.	List \$	Product No.	List \$
Hutch: Cabinet2 LH 18	18	2\0	69QRA10	4576	69QRA17	5385		
Hutch: Cabinet2 RH 18	18	2\0	69QRA20	4576	69QRA27	5385		
Hutch: Cabinet2 36	36	0\2	69QRF00	7102	69QRF07	7998		
Hutch: Cabinet2 54	54	2\2	69QRL00	10042	69QRL07	10936		
Hutch: Cabinet2 72	72	0\4	69QRR00	12975	69QRR07	13875		
Hutch: Cabinet2 90	90	2\4	69QRW00	14866	69QRW07	15757		

Dimensions: width as listed 15.9d 34.3h  
Mounting cleats and hardware included.

§ Add 1.7 to width

Fabric Panels, Wall Hung

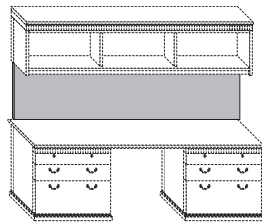

23.4 Height ±	w	23.4h	COM yd	Product No.	List \$
Fabric Wall Panel: 36	36	1.8	70PAF11	699	
Fabric Wall Panel: 54	54	2	70PAL11	1140	
• Fabric Wall Panel: 72	72	2.3	70PAR11	1225	
Fabric Wall Panel: 90	90	2.8	70PAW11	1397	
Fabric Wall Panel: 108	108	3.2	70PAY11	1487	

36 Height ±	w	36h	COM yd	Product No.	List \$
Fabric Wall Panel: 36X	36	1.8	70PAF21	699	
Fabric Wall Panel: 54X	54	2	70PAL21	1140	
Fabric Wall Panel: 72X	72	2.3	70PAR21	1225	
Fabric Wall Panel: 90X	90	2.8	70PAW21	1397	
Fabric Wall Panel: 108X	108	3.2	70PAY21	1487	

36 Height units are not recommended for use with Shelving2 or Cabinet2 Wall Hatches.

Mounting cleats and hardware included.

Wall Hung Fabric Panels allow for cord passage between the panel and the wall.

Note: Fabric Panels over 96w are produced in two sections.

Shipping address for COM/COL materials and memo samples:

TUOHY Furniture Corporation, P1 Upholstery Receiving, 42 Saint Albans Place, Chatfield, MN 55923



Please provide tagging information as needed for your project.

Towers72

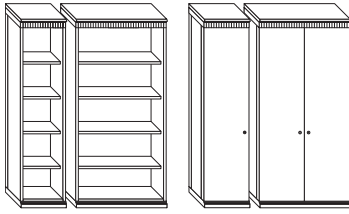

	w	15.9d	74.9h	Product No.	List \$
15 Deep Towers					Flush Ends/Back
• Tower 72/15: Shelving 18	18			69TAA00	7113
• Tower 72/15: DblShelving 36	36			69TAF00	10460
• Tower 72/15: Cabinet LH 18	18			69TBA10	7412
• Tower 72/15: Cabinet RH 18	18			69TBA20	7412
• Tower 72/15: DblCabinet 36	36			69TBF00	12065

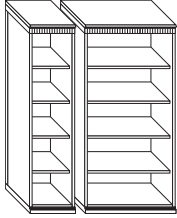

	w	24.9d	74.9h	Product No.	List \$
24 Deep Shelving					Flush Ends/Back
• Tower 72/24: Shelving 18	18			69TAA30	8609
• Tower 72/24: DblShelving 36	36			69TAF30	12440

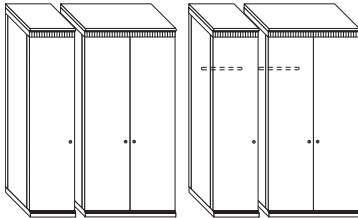

	w	24.9d	74.9h	Product No.	List \$
24 Deep Cabinets					Flush Ends/Back
• Tower 72/24: Cabinet LH 18	18			69TBA40	9018
• Tower 72/24: Cabinet RH 18	18			69TBA50	9018
• Tower 72/24: DblCabinet 36	36			69TBF30	14656
• Tower 72/24: Garment LH 18	18			69TCA40	8424
• Tower 72/24: Garment RH 18	18			69TCA50	8424
• Tower 72/24: Garment:Cab 36	36			69TCF40	14051
• Tower 72/24: Cab:Garment 36	36			69TCF50	14051

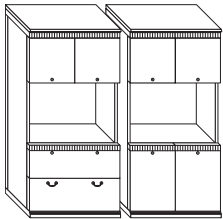

	w	24.9d	74.9h	Product No.	List \$
24 Deep Shelving					Flush Ends/Back
• Tower 72/24: Cab/Shlv/LatF 36	36			69THF30	15328
• Tower 72/24: Cab/Shlv/Cab 36	36			69TJF30	14918

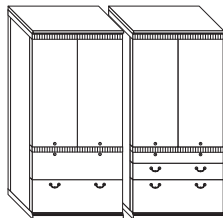

	w	24.9d	74.9h	Product No.	List \$
24 Deep Cabinet/Drawers					Flush Ends/Back
• Tower 72/24: Cab/LatF 36	36			69TEF30	15959
• Tower 72/24: Cab/LatB/LatF 36	36			69TFF30	16422

§

Add 1.7 to width

Units with glass doors include glass shelves and low voltage LED lights.

Towers85

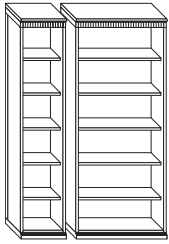

	w	15.9d	87.5h	Product No.	List \$
15 Deep Shelving				Flush Ends/Back	
• Tower 85/15: Shelving 18	18			69UAA00	7857
• Tower 85/15: DblShelving 36	36			69UAF00	10828

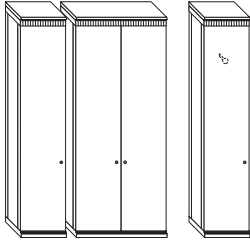

	w	15.9d	87.5h	Product No.	List \$
15 Deep Cabinets				Flush Ends/Back	
• Tower 85/15: Cabinet LH 18	18			69UBA10	8458
• Tower 85/15: Cabinet RH 18	18			69UBA20	8458
• Tower 85/15: DblCabinet 36	36			69UBF00	12440
• Tower 85/15: Garment LH 18	18			69UCA10	8165
• Tower 85/15: Garment RH 18	18			69UCA20	8165

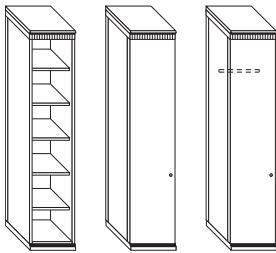

	18w	24.9d	87.5h	Product No.	List \$
24 Deep Towers				Flush Ends/Back	
• Tower 85/24: Shelving 18				69UAA30	9436
• Tower 85/24: Cabinet LH 18				69UBA40	10218
• Tower 85/24: Cabinet RH 18				69UBA50	10218
• Tower 85/24: Garment LH 18				69UCA40	9808
• Tower 85/24: Garment RH 18				69UCA50	9808

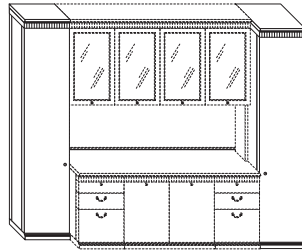

TUOHY

Specify: Product No.  
Quantity  
Tagging  
Wood Finish

Hardware Finish:  
712 Satin Black  
713 Low Lustre Brass

For quarter-sawn borders, specify  
Option BA, add 50%.

- Denotes Item is illustrated.
- ↪ Includes locks.

Available Species:  
**Cherry**  
**Mahogany**  
**Walnut**

Product No. List \$

Desk/Credenza Shells

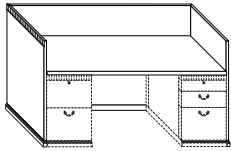

Desk/Credenza Shells	w	d	42h		
Gallery Desk/Cred: 66x24	68	25		69NGP03	9595
Gallery Desk/Cred: 66x30	68	31		69NGP05	10157
Gallery Desk/Cred: 72x24	74	25		69NGR03	9849
Gallery Desk/Cred: 72x30	74	31		69NGR05	10459
• Gallery Desk/Cred: 72x36	74	37		69NGR07	11128
Gallery Desk/Cred: 78x24	80	25		69NGT03	10110
Gallery Desk/Cred: 78x30	80	31		69NGT05	10669
Gallery Desk/Cred: 78x36	80	37		69NGT07	11351
Gallery Desk/Cred: 84x24	86	25		69NGV03	10290
Gallery Desk/Cred: 84x30	86	31		69NGV05	10875
Gallery Desk/Cred: 84x36	86	37		69NGV07	11568
Gallery Desk/Cred: 90x24	92	25		69NGW03	10650
Gallery Desk/Cred: 90x30	92	31		69NGW05	11159
Gallery Desk/Cred: 90x36	92	37		69NGW07	11856

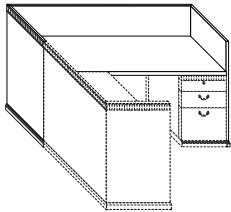

Desk/Credenza Shell for LH Attach	w	d	42h		
Gallery Desk/Cred: LH 66x24	68	25		69NGP13	10099
Gallery Desk/Cred: LH 66x30	68	31		69NGP15	10654
Gallery Desk/Cred: LH 72x24	74	25		69NGR13	10345
Gallery Desk/Cred: LH 72x30	74	31		69NGR15	10948
• Gallery Desk/Cred: LH 72x36	74	37		69NGR17	11259
Gallery Desk/Cred: LH 78x24	80	25		69NGT13	10604
Gallery Desk/Cred: LH 78x30	80	31		69NGT15	11163
Gallery Desk/Cred: LH 78x36	80	37		69NGT17	11846
Gallery Desk/Cred: LH 84x24	86	25		69NGV13	10781
Gallery Desk/Cred: LH 84x30	86	31		69NGV15	11373
Gallery Desk/Cred: LH 84x36	86	37		69NGV17	12065
Gallery Desk/Cred: LH 90x24	92	25		69NGW13	11149
Gallery Desk/Cred: LH 90x30	92	31		69NGW15	11654
Gallery Desk/Cred: LH 90x36	92	37		69NGW17	12355

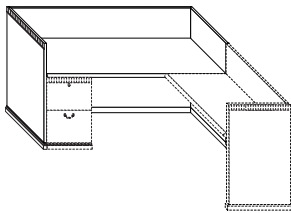

Desk/Credenza Shell for RH Attach	w	d	42h		
Gallery Desk/Cred: RH 66x24	68	25		69NGP23	10099
Gallery Desk/Cred: RH 66x30	68	31		69NGP25	10654
Gallery Desk/Cred: RH 72x24	74	25		69NGR23	10345
Gallery Desk/Cred: RH 72x30	74	31		69NGR25	10948
• Gallery Desk/Cred: RH 72x36	74	37		69NGR27	11259
Gallery Desk/Cred: RH 78x24	80	25		69NGT23	10604
Gallery Desk/Cred: RH 78x30	80	31		69NGT25	11163
Gallery Desk/Cred: RH 78x36	80	37		69NGT27	11846
Gallery Desk/Cred: RH 84x24	86	25		69NGV23	10781
Gallery Desk/Cred: RH 84x30	86	31		69NGV25	11373
Gallery Desk/Cred: RH 84x36	86	37		69NGV27	12065
Gallery Desk/Cred: RH 90x24	92	25		69NGW23	11149
Gallery Desk/Cred: RH 90x30	92	31		69NGW25	11654
Gallery Desk/Cred: RH 90x36	92	37		69NGW27	12355

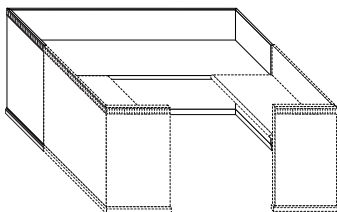

Desk/Credenza Shell for Dual Attach	w	d	42h		
Gallery Desk/Cred: Dual 84x30	86	31		69NGV35	11866
Gallery Desk/Cred: Dual 84x36	86	37		69NGV37	12556
Gallery Desk/Cred: Dual 90x30	92	31		69NGW35	12775
• Gallery Desk/Cred: Dual 90x36	92	37		69NGW37	12847

Product No. List \$

Runoff and Bridge Shells

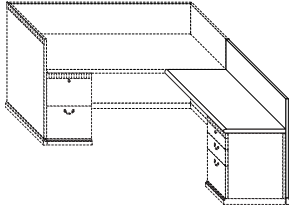

Runoff w. Open End: LH & RH Attach	w	d	42h		
Gallery Runoff: Open End LH 42	43	25		69NHH13	5795
Gallery Runoff: Open End LH 48	49	25		69NHJ13	6119
Gallery Runoff: Open End LH 54	55	25		69NHL13	6744
Gallery Runoff: Open End RH 42	43	25		69NHH23	5795
• Gallery Runoff: Open End RH 48	49	25		69NHJ23	6119
Gallery Runoff: Open End RH 54	55	25		69NHL23	6744

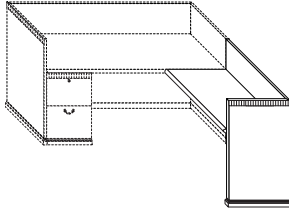

Runoff w. Panel End: LH & RH Attach	w	d	42h		
Gallery Runoff: Panel End LH 42	43	25		69NJH13	7366
Gallery Runoff: Panel End LH 48	49	25		69NJJ13	7691
Gallery Runoff: Panel End LH 54	55	25		69NJL13	8316
Gallery Runoff: Panel End RH 42	43	25		69NHJ23	7366
• Gallery Runoff: Panel End RH 48	49	25		69NJJ23	7691
Gallery Runoff: Panel End RH 54	55	25		69NJL23	8316

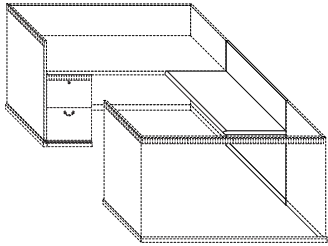

Bridge (Non-handed)	w	d	42h		
Gallery Bridge 42x18	42	18		69NKH01	6021
Gallery Bridge 48x18	48	18		69NKJ01	6202
Gallery Bridge 42x24	42	25		69NKH03	6120
• Gallery Bridge 48x24	48	25		69NKJ03	6306

Transaction Tops

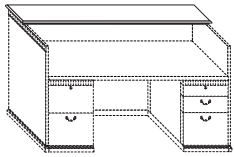

Transaction Top: Rectangular	w	13.7d	1.5th		
GalleryTop 66	68			69NTP03	2642
• GalleryTop 72	74			69NTR03	2707
GalleryTop 78	80			69NTS03	2753
GalleryTop 84	86			69NTV03	2787
GalleryTop 90	92			69NTW03	2981

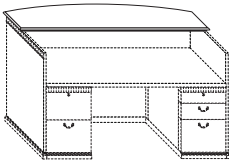

Transaction Top: D-Shape	w	19.7d	1.5th		
GalleryTop/D 66	68			69NTP33	3566
• GalleryTop/D 72	74			69NTR33	3636
GalleryTop/D 78	80			69NTS33	3689
GalleryTop/D 84	86			69NTV33	3730
GalleryTop/D 90	92			69NTW33	3915

Fabric Panels

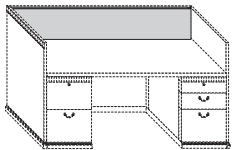

Fabric Panels	w	1 th	COM yd	12h (42 Panels)	
Gallery Fabric Pnl: 12	12		0.5	73NR0FF	488
Gallery Fabric Pnl: 18	18		0.6	73NRAFF	529
Gallery Fabric Pnl: 24	24		0.7	73NRCFF	574
Gallery Fabric Pnl: 30	30		1	73NRDFF	622
Gallery Fabric Pnl: 36	36		1.1	73NRRFF	671
Gallery Fabric Pnl: 42	42		1.3	73NRHFF	809
Gallery Fabric Pnl: 48	48		1.5	73NRJFF	950
Gallery Fabric Pnl: 54	54		1.6	73NRLFF	1088
Gallery Fabric Pnl: 60	60		1.7	73NRNFF	1114
Gallery Fabric Pnl: 66	66		2	73NRPFF	1139
• Gallery Fabric Pnl: 72	72		2.1	73NRRFF	1160
Gallery Fabric Pnl: 78	78		2.3	73NRTFF	1221
Gallery Fabric Pnl: 84	84		2.5	73NRVFF	1266
Gallery Fabric Pnl: 90	90		2.7	73NRWFF	1329

Shipping address for COM/COL materials and memo samples:  
TUOHY Furniture Corporation, P1 Upholstery Receiving, 42 Saint Albans Place, Chatfield, MN 55923



Please provide tagging information as needed for your project.

Specify: Product Number      • Denotes Item is illustrated.  
Quantity  
Tagging      For quarter-sawn borders, specify  
Wood Finish      Option BA, add 50%.

Available Species:  
**Cherry**  
**Mahogany**  
**Walnut**

