

TUOHY

Danza



Casegoods: **Danza**

Vertical Cadence	AD2
Drawer Layouts	AD3
Desk Shells	AD4
Desk Returns	AD6
Runoffs	AD8
Computer Corners	AD17
Wall Hung Credenza, AdjHt	AD19
Pedestals	AD21
Mobile Pedestals	AD23
Modesty Panels	AD24
Base Panels	AD25
Top Supports	AD25
Tops	AD26
Top Dividers	AD30
Hutches	AD31
Task Lights for Hutches	AD33
Wall Panels	AD34
Shelves	AD37
Towers Lateral Files	AD38
Towers 60.5	AD39
Towers 72.5h	AD42
Towers 84.5h	AD45

Vertical Cadence

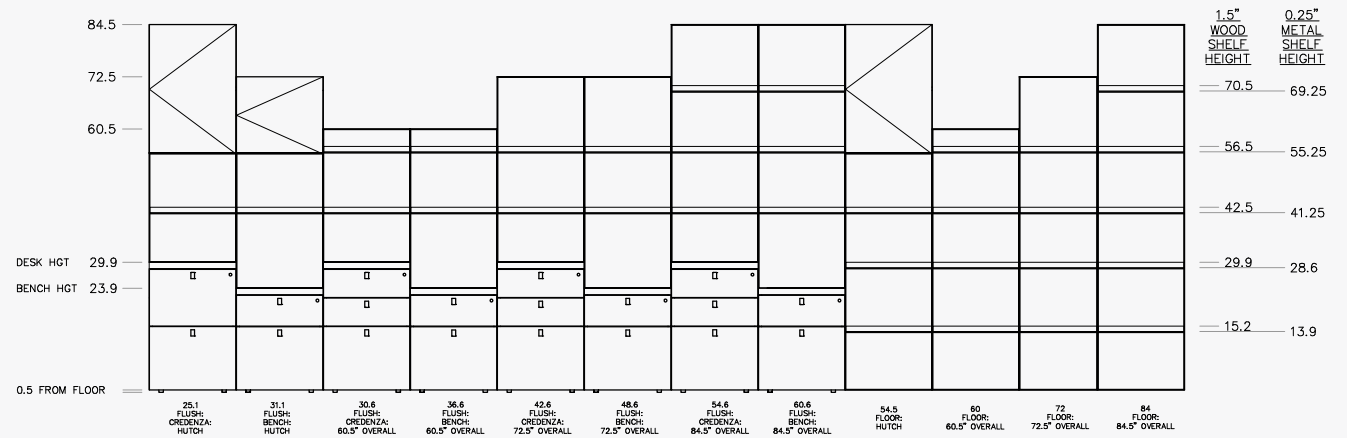

Drawer Layouts: Plan View

Slides: Under-Mount

Mobile 20d
Drawers 18d

16w 18w 24w

Pedestal Units 20d
Drawers 18d

16w 18w 20w 24w 30w 36w

Pedestal Units 24d
Drawers 21d

16w 18w 20w 24w 30w 36w

Peds 30d & 36d
Dwr 27d Dwr 15d

18w w-varies Ht.Adj.

Box Drawer w Divider

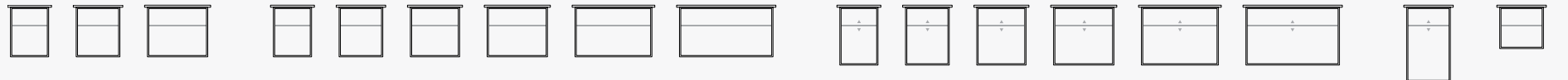

Lateral Filing

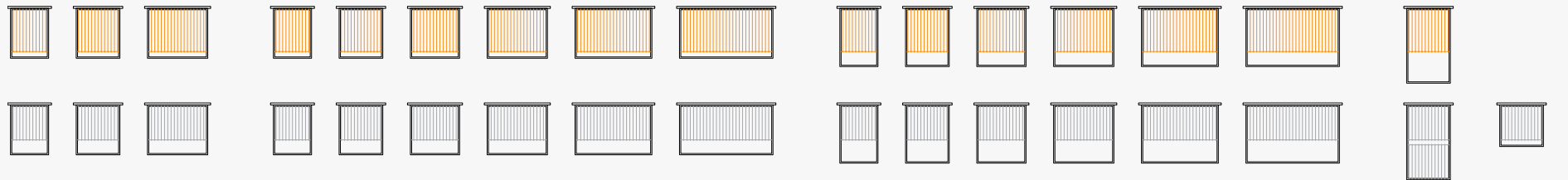

Front-to-Back Filing

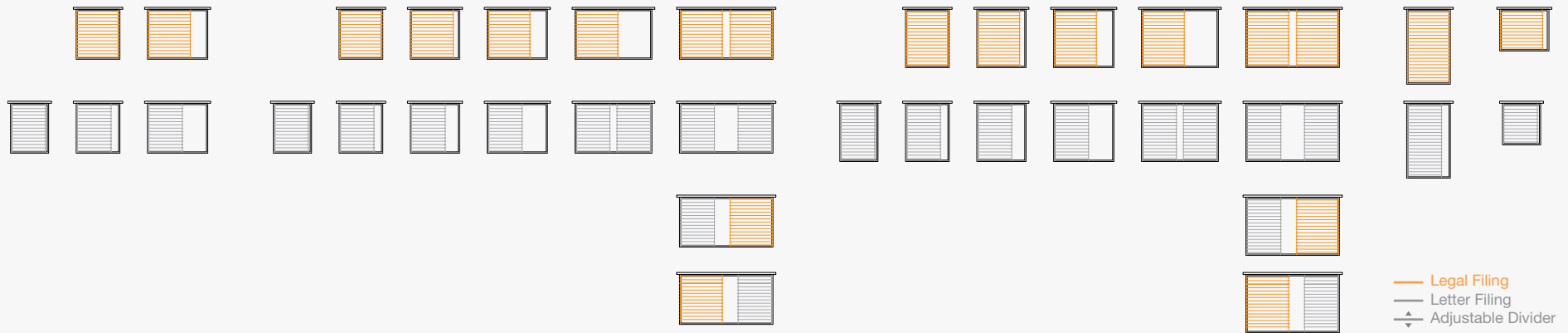

— Legal Filing
— Letter Filing
± Adjustable Divider

DRAWER CONSTRUCTION

A fine point for a quality casegood product is the inner drawer construction. Each TUOHY casegood offers you uncompromised excellence in this area as well. Drawer boxes are constructed with dovetail joinery for maximum durability. The drawer face is mounted separately to this box (i.e., five-sided construction) to maintain integrity.

Drawer bottoms are dadoed on all four sides. Slides for box drawers are rated at 100 pounds static load capacity; slides for file drawers are rated at a heavy duty 150 static load capacity. All slides are concealed, full extension and soft-close.

Box drawers have a removable divider, adjustable when depicted (±). File drawers have file frames for filing laterally or front-to-back, as depicted above. For Drawers for Lap Area, Drawer Pencil Tray, and Locks: See the Introduction/Terms-Options section of the Master Price List, page 12.

Desk Shell 29.9h

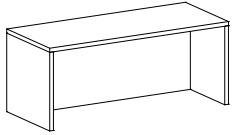
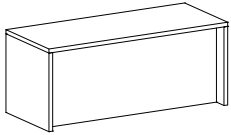

Description	Product No.	Spec Code	List \$	Spec Code	List \$	Spec Code	List \$	Spec Code	List \$
		HPL Top		Wood1 Top		Solid Surface Top		Matte BPGlass Top	
Desk 60w 30d	DZA?6030	HP	3010	W1	3317	SS	4297	AG	4790
Desk 60w 36d	DZA?6036	HP	3258	W1	3560	SS	4737	AG	5376
Desk 66w 30d	DZA?6630	HP	3124	W1	3432	SS	4508	AG	5076
Desk 66w 36d	DZA?6636	HP	3382	W1	3684	SS	4977	AG	5709
• Desk 72w 30d	DZA?7230	HP	3240	W1	3546	SS	4718	AG	5361
Desk 72w 36d	DZA?7236	HP	3509	W1	3807	SS	5213	AG	6036
Desk 78w 30d	DZA?7830	HP	3355	W1	3656	SS	4927	AG	5646
Desk 78w 36d	DZA?7836	HP	3635	W1	3931	SS	5456	AG	6367
Desk 84w 30d	DZA?8430	HP	3469	W1	3770	SS	5140	AG	5930
Desk 84w 36d	DZA?8436	HP	3761	W1	4054	SS	5695	AG	6697

! Notes:

- Top finishes are listed above; specify Wood1 finish for elements below worksurface.
- HPL is Formica 949 White, Matte.
- Solid Surface is Avonite® 8016 White, Matte.
- Matte BPGlass (Back-Painted) is Writable; specify (GMB) Black or (GMW) White.
- Glass tops have (MRBAS) Metal Resin Brushed Aluminum w/ Steel Tint edges; HPL tops have PVC edges; all other tops are self-edged.
- All desk pedestals are 18w wide.
- Pedestals are 24d on 30d shell.
- Pedestals are 30d on 36d shell.
- Modesty panel is set back 5.25 inches.
- Pull finish is (MRBAS) Brushed Aluminum w/Steel tint; for polished specify (MPA) Polished Aluminum.
- Locks included; for no locks, specify NL.

+ Options:

- For 30d Desk Shell:
 - For shell only, omit the ? in the 4th digit.
 - To add B/B/F left, append 4th digit from ? to A; and add \$2224.
 - To add B/B/F right, append 4th digit from ? to B; and add \$2224.
 - To add F/F left, append 4th digit from ? to C; and add \$2048.
 - To add F/F right, append 4th digit from ? to D; and add \$2048.
 - To add B/B/F left - F/F right, append 4th digit from ? to E; and add \$4275.
 - To add F/F left - B/B/F right, append 4th digit from ? to F; and add \$4275.
 - To add B/B/F left - B/B/F right, append 4th digit from ? to G; and add \$4447.
 - To add F/F left - F/F right append 4th digit from ? to H; and add \$4097.
- For 36d Desk Shell:
 - To add B/B/F left, append 4th digit from ? to A; and add \$2514.
 - To add B/B/F right, append 4th digit from ? to B; and add \$2514.
 - To add F/F left, append 4th digit from ? to C; and add \$2275.
 - To add F/F right, append 4th digit from ? to D; and add \$2275.
 - To add B/B/F left - F/F right, append 4th digit from ? to E; and add \$4790.
 - To add F/F left - B/B/F right, append 4th digit from ? to F; and add \$4790.
 - To add B/B/F left - B/B/F right, append 4th digit from ? to G; and add \$5025.
 - To add F/F left F/F right, append 4th digit from ? to H; and add \$4556.
 - To add metal edge to Wood, Laminate or Solid Surface tops append ME to end of Spec code; add price that correlates to top size from metal edge table below top options.

Desk Shell 29.9-48.4h
Adjustable Height

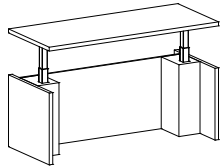
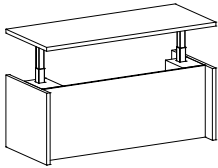

Description	Product No.	Spec Code	List \$	Spec Code	List \$	Spec Code	List \$	Spec Code	List \$
		HPL Top		Wood1 Top		Solid Surface Top		Matte BPGlass Top	
Desk 60w 30d	DZB?6030	HP	6113	W1	6423	SS	7404	AG	7894
Desk 60w 36d	DZB?6036	HP	6362	W1	6666	SS	7841	AG	8481
Desk 66w 30d	DZB?6630	HP	6231	W1	6536	SS	7613	AG	8178
Desk 66w 36d	DZB?6636	HP	6489	W1	6790	SS	8079	AG	8813
• Desk 72w 30d	DZB?7230	HP	6345	W1	6650	SS	7823	AG	8466
Desk 72w 36d	DZB?7236	HP	6615	W1	6915	SS	8320	AG	9143
Desk 78w 30d	DZB?7830	HP	6460	W1	6763	SS	8034	AG	8751
Desk 78w 36d	DZB?7836	HP	6741	W1	7036	SS	8560	AG	9471
Desk 84w 30d	DZB?8430	HP	6575	W1	6874	SS	8244	AG	9034
Desk 84w 36d	DZB?8436	HP	6867	W1	7160	SS	8800	AG	9802

! Notes:

Top finishes are listed above; specify Wood1 finish for elements below worksurface.

HPL is Formica 949 White, Matte.

Solid Surface is Avonite® 8016 White, Matte.

Matte BPGlass (Back-Painted) is Writable; specify (GMB) Black or (GMW) White.

Glass tops have (MRBAS) Metal Resin Brushed Aluminum w/ Steel Tint edges; HPL tops have PVC edges; all other tops are self-edged.

All desk pedestals are 18w wide.

Pedestals are 24d on 30d shell.

Pedestals are 30d on 36d shell.

Modesty panel is set back 5.25 inches.

Pull finish is (MRBAS) Brushed Aluminum w/Steel tint; for polished specify (MPA) Polished Aluminum.

Locks included; for no locks, specify NL.

+ Options:

For shell only, omit the ? in the 4th digit.

For 30d Desk Shell:

To add B/B/F left, append 4th digit from ? to A; and add \$2048.

To add B/B/F right, append 4th digit from ? to B; and add \$2048.

To add B/B/F left - B/B/F right, append 4th digit from ? to G; and add \$4274.

For 36d Desk Shell:

To add B/B/F left, append 4th digit from ? to A; and add \$2275.

To add B/B/F right, append 4th digit from ? to B; and add \$2275.

To add B/B/F left - B/B/F right, append 4th digit from ? to G; and add \$4790.

To add metal edge to Wood, Laminate or Solid Surface tops append ME to end of Spec code; add price that correlates to top size from metal edge table below top options.

Specify White, Silver, Black, Bronze, or Dark Bronze for height adjustable leg color.

Desk Return Shell 29.9h

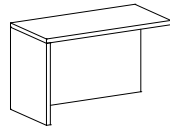
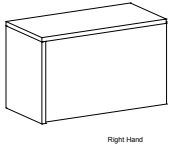

Description	Product No.	Spec Code	List \$	Spec Code	List \$	Spec Code	List \$	Spec Code	List \$
1.5 End Panel/Mod Panel		HPL Top		Wood1 Top		Solid Surface Top		Matte BPGlass Top	
• Return 48w 24d	DZC?4824	HP	2125	W1	2372	SS	2997	AG	3344
Return 54w 24d	DZC?5424	HP	2239	W1	2481	SS	3185	AG	3592
Return 60w 24d	DZC?6024	HP	2353	W1	2592	SS	3374	AG	3840

! Notes:

Top finishes are listed above; specify Wood1 finish for elements below worksurface.

HPL is Formica 949 White, Matte.

Solid Surface is Avonite® 8016 White, Matte.

Matte BPGlass (Back-Painted) is Writable; specify (GMB) Black or (GMW) White.

Glass tops have (MRBAS) Metal Resin Brushed Aluminum w/ Steel Tint edges; HPL tops have PVC edges; all other tops are self-edged.

All return pedestals are 18w x 20d.

Modesty panel is recessed 1.5-in.

Pull finish is (MRBAS) Brushed Aluminum w/Steel tint; for polished specify (MPA) Polished Aluminum.

Locks included; for no locks, specify NL.

+ Options:

For 24d Shell:

For shell only, omit the ? in the 4th digit.

To add B/B/F left, append 4th digit from ? to E; and add \$2224.

To add B/B/F right, append 4th digit from ? to F; and add \$2224.

To add F/F left, append 4th digit from ? to G; and add \$2048.

To add F/F right, append 4th digit from ? to H; and add \$2048.

Specify L, for left; or R, for right hand runoff. Place at the end of Product number.

To add metal edge to Wood, Laminate or Solid Surface tops append ME to end of Spec code; add price that correlates to top size from metal edge table below top options.

Desk Return Shell 29.9-48.4h
Height Adjustable

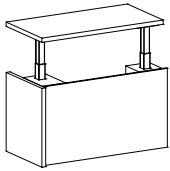

Right Hand

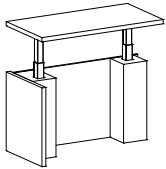

Left Hand

Description	Product No.	Spec Code	List \$	Spec Code	List \$	Spec Code	List \$	Spec Code	List \$
1.5 End Panel/Mod Panel		HPL Top		Wood1 Top		Solid Surface Top		Matte BPGlass Top	
• Runoff 48w 24d	DZD?4824	HP	5201	W1	5442	SS	6068	AG	6417
Runoff 54w 24d	DZD?5424	HP	5310	W1	5553	SS	6257	AG	6664
Runoff 60w 24d	DZD?6024	HP	5423	W1	5664	SS	6444	AG	6914

! Notes:

Top finishes are listed above; specify Wood1 finish for elements below worksurface.

HPL is Formica 949 White, Matte.

Solid Surface is Avonite® 8016 White, Matte.

Matte BPGlass (Back-Painted) is Writable; specify (GMB) Black or (GMW) White.

Glass tops have (MRBAS) Metal Resin Brushed Aluminum w/ Steel Tint edges; HPL tops have PVC edges; all other tops are self-edged.

Height adjustable legs will be inside plinths.

Mod Panel set back 1.5 inches.

Pull finish is (MRBAS) Brushed Aluminum w/Steel tint; for polished specify (MPA) Polished Aluminum.

Locks included; for no locks, specify NL.

+ Options:

Specify L for left, or R for right hand runoff. Place at the end of Product number.

To add metal edge to Wood, Laminate or Solid Surface tops append ME to end of Spec code; add price that correlates to top size from metal edge table below top options.

Specify White, Silver, Black, Bronze, or Dark Bronze for height adjustable leg color.

Runoff with Leg, 29.9h
Straight Leg

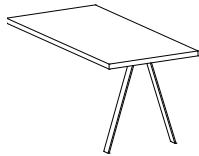

Runoff with Leg, 29.9h
Loop Leg

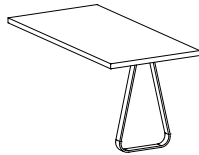

Description	Product No.	Spec Code	List \$	Spec Code	List \$	Spec Code	List \$	Spec Code	List \$
		HPL Top		Wood1 Top		Solid Surface Top		Matte BPGlass Top	
Runoff 48w 30d	DZES4830	HP	2276	W1	2712	SS	3839	AG	4306
Runoff 48w 36d	DZES4836	HP	2367	W1	2800	SS	4078	AG	4667
Runoff 54w 30d	DZES5430	HP	2333	W1	2769	SS	3989	AG	4534
Runoff 54w 36d	DZES5436	HP	2435	W1	2863	SS	4260	AG	4937
• Runoff 60w 30d	DZES6030	HP	2389	W1	2821	SS	4139	AG	4757
Runoff 60w 36d	DZES6036	HP	2501	W1	2926	SS	4440	AG	5207
Runoff 66w 30d	DZES6630	HP	2445	W1	2873	SS	4290	AG	4981
Runoff 66w 36d	DZES6636	HP	2567	W1	2990	SS	4622	AG	5476
Runoff 72w 30d	DZES7230	HP	2501	W1	2926	SS	4440	AG	5207
Runoff 72w 36d	DZES7236	HP	2636	W1	3054	SS	4803	AG	5748
		HPL Top		Wood1 Top		Solid Surface Top		Matte BPGlass Top	
Runoff 48w 30d	DZEC4830	HP	2432	W1	2868	SS	3992	AG	4458
Runoff 48w 36d	DZEC4836	HP	2520	W1	2953	SS	4234	AG	4821
Runoff 54w 30d	DZEC5430	HP	2485	W1	2920	SS	4141	AG	4683
Runoff 54w 36d	DZEC5436	HP	2586	W1	3016	SS	4414	AG	5089
• Runoff 60w 30d	DZEC6030	HP	2542	W1	2974	SS	4293	AG	4910
Runoff 60w 36d	DZEC6036	HP	2654	W1	3081	SS	4596	AG	5361
Runoff 66w 30d	DZEC6630	HP	2599	W1	3026	SS	4445	AG	5135
Runoff 66w 36d	DZEC6636	HP	2722	W1	3144	SS	4775	AG	5629
Runoff 72w 30d	DZEC7230	HP	2654	W1	3081	SS	4596	AG	5361
Runoff 72w 36d	DZEC7236	HP	2787	W1	3207	SS	4957	AG	5900

! Notes:

- Top finishes are listed above.
- HPL is Formica 949 White, Matte.
- Solid Surface is Avonite® 8016 White, Matte.
- Matte BPGlass (Back-Painted) is Writable; specify (GMB) Black or (GMW) White.
- Glass tops have (MRBAS) Metal Resin Brushed Aluminum w/ Steel Tint edges; HPL tops have PVC edges; all other tops are self-edged.

+ Options:

- Specify leg color from standard powder coat colors:
 - (MRB) Resin Black (MRSA) Resin Satin Aluminum
 - (MRBM) Resin Matte Black (MRTG) Resin Thunder Gray
 - (MRBZ) Resin Bronze (MRW) Resin White
 - (MRDBZ) Resin Dark Bronze
- Straight Leg; Polished Aluminum add \$1168, Brushed Aluminum w/Steel Tint add \$295.
- Continuous Loop; Polished Aluminum add \$1376, Brushed Aluminum w/Steel Tint add \$348.
- To add metal edge to Wood, Laminate or Solid Surface tops append ME to end of Spec code; add price that correlates to top size from metal edge table below top options.

Runoff, Short EndPnl & Mod 29.9h

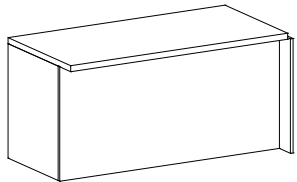

Right Hand

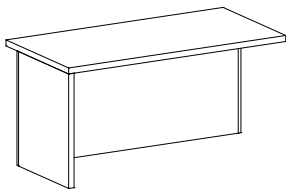

Left Hand

Description	Product No.	Spec Code	List \$	Spec Code	List \$	Spec Code	List \$	Spec Code	List \$
		HPL Top		Wood1 Top		Solid Surface Top		Matte BPGlass Top	
Runoff 48w 30d	DZEA4830	HP	2242	W1	2481	SS	3263	AG	3729
Runoff 48w 36d	DZEA4836	HP	2385	W1	2620	SS	3557	AG	4143
Runoff 54w 30d	DZEA5430	HP	2295	W1	2534	SS	3413	AG	3954
Runoff 54w 36d	DZEA5436	HP	2452	W1	2684	SS	3740	AG	4414
• Runoff 60w 30d	DZEA6030	HP	2354	W1	2586	SS	3565	AG	4182
Runoff 60w 36d	DZEA6036	HP	2518	W1	2747	SS	3919	AG	4683
Runoff 66w 30d	DZEA6630	HP	2409	W1	2640	SS	3714	AG	4405
Runoff 66w 36d	DZEA6636	HP	2585	W1	2809	SS	4100	AG	4955
Runoff 72w 30d	DZEA7230	HP	2464	W1	2693	SS	3866	AG	4632
Runoff 72w 36d	DZEA7236	HP	2651	W1	2873	SS	4282	AG	5226

! Notes:

Top finishes are listed above; specify Wood1 finish for elements below worksurface.

HPL is Formica 949 White, Matte.

Solid Surface is Avonite® 8016 White, Matte.

Matte BPGlass (Back-Painted) is Writable; specify (GMB) Black or (GMW) White.

Glass tops have (MRBAS) Metal Resin Brushed Aluminum w/ Steel Tint edges; HPL tops have PVC edges; all other tops are self-edged.

1.5-in End Panel.

Modesty panel is set back 5.25 inches.

+ Options:

Specify L, for left; or R, for right hand runoff. Place at the end of Product number.

To add metal edge to Wood, Laminate or Solid Surface tops append ME to end of Spec code; add price that correlates to top size from metal edge table below top options.

Runoff, EndPnl & Modesty 29.9h

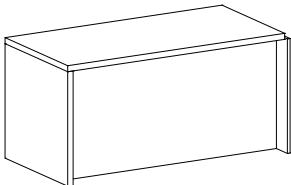

Right Hand

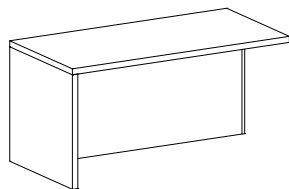

Left Hand

Description	Product No.	Spec Code	List \$	Spec Code	List \$	Spec Code	List \$	Spec Code	List \$
		HPL Top		Wood1 Top		Solid Surface Top		Matte BPGlass Top	
Runoff 48w 30d	DZEB4830	HP	2295	W1	2536	SS	3316	AG	3784
Runoff 48w 36d	DZEB4836	HP	2439	W1	2674	SS	3613	AG	4197
Runoff 54w 30d	DZEB5430	HP	2353	W1	2587	SS	3467	AG	4009
Runoff 54w 36d	DZEB5436	HP	2505	W1	2737	SS	3794	AG	4471
• Runoff 60w 30d	DZEB6030	HP	2407	W1	2641	SS	3617	AG	4235
Runoff 60w 36d	DZEB6036	HP	2574	W1	2801	SS	3974	AG	4740
Runoff 66w 30d	DZEB6630	HP	2463	W1	2693	SS	3770	AG	4459
Runoff 66w 36d	DZEB6636	HP	2640	W1	2865	SS	4157	AG	5010
Runoff 72w 30d	DZEB7230	HP	2518	W1	2747	SS	3919	AG	4683
Runoff 72w 36d	DZEB7236	HP	2706	W1	2927	SS	4335	AG	5279

! Notes:

Top finishes are listed above; specify Wood1 finish for elements below worksurface.

HPL is Formica 949 White, Matte.

Solid Surface is Avonite® 8016 White, Matte.

Matte BPGlass (Back-Painted) is Writable; specify (GMB) Black or (GMW) White.

Glass tops have (MRBAS) Metal Resin Brushed Aluminum w/ Steel Tint edges; HPL tops have PVC edges; all other tops are self-edged.

1.5-in End Panel.

Modesty panel is set back 5.25 inches.

+ Options:

Specify L, for left; or R, for right hand runoff. Place at the end of Product number.

To add metal edge to Wood, Laminate or Solid Surface tops append ME to end of Spec code; add price that correlates to top size from metal edge table below top options.

Runoff, Ped & Modesty 29.9h

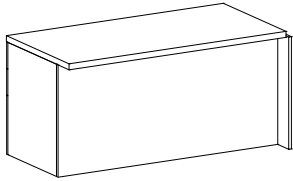

Right Hand

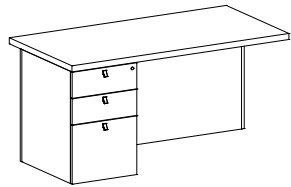

Left Hand

Description	Product No.	Spec Code	List \$	Spec Code	List \$	Spec Code	List \$	Spec Code	List \$
		HPL Top		Wood1 Top		Solid Surface Top		Matte BPGlass Top	
Runoff 48w 30d	DZF?4830	HP	1969	W1	2209	SS	2990	AG	3457
Runoff 48w 36d	DZF?4836	HP	2058	W1	2293	SS	3233	AG	3818
Runoff 54w 30d	DZF?5430	HP	2024	W1	2262	SS	3143	AG	3683
Runoff 54w 36d	DZF?5436	HP	2124	W1	2357	SS	3413	AG	4089
Runoff 60w 30d	DZF?6030	HP	2079	W1	2315	SS	3292	AG	3908
Runoff 60w 36d	DZF?6036	HP	2191	W1	2420	SS	3593	AG	4359
Runoff 66w 30d	DZF?6630	HP	2136	W1	2367	SS	3443	AG	4133
Runoff 66w 36d	DZF?6636	HP	2261	W1	2483	SS	3775	AG	4628
Runoff 72w 30d	DZF?7230	HP	2191	W1	2420	SS	3593	AG	4359
Runoff 72w 36d	DZF?7236	HP	2325	W1	2547	SS	3954	AG	4899

! Notes:

Top finishes are listed above; specify Wood1 finish for elements below worksurface.

HPL is Formica 949 White, Matte.

Solid Surface is Avonite® 8016 White, Matte.

Matte BPGlass (Back-Painted) is Writable; specify (GMB) Black or (GMW) White.

Glass tops have (MRBAS) Metal Resin Brushed Aluminum w/ Steel Tint edges; HPL tops have PVC edges; all other tops are self-edged.

All runoff pedestals are 18w.

Pedestals are 24d on 30d shell.

Pedestals are 30d on 36d shell.

Modesty panel is set back 5.25 inches.

Pull finish is (MRBAS) Brushed Aluminum w/Steel tint; for polished specify (MPA) Polished Aluminum.

Locks included; for no locks, specify NL.

+ Options:

For 30d Runoff Shell:

To add B/B/F left, append 4th digit to E and add \$2224.

To add B/B/F right, append 4th digit to F and add \$2224.

To add F/F left, append 4th digit to G and add \$2048.

To add F/F right, append 4th digit to H and add \$2048.

For 36d Runoff Shell:

To add B/B/F left, append 4th digit to E and add \$2514.

To add B/B/F right, append 4th digit to F and add \$2514.

To add F/F left, append 4th digit to G and add \$2275.

To add F/F right, append 4th digit to H and add \$2275.

To add metal edge to Wood, Laminate or Solid Surface tops append ME to end of Spec code; add price that correlates to top size from metal edge table below top options.

Description	Product No.	Spec Code	List \$	Spec Code	List \$	Spec Code	List \$	Spec Code	List \$	
Runoff Shell, Short End Pnl 29.9-48.4h Height Adjustable		HPL Top		Wood1 Top		Solid Surface Top		Matte BPGlass Top		
	Runoff 48w 30d	DZEE4830	HP	5389	W1	5628	SS	6411	AG	6876
	Runoff 48w 36d	DZEE4836	HP	5532	W1	5769	SS	6705	AG	7291
	Runoff 54w 30d	DZEE5430	HP	5443	W1	5682	SS	6560	AG	7103
	Runoff 54w 36d	DZEE5436	HP	5600	W1	5833	SS	6886	AG	7562
	Runoff 60w 30d	DZEE6030	HP	5502	W1	5734	SS	6712	AG	7328
	Runoff 60w 36d	DZEE6036	HP	5666	W1	5896	SS	7065	AG	7831
	Runoff 66w 30d	DZEE6630	HP	5557	W1	5787	SS	6862	AG	7553
	Runoff 66w 36d	DZEE6636	HP	5733	W1	5958	SS	7248	AG	8102
	Runoff 72w 30d	DZEE7230	HP	5612	W1	5841	SS	7014	AG	7779
Runoff 72w 36d	DZEE7236	HP	5800	W1	6023	SS	7430	AG	8375	

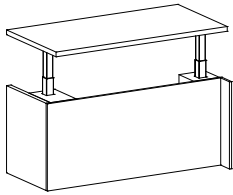

Right Hand

Description	Product No.	Spec Code	List \$	Spec Code	List \$	Spec Code	List \$	Spec Code	List \$	
Runoff Shell, End Pnl 29.9-48.4h Height Adjustable		HPL Top		Wood1 Top		Solid Surface Top		Matte BPGlass Top		
	Runoff 48w 30d	DZEF4830	HP	5443	W1	5683	SS	6464	AG	6931
	Runoff 48w 36d	DZEF4836	HP	5586	W1	5821	SS	6761	AG	7345
	Runoff 54w 30d	DZEF5430	HP	5500	W1	5736	SS	6615	AG	7157
	Runoff 54w 36d	DZEF5436	HP	5652	W1	5885	SS	6942	AG	7619
	• Runoff 60w 30d	DZEF6030	HP	5555	W1	5789	SS	6765	AG	7383
	Runoff 60w 36d	DZEF6036	HP	5720	W1	5949	SS	7122	AG	7888
	Runoff 66w 30d	DZEF6630	HP	5610	W1	5841	SS	6917	AG	7607
	Runoff 66w 36d	DZEF6636	HP	5787	W1	6013	SS	7303	AG	8157
	Runoff 72w 30d	DZEF7230	HP	5666	W1	5896	SS	7065	AG	7831
Runoff 72w 36d	DZEF7236	HP	5853	W1	6075	SS	7483	AG	8427	

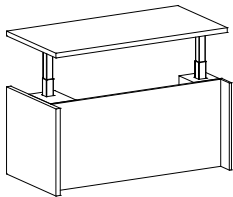

Right Hand

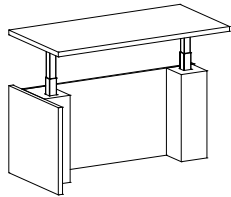

Left Hand

! Notes:

- Top finishes are listed above; specify Wood1 finish for elements below worksurface.
- HPL is Formica 949 White, Matte.
- Solid Surface is Avonite® 8016 White, Matte.
- Matte BPGlass (Back-Painted) is Writable; specify (GMB) Black or (GMW) White.
- Glass tops have (MRBAS) Metal Resin Brushed Aluminum w/ Steel Tint edges; HPL tops have PVC edges; all other tops are self-edged.
- Mitre folded plinth construction.
- 1.5-in End Panel.

+ Options:

- Specify L for left, or R for right hand runoff. Place at the end of product number.
- To add metal edge to Wood, Laminate or Solid Surface tops append ME to end of Spec code; add price that correlates to top size from metal edge table below top options.
- Specify White, Silver, Black, Bronze, or Dark Bronze for height adjustable leg color.

Runoff, Plinth-Mod-Plinth 29.9-48.4h
Height Adjustable

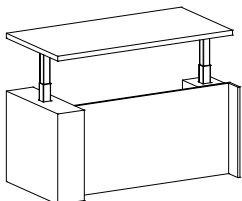

Description	Product No.	Spec Code	List \$	Spec Code	List \$	Spec Code	List \$	Spec Code	List \$
		HPL Top		Wood1 Top		Solid Surface Top		Matte BPGlass Top	
Runoff 48w 30d	DZEG4830	HP	5755	W1	5996	SS	6777	AG	7245
Runoff 48w 36d	DZEG4836	HP	5950	W1	6187	SS	7124	AG	7711
Runoff 54w 30d	DZEG5430	HP	5812	W1	6047	SS	6927	AG	7470
Runoff 54w 36d	DZEG5436	HP	6017	W1	6250	SS	7306	AG	7982
• Runoff 60w 30d	DZEG6030	HP	5866	W1	6102	SS	7079	AG	7692
Runoff 60w 36d	DZEG6036	HP	6087	W1	6314	SS	7488	AG	8251
Runoff 66w 30d	DZEG6630	HP	5921	W1	6154	SS	7229	AG	7918
Runoff 66w 36d	DZEG6636	HP	6153	W1	6376	SS	7668	AG	8520
Runoff 72w 30d	DZEG7230	HP	5978	W1	6206	SS	7380	AG	8145
Runoff 72w 36d	DZEG7236	HP	6219	W1	6441	SS	7849	AG	8793

! Notes:

Top finishes are listed above; specify Wood1 finish for elements below worksurface.

HPL is Formica 949 White, Matte.

Solid Surface is Avonite® 8016 White, Matte.

Matte BPGlass (Back-Painted) is Writable; specify (GMB) Black or (GMW) White.

Glass tops have (MRBAS) Metal Resin Brushed Aluminum w/ Steel Tint edges; HPL tops have PVC edges; all other tops are self-edged.

Mitre folded plinth construction.

+ Options:

Specify L, for left; or R, for right hand runoff. Place at the end of product number.

To add metal edge to Wood, Laminate or Solid Surface tops append ME to end of Spec code; add price that correlates to top size from metal edge table below top options.

Specify White, Silver, Black, Bronze, or Dark Bronze for height adjustable leg color.

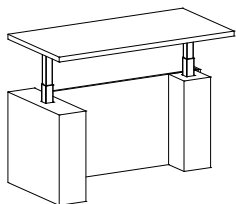

Runoff, Ped & Plinth 29.9-48.4h
Height Adjustable

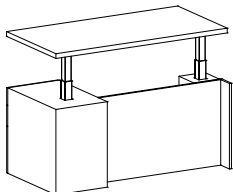

Right Hand

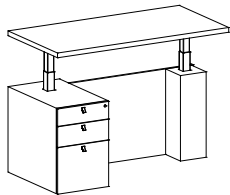

Left Hand

Description	Product No.	HPL Top		Wood1 Top		Solid Surface Top		Matte BPGlass Top	
		Spec Code	List \$	Spec Code	List \$	Spec Code	List \$	Spec Code	List \$
Runoff 48w 30d	DZG?4830	HP	6542	W1	6779	SS	7562	AG	6563
Runoff 48w 36d	DZG?4836	HP	6985	W1	7219	SS	8157	AG	6985
Runoff 54w 30d	DZG?5430	HP	6597	W1	6834	SS	7712	AG	6617
Runoff 54w 36d	DZG?5436	HP	7051	W1	7282	SS	8337	AG	7051
Runoff 60w 30d	DZG?6030	HP	6653	W1	6886	SS	7865	AG	6674
Runoff 60w 36d	DZG?6036	HP	7118	W1	7345	SS	8519	AG	7117
Runoff 66w 30d	DZG?6630	HP	6707	W1	6939	SS	8014	AG	6731
Runoff 66w 36d	DZG?6636	HP	7184	W1	7410	SS	8701	AG	7183
Runoff 72w 30d	DZG?7230	HP	6764	W1	6993	SS	8166	AG	6785
Runoff 72w 36d	DZG?7236	HP	7251	W1	7474	SS	8883	AG	7249

! Notes:

Top finishes are listed above; specify Wood1 finish for elements below worksurface.

HPL is Formica 949 White, Matte.

Solid Surface is Avonite® 8016 White, Matte.

Matte BPGlass (Back-Painted) is Writable; specify (GMB) Black or (GMW) White.

Glass tops have (MRBAS) Metal Resin Brushed Aluminum w/ Steel Tint edges; HPL tops have PVC edges; all other tops are self-edged.

All runoff pedestals are 18w 20d.

Mitre folded pedestal and plinth construction.

Pull finish is (MRBAS) Brushed Aluminum w/Steel tint; for polished specify (MPA) Polished Aluminum.

Locks included; for no locks, specify NL.

+ Options:

To add B/B/F left, append 4th digit to A and add \$2224.

To add B/B/F right, append 4th digit to B and add \$2224.

To add metal edge to Wood, Laminate or Solid Surface tops append ME to end of Spec code; add price that correlates to top size from metal edge table below top options.

Specify White, Silver, Black, Bronze, or Dark Bronze for height adjustable leg color.

Runoff, T-Leg 29.9-48.4h
Height Adjustable

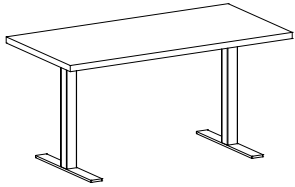

Description	Product No.	Spec Code	List \$	Spec Code	List \$	Spec Code	List \$	Spec Code	List \$
		HPL Top		Wood1 Top		Solid Surface Top		Matte BPGlass Top	
Runoff 48w 30d	DZEH4830	HP	4182	W1	4616	SS	5741	AG	6209
Runoff 48w 36d	DZEH4836	HP	4269	W1	4701	SS	5981	AG	6570
Runoff 54w 30d	DZEH5430	HP	4236	W1	4669	SS	5891	AG	6433
Runoff 54w 36d	DZEH5436	HP	4335	W1	4765	SS	6164	AG	6838
• Runoff 60w 30d	DZEH6030	HP	4292	W1	4724	SS	6042	AG	6660
Runoff 60w 36d	DZEH6036	HP	4404	W1	4829	SS	6345	AG	7109
Runoff 66w 30d	DZEH6630	HP	4347	W1	4776	SS	6194	AG	6883
Runoff 66w 36d	DZEH6636	HP	4471	W1	4892	SS	6524	AG	7379
Runoff 72w 30d	DZEH7230	HP	4404	W1	4829	SS	6345	AG	7109
Runoff 72w 36d	DZEH7236	HP	4537	W1	4957	SS	6705	AG	7649

! Notes:

Top finishes are listed above; specify Wood1 finish for elements below worksurface where applicable.

HPL is Formica 949 White, Matte.

Solid Surface is Avonite® 8016 White, Matte.

Matte BPGlass (Back-Painted) is Writable; specify (GMB) Black or (GMW) White.

Glass tops have (MRBAS) Metal Resin Brushed Aluminum w/ Steel Tint edges; HPL tops have PVC edges; all other tops are self-edged.

Plinth bases are mitre folded construction. Available on 3 leg desk only.

+ Options:

Specify L for left; or R for right hand runoff. Place at the end of product number.

To add metal edge to Wood, Laminate or Solid Surface tops append ME to end of Spec code; add price that correlates to top size from metal edge table below top options.

Specify White, Silver, Black, Bronze, or Dark Bronze for height adjustable leg color.

Runoff, Plinth 29.9-48.4h
Height Adjustable

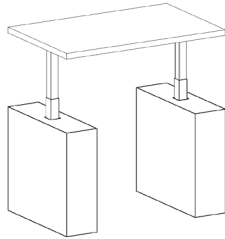
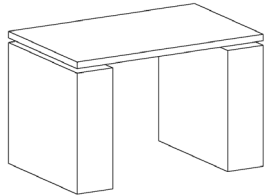

Description	Product No.	HPL Top		Wood1 Top		Solid Surface Top		Matte BPGlass Top	
		Spec Code	List \$	Spec Code	List \$	Spec Code	List \$	Spec Code	List \$
Runoff 48w 30d	DZEP4830	HP	6942	W1	7252	SS	8361	AG	9549
Runoff 48w 36d	DZEP4836	HP	7236	W1	7535	SS	8661	AG	9848
Runoff 54w 30d	DZEP5430	HP	7071	W1	7377	SS	8524	AG	9860
Runoff 54w 36d	DZEP5436	HP	7340	W1	7638	SS	8823	AG	10160
• Runoff 60w 30d	DZEP6030	HP	7175	W1	7480	SS	8686	AG	10170
Runoff 60w 36d	DZEP6036	HP	7442	W1	7736	SS	8974	AG	10459
Runoff 66w 30d	DZEP6630	HP	7279	W1	7578	SS	8838	AG	10471
Runoff 66w 36d	DZEP6636	HP	7368	W1	7840	SS	9131	AG	10765
Runoff 72w 30d	DZEP7230	HP	7383	W1	7680	SS	8995	AG	10775
Runoff 72w 36d	DZEP7236	HP	7702	W1	7943	SS	9300	AG	11081

! Notes:

Top finishes are listed above; specify Wood1 finish for elements below worksurface where applicable.

HPL is Formica 949 White, Matte.

Solid Surface is Avonite® 8016 White, Matte.

Matte BPGlass (Back-Painted) is Writable; specify (GMB) Black or (GMW) White.

Glass tops have (MRBAS) Metal Resin Brushed Aluminum w/ Steel Tint edges; HPL tops have PVC edges; all other tops are self-edged.

Plinth bases are mitre folded construction.

+ Options:

To add metal edge to Wood, Laminate or Solid Surface tops append ME to end of Spec code; add price that correlates to top size from metal edge table below top options. Specify White, Silver, Black, Bronze, or Dark Bronze for height adjustable leg color.

	Description	Product No.	Spec Code	List \$			Wood Modesty Option
				Wood1 Top	Solid Surface Top	Matte BPGlass Top	
Cantilevered Ht Adj Wall Hung Runoff 24-inch Deep Cabinet 29.9-44.9h Height Adjustable	Runoff 72w x 30d	DZEQ7230...	W	13641	SS 14775	G 17937	+338
	Runoff 72w x 36d	DZEQ7236...	W	13867	SS 15068	G 18576	+338
	Runoff 78w x 30d	DZEQ7830...	W	13688	SS 14845	G 18168	+369
	Runoff 78w x 36d	DZEQ7836...	W	13923	SS 15166	G 18850	+369

To add modesty append M to end of product number and add to list price. ↑

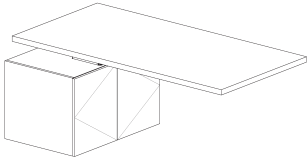

! Notes:

- Top finishes are listed above; specify Wood1 finish for elements below worksurface.
- Solid Surface is Avonite® 8016 White, Matte.
- Matte BPGlass (Back-Painted) is Writable; specify (GMB) Black or (GMW) White.
- Glass tops have (MRBAS) Metal Resin Brushed Aluminum w/ Steel Tint edges; HPL tops have PVC edges; all other tops are self-edged.
- Wall hung base unit is 24-inches deep and includes one ht adj column inside the shroud.
- Unit attaches to Wall.
- Order wall hung base unit top separately; can be ordered as an individual top or continuous top with adjacent pedestals.
- Support ladder frame is resin black.
- Optional Wood Modesty is 12-inches high.
- Unfinished back.
- No Locks.

+ Options:

- Specify shroud color from standard powder coat colors.
- (MRB) Resin Black (MRS) Resin Satin Aluminum
- (MRBM) Resin Matte Black (MRTG) Resin Thunder Gray
- (MRBZ) Resin Bronze (MRW) Resin White
- (MRDBZ) Resin Dark Bronze

Description	Product No.	Spec Code	List \$	Wood Modesty Option		
				Wood1 Top	Solid Surface Top	Matte BPGlass Top
Cantilevered Ht Adj Wall Hung Runoff 30-inch Deep Cabinet 29.9-44.9h Height Adjustable	Runoff 84w x 30d	DZER8430...	W 22894	SS 23993	G 27635	+357
	Runoff 84w x 36d	DZER8436...	W 23205	SS 24392	G 29091	+357
	Runoff 90w x 30d	DZER9030...	W 23044	SS 24077	G 28538	+381
	Runoff 90w x 36d	DZER9036...	W 23265	SS 24491	G 29364	+381

To add modesty append M to end of product number and add to list price. 

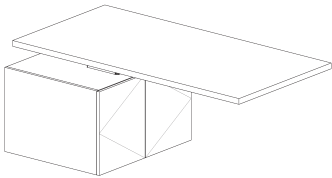

! Notes:

- Top finishes are listed above; specify Wood1 finish for elements below worksurface.
- Solid Surface is Avonite® 8016 White, Matte.
- Matte BPGlass (Back-Painted) is Writable; specify (GMB) Black or (GMW) White.
- Glass tops have (MRBAS) Metal Resin Brushed Aluminum w/ Steel Tint edges; HPL tops have PVC edges; all other tops are self-edged.
- Wall hung base unit is 30-inches deep and includes two ht adj columns inside the shroud.
- Unit attaches to Wall.
- Order wall hung base unit top separately; can be ordered as an individual top or continuous top with adjacent pedestals.
- Support ladder frame is resin black.
- Optional Wood Modesty is 12-inches high.
- Unfinished back.
- No Locks.

+ Options:

- Specify shroud color from standard powder coat colors.
- (MRB) Resin Black (MRSB) Resin Satin Aluminum
- (MRBM) Resin Matte Black (MRTG) Resin Thunder Gray
- (MRBZ) Resin Bronze (MRW) Resin White
- (MRDBZ) Resin Dark Bronze

Computer Corner, T Legs 29.9-48.4h
Height Adjustable

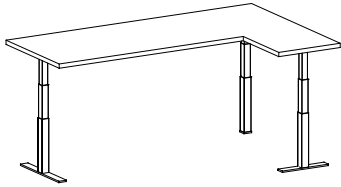

Description	Product No.	Spec Code	List \$	Spec Code	List \$
		HPL Top		Wood1 Top	
Corner 72w 30d x 48w 20d	DZEJ72304820	HP	5238	W1	5649
Corner 72w 36d x 48w 24d	DZEJ72364824	HP	5430	W1	5833
Corner 78w 30d x 48w 20d	DZEJ78304820	HP	5293	W1	5702
Corner 78w 36d x 48w 24d	DZEJ78364824	HP	5495	W1	5897
Corner 84w 30d x 48w 20d	DZEJ84304820	HP	5349	W1	5755
Corner 84w 36d x 48w 24d	DZEJ84364824	HP	5564	W1	5960
Corner 96w 30d x 48w 20d	DZEJ96304820	HP	5461	W1	5859
Corner 96w 36d x 48w 24d	DZEJ96364824	HP	5696	W1	6088
		HPL Top		Wood1 Top	
Corner 72w 30d x 54w 20d	DZEJ72305420	HP	5273	W1	5685
Corner 72w 36d x 54w 24d	DZEJ72365424	HP	5473	W1	5874
Corner 78w 30d x 54w 20d	DZEJ78305420	HP	5330	W1	5736
Corner 78w 36d x 54w 24d	DZEJ78365424	HP	5541	W1	5937
Corner 84w 30d x 54w 20d	DZEJ84305420	HP	5384	W1	5790
Corner 84w 36d x 54w 24d	DZEJ84365424	HP	5609	W1	6001
Corner 96w 30d x 54w 20d	DZEJ96305420	HP	5495	W1	5897
Corner 96w 36d x 54w 24d	DZEJ96365424	HP	5742	W1	6129
		HPL Top		Wood1 Top	
Corner 72w 30d x 60w 20d	DZEJ72306020	HP	5310	W1	5717
Corner 72w 36d x 60w 24d	DZEJ72366024	HP	5519	W1	5917
Corner 78w 30d x 60w 20d	DZEJ78306020	HP	5368	W1	5773
Corner 78w 36d x 60w 24d	DZEJ78366024	HP	5586	W1	5980
Corner 84w 30d x 60w 20d	DZEJ84306020	HP	5423	W1	5825
Corner 84w 36d x 60w 24d	DZEJ84366024	HP	5652	W1	6045
Corner 96w 30d x 60w 20d	DZEJ96306020	HP	5534	W1	5931
• Corner 96w 36d x 60w 24d	DZEJ96366024	HP	5787	W1	6172

! Notes:

Top finishes are listed above; specify Wood1 finish for elements below worksurface where applicable.
 HPL is Formica 949 White, Matte.
 Solid Surface is Avonite® 8016 White, Matte.
 Plinth bases are mitre folded construction. Available on 3 leg desk only.

+ Options:

Specify L for left; or R for right hand runoff. Place at the end of product number.
 Specify White, Silver, Black, Bronze, or Dark Bronze for height adjustable leg color.

Computer Corner, Plinth Bases 29.9-48.4h
Height Adjustable

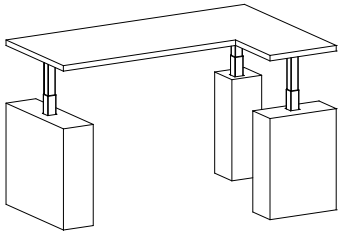

Description	Product No.	Spec Code	List \$	Spec Code	List \$
		HPL Top		Wood1 Top	
• Corner 72w 30d x 48w 20d	DZEK72304820	HP	7899	W1	8311
Corner 72w 36d x 48w 24d	DZEK72364824	HP	8092	W1	8492
Corner 78w 30d x 48w 20d	DZEK78304820	HP	7954	W1	8361
Corner 78w 36d x 48w 24d	DZEK78364824	HP	8157	W1	8556
Corner 84w 30d x 48w 20d	DZEK84304820	HP	8009	W1	8415
Corner 84w 36d x 48w 24d	DZEK84364824	HP	8225	W1	8619
Corner 96w 30d x 48w 20d	DZEK96304820	HP	8122	W1	8520
Corner 96w 36d x 48w 24d	DZEK96364824	HP	8359	W1	8749
		HPL Top		Wood1 Top	
Corner 72w 30d x 54w 20d	DZEK72305420	HP	7936	W1	8348
Corner 72w 36d x 54w 24d	DZEK72365424	HP	8134	W1	8537
Corner 78w 30d x 54w 20d	DZEK78305420	HP	7989	W1	8397
Corner 78w 36d x 54w 24d	DZEK78365424	HP	8203	W1	8600
Corner 84w 30d x 54w 20d	DZEK84305420	HP	8047	W1	8451
Corner 84w 36d x 54w 24d	DZEK84365424	HP	8270	W1	8663
Corner 96w 30d x 54w 20d	DZEK96305420	HP	8157	W1	8556
Corner 96w 36d x 54w 24d	DZEK96365424	HP	8402	W1	8792
		HPL Top		Wood1 Top	
Corner 72w 30d x 60w 20d	DZEK72306020	HP	7972	W1	8380
Corner 72w 36d x 60w 24d	DZEK72366024	HP	8178	W1	8579
Corner 78w 30d x 60w 20d	DZEK78306020	HP	8028	W1	8433
Corner 78w 36d x 60w 24d	DZEK78366024	HP	8248	W1	8642
Corner 84w 30d x 60w 20d	DZEK84306020	HP	8084	W1	8487
Corner 84w 36d x 60w 24d	DZEK84366024	HP	8315	W1	8706
Corner 96w 30d x 60w 20d	DZEK96306020	HP	8196	W1	8592
Corner 96w 36d x 60w 24d	DZEK96366024	HP	8448	W1	8834

! Notes:

Top finishes are listed above; specify Wood1 finish for elements below worksurface where applicable.

HPL is Formica 949 White, Matte.

Solid Surface is Avonite® 8016 White, Matte.

Plinth bases are mitre folded construction. Available on 3 leg desk only.

+ Options:

Specify L for left; or R for right hand runoff. Place at the end of product number.

Specify White, Silver, Black, Bronze, or Dark Bronze for height adjustable leg color.

L-Shaped Wall Hung Credenza w/ Wedge
24-inch Deep Wall Hung Unit
29.9-48.4h Height Adjustable

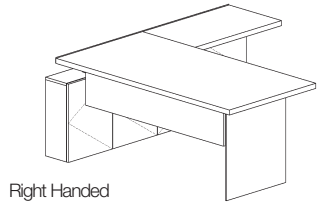

Right Handed

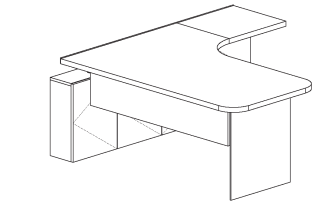
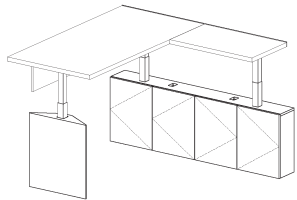

Right Handed
(shown with outer radius corner option)

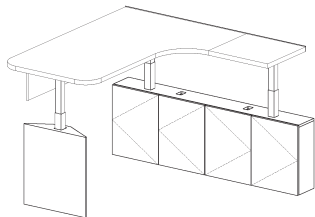

Description	Product No.	HPL Top		Wood Top		Solid Surface Top	
		Square Edge ...HPS	Bevel Edge ...HPB	Square Edge ...WS	Bevel Edge ...WB	Square Edge ...SSS	Bevel Edge ...SSB
Square Corner, 30d Desk							
Wall Hung L-Shape 72w 24d x 72w 30d	DZKA7272...	18753	—	18501	—	20417	—
Wall Hung L-Shape 78w 24d x 72w 30d	DZKA7872...	19184	—	18921	—	20900	—
Wall Hung L-Shape 84w 24d x 72w 30d	DZKA8472...	19621	—	19347	—	21391	—
Wall Hung L-Shape 90w 24d x 84w 30d	DZKA9084...	20416	—	20101	—	22368	—
Wall Hung L-Shape 96w 24d x 84w 30d	DZKA9684...	20854	—	20528	—	22859	—
Wall Hung L-Shape 102w 24d x 84w 30d	DZKA10284...	21291	—	20954	—	23349	—
Wall Hung L-Shape 108w 24d x 84w 30d	DZKA10884...	21729	—	21380	—	23838	—
Wall Hung L-Shape 120w 24d x 84w 30d	DZKA12084...	23210	—	22839	—	25425	—
Square Corner, 36d Desk							
• Wall Hung L-Shape 72w 24d x 72w 36d	DZKB7272...	18870	—	18594	—	20639	—
Wall Hung L-Shape 78w 24d x 72w 36d	DZKB7872...	19300	—	19014	—	21122	—
Wall Hung L-Shape 84w 24d x 72w 36d	DZKB8472...	19738	—	19441	—	21611	—
Wall Hung L-Shape 90w 24d x 84w 36d	DZKB9084...	20557	—	20214	—	22640	—
Wall Hung L-Shape 96w 24d x 84w 36d	DZKB9684...	20995	—	20640	—	23130	—
Wall Hung L-Shape 102w 24d x 84w 36d	DZKB10284...	21433	—	21066	—	23621	—
Wall Hung L-Shape 108w 24d x 84w 36d	DZKB10884...	21870	—	21492	—	24110	—
Wall Hung L-Shape 120w 24d x 84w 36d	DZKB12084...	23352	—	22951	—	25698	—
Radius Inner Corner, 30d Desk							
Wall Hung L-Shape 72w 24d x 72w 30d	DZKC7272...	18984	20209	18686	19911	20857	—
Wall Hung L-Shape 78w 24d x 72w 30d	DZKC7872...	19415	20657	19106	20348	21340	—
Wall Hung L-Shape 84w 24d x 72w 30d	DZKC8472...	19852	21112	19532	20793	21831	—
Wall Hung L-Shape 90w 24d x 84w 30d	DZKC9084...	20701	22011	20329	21639	22915	—
Wall Hung L-Shape 96w 24d x 84w 30d	DZKC9684...	21139	22467	20754	22084	23405	—
Wall Hung L-Shape 102w 24d x 84w 30d	DZKC10284...	21575	22923	21181	22528	23895	—
Wall Hung L-Shape 108w 24d x 84w 30d	DZKC10884...	22013	23378	21607	22972	24385	—
Wall Hung L-Shape 120w 24d x 84w 30d	DZKC12084...	22889	24272	22460	23843	25365	—
Radius Inner Corner, 36d Desk							
• Wall Hung L-Shape 72w 24d x 72w 36d	DZKD7272...	19096	20353	18776	20033	21075	—
Wall Hung L-Shape 78w 24d x 72w 36d	DZKD7872...	19527	20811	19195	20479	21558	—
Wall Hung L-Shape 84w 24d x 72w 36d	DZKD8472...	19965	21267	19621	20923	22048	—
Wall Hung L-Shape 90w 24d x 84w 36d	DZKD9084...	20843	22185	20442	21785	23188	—
Wall Hung L-Shape 96w 24d x 84w 36d	DZKD9684...	21280	22641	20869	22229	23679	—
Wall Hung L-Shape 102w 24d x 84w 36d	DZKD10284...	21718	23097	21295	22674	24168	—
Wall Hung L-Shape 108w 24d x 84w 36d	DZKD10884...	22156	23553	21721	23118	24658	—
Wall Hung L-Shape 120w 24d x 84w 36d	DZKD12084...	23031	24446	22574	23988	25639	—

! Notes:

- Top finishes are listed above; specify Wood1 finish for elements below worksurface.
- HPL is Formica 949 White, Matte.
- Solid Surface is Avonite® 8016 White, Matte.
- Outer radius corners are 6-inches, inner radius corners are 12-inches.
- Wall hung plinth is 9-inches deep. Unit attaches to wall.
- Wood modesty is 12-inches high.
- Radius inner corner is 12-inches.
- Unfinished back.
- Includes Pencil Catch.
- No locks.

+ Options:

- For 6-inch radius outer corners append R to end of product number and add \$539 to list price.
- Specify L for left; or R for right hand runoff. Place at the end of product number.
- Specify pencil catch finish from standard powdercoat colors or (MRBAS) Brushed Aluminum w/ Steel Tint.
- To add Power, add "PWR" to end of Item Number; Add \$307. Power includes, Duplex and USB-A+C, soft plug
- Specify White, Silver, Black, Bronze, or Dark Bronze for height adjustable leg color

Wallhung dimension is listed first.
(Example of DZKB7872R)

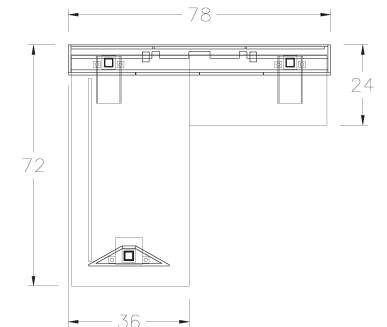

TUOHY

L-Shaped Wall Hung Credenza w/ Wedge
30-inch Deep Wall Hung Unit
29.9-48.4h Height Adjustable

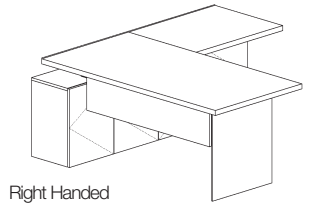

Right Handed

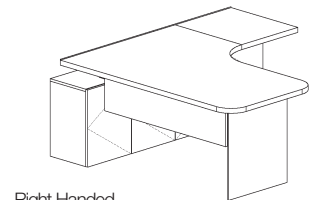
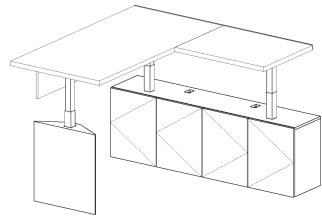

Right Handed
(shown with outer radius corner option)

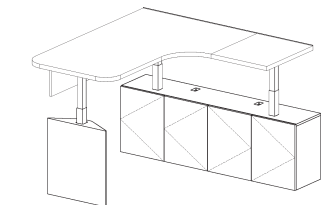

Description	Product No.	HPL Top		Wood Top		Solid Surface Top		
		Square Edge ...HPS	Bevel Edge ...HPB	Square Edge ...WS	Bevel Edge ...WB	Square Edge ...SSS	Bevel Edge ...SSB	
Square Corner, 30d Desk								
Wall Hung L-Shape 72w 30d x 72w 30d	DZKE7272...	19933	—	19682	—	21599	—	
Wall Hung L-Shape 78w 30d x 72w 30d	DZKE7872...	20413	—	20150	—	22130	—	
Wall Hung L-Shape 84w 30d x 72w 30d	DZKE8472...	20898	—	20623	—	22666	—	
Wall Hung L-Shape 90w 30d x 84w 30d	DZKE9084...	21739	—	21425	—	23691	—	
Wall Hung L-Shape 96w 30d x 84w 30d	DZKE9684...	22224	—	21899	—	24230	—	
Wall Hung L-Shape 102w 30d x 84w 30d	DZKE10284...	22709	—	22372	—	24766	—	
Wall Hung L-Shape 108w 30d x 84w 30d	DZKE10884...	23195	—	22846	—	25305	—	
Wall Hung L-Shape 120w 30d x 84w 30d	DZKE12084...	24771	—	24400	—	26986	—	
Square Corner, 36d Desk								
• Wall Hung L-Shape 72w 30d x 72w 36d	DZKF7272...	20050	—	19776	—	21819	—	
Wall Hung L-Shape 78w 30d x 72w 36d	DZKF7872...	20530	—	20243	—	22351	—	
Wall Hung L-Shape 84w 30d x 72w 36d	DZKF8472...	21015	—	20718	—	22888	—	
Wall Hung L-Shape 90w 30d x 84w 36d	DZKF9084...	21880	—	21538	—	23964	—	
Wall Hung L-Shape 96w 30d x 84w 36d	DZKF9684...	22365	—	22011	—	24502	—	
Wall Hung L-Shape 102w 30d x 84w 36d	DZKF10284...	22850	—	22485	—	25039	—	
Wall Hung L-Shape 108w 30d x 84w 36d	DZKF10884...	23335	—	22958	—	25577	—	
Wall Hung L-Shape 120w 30d x 84w 36d	DZKF12084...	24912	—	24512	—	27258	—	
Radius Inner Corner, 30d Desk								
Wall Hung L-Shape 72w 30d x 72w 30d	DZKG7272...	20163	21389	19867	21092	22037	—	
Wall Hung L-Shape 78w 30d x 72w 30d	DZKG7872...	20643	21886	20334	21578	22570	—	
Wall Hung L-Shape 84w 30d x 72w 30d	DZKG8472...	21128	22389	20808	22069	23107	—	
Wall Hung L-Shape 90w 30d x 84w 30d	DZKG9084...	22025	23335	21652	22962	24238	—	
Wall Hung L-Shape 96w 30d x 84w 30d	DZKG9684...	22510	23839	22126	23455	24777	—	
Wall Hung L-Shape 102w 30d x 84w 30d	DZKG10284...	22995	24342	22600	23947	25313	—	
Wall Hung L-Shape 108w 30d x 84w 30d	DZKG10884...	23480	24845	23073	24439	25851	—	
Wall Hung L-Shape 120w 30d x 84w 30d	DZKG12084...	25055	26439	24627	26010	27533	—	
Radius Inner Corner, 36d Desk								
• Wall Hung L-Shape 72w 30d x 72w 36d	DZKH7272...	20278	21533	19956	21213	22255	—	
Wall Hung L-Shape 78w 30d x 72w 36d	DZKH7872...	20755	22040	20425	21709	22787	—	
Wall Hung L-Shape 84w 30d x 72w 36d	DZKH8472...	21240	22542	20898	22200	23325	—	
Wall Hung L-Shape 90w 30d x 84w 36d	DZKH9084...	22167	23510	21765	23108	24512	—	
Wall Hung L-Shape 96w 30d x 84w 36d	DZKH9684...	22652	24012	22240	23600	25049	—	
Wall Hung L-Shape 102w 30d x 84w 36d	DZKH10284...	23137	24515	22714	24092	25586	—	
Wall Hung L-Shape 108w 30d x 84w 36d	DZKH10884...	23622	25019	23187	24584	26125	—	
Wall Hung L-Shape 120w 30d x 84w 36d	DZKH12084...	25199	26613	24740	26154	27806	—	

! Notes:

- Top finishes are listed above; specify Wood1 finish for elements below worksurface.
- HPL is Formica 949 White, Matte.
- Solid Surface is Avonite® 8016 White, Matte.
- Outer radius corners are 6-inches, inner radius corners are 12-inches.
- Wall hung plinth is 9-inches deep. Unit attaches to wall.
- Wood modesty is 12-inches high.
- Radius inner corner is 12-inches.
- Unfinished back.
- Includes pencil catch.
- No locks.

+ Options:

- For 6-inch radius outer corners append R to end of product number and add \$539 to list price.
- Specify L for left; or R for right hand runoff. Place at the end of product number.
- Specify pencil catch finish from standard powdercoat colors listed below or (MRBAS) Brushed Aluminum w/ Steel Tint.
- To add Power, add "PWR" to end of Item Number; Add \$307. Power includes, Duplex and USB-A+C, soft plug
- Specify White, Silver, Black, Bronze, or Dark Bronze for height adjustable leg color

Wallhung dimension is listed first.
(Example of DZKF7872R)

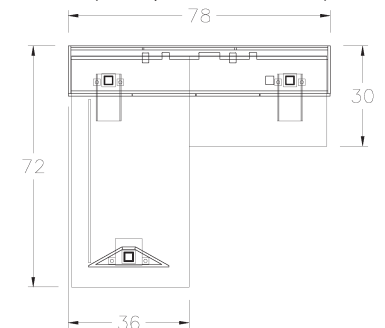

TUOHY

L-Shaped Desk w/ Wedge
30-inch Deep Runoff
29.9-48.4h Height Adjustable

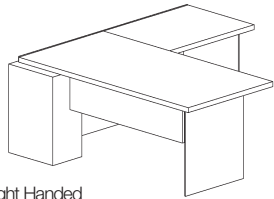

Right Handed

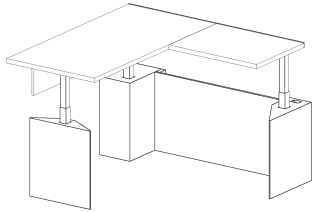

Right Handed
(shown with outer radius corner option)

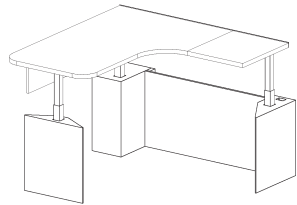

Description	Product No.	HPL Top		Wood Top		Solid Surface Top	
		Square Edge ...HPS	Bevel Edge ...HPB	Square Edge ...WS	Bevel Edge ...WB	Square Edge ...SSS	Bevel Edge ...SSB
Square Corner, 30d Desk							
L-Shaped Desk 72w 30d x 72w 30d	DZKJ7272...	14636	—	14350	—	16457	—
L-Shaped Desk 78w 30d x 72w 30d	DZKJ7872...	14709	—	14410	—	16596	—
L-Shaped Desk 84w 30d x 72w 30d	DZKJ8472...	14783	—	14468	—	16736	—
L-Shaped Desk 90w 30d x 84w 30d	DZKJ9084...	15213	—	14856	—	17362	—
L-Shaped Desk 96w 30d x 84w 30d	DZKJ9684...	15287	—	14914	—	17501	—
Square Corner, 36d Desk							
• L-Shaped Desk 72w 30d x 72w 36d	DZKL7272...	14753	—	14444	—	16678	—
L-Shaped Desk 78w 30d x 72w 36d	DZKL7872...	14826	—	14504	—	16818	—
L-Shaped Desk 84w 30d x 72w 36d	DZKL8472...	14900	—	14561	—	16956	—
L-Shaped Desk 90w 30d x 84w 36d	DZKL9084...	15354	—	14969	—	17635	—
L-Shaped Desk 96w 30d x 84w 36d	DZKL9684...	15429	—	15028	—	17773	—
Radius Inner Corner, 30d Desk							
L-Shaped Desk 72w 30d x 72w 30d	DZKM7272...	14902	16126	14535	15761	17089	—
L-Shaped Desk 78w 30d x 72w 30d	DZKM7872...	14977	16220	14594	15837	17244	—
L-Shaped Desk 84w 30d x 72w 30d	DZKM8472...	15054	16315	14654	15915	17399	—
L-Shaped Desk 90w 30d x 84w 30d	DZKM9084...	15541	16851	15083	16395	18148	—
L-Shaped Desk 96w 30d x 84w 30d	DZKM9684...	15617	16946	15143	16471	18304	—
Radius Inner Corner, 36d Desk							
• L-Shaped Desk 72w 30d x 72w 36d	DZKN7272...	15014	16271	14624	15881	17307	—
L-Shaped Desk 78w 30d x 72w 36d	DZKN7872...	15090	16374	14684	15968	17462	—
L-Shaped Desk 84w 30d x 72w 36d	DZKN8472...	15167	16469	14744	16045	17617	—
L-Shaped Desk 90w 30d x 84w 36d	DZKN9084...	15683	17026	15197	16540	18421	—
L-Shaped Desk 96w 30d x 84w 36d	DZKN9684...	15759	17120	15257	16617	18576	—

! Notes:

Top finishes are listed above; specify Wood1 finish for elements below worksurface.

HPL is Formica 949 White, Matte.

Solid Surface is Avonite® 8016 White, Matte.

Corner plinth is miterfolded.

Wood modesty is 12-inches high.

Radius inner corner is 12-inches.

Includes removable modesty panel and pencil catch.

Unfinished back.

No locks.

+ Options:

For 6-inch radius outer corners append R to end of product number and add \$539 to list price.

Specify L for left; or R for right hand runoff. Place at the end of product number.

Specify pencil catch finish from standard powdercoat colors or (MRBAS) Brushed Aluminum w/ Steel Tint.

Specify White, Silver, Black, Bronze, or Dark Bronze for height adjustable leg color

Wall side dimension is listed first.
(Example of DZKL7872R)

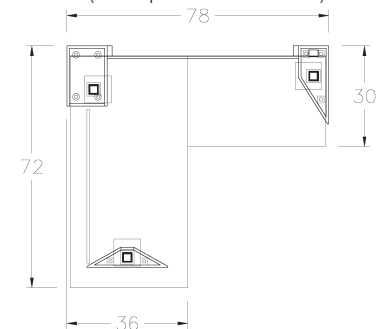

Wall Hung Credenza 29.9-48.4h
 Height Adjustable
 Veneer Interior

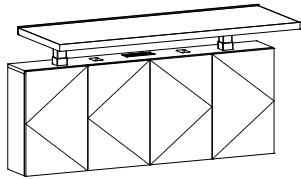

Description	Spec Code	List \$	Spec Code	List \$	Spec Code	List \$	Spec Code	List \$
	HPL Top		Wood1 Top		Solid Surface Top		Matte BPGlass Top	
Wall Hung 48w 24d	DZFA4824	HP 9346	W1 9788	SS 10634	AG 12128			
Wall Hung 48w 30d	DZFA4830	HP 9436	W1 9872	SS 10877	AG 12573			
Wall Hung 54w 24d	DZFA5424	HP 9750	W1 10191	SS 11116	AG 12753			
Wall Hung 54w 30d	DZFA5430	HP 9850	W1 10289	SS 11387	AG 13244			
• Wall Hung 60w 24d	DZFA6024	HP 10186	W1 10622	SS 11626	AG 13410			
Wall Hung 60w 30d	DZFA6030	HP 10297	W1 10730	SS 11926	AG 13945			
Wall Hung 66w 24d	DZFA6624	HP 10577	W1 11012	SS 12093	AG 14021			
Wall Hung 66w 30d	DZFA6630	HP 10701	W1 11128	SS 12424	AG 14600			
Wall Hung 72w 24d	DZFA7224	HP 10981	W1 11414	SS 12573	AG 14645			
Wall Hung 72w 30d	DZFA7230	HP 11114	W1 11538	SS 12937	AG 15272			
Wall Hung 78w 24d	DZFA7824	HP 11374	W1 11803	SS 13039	AG 15258			
Wall Hung 78w 30d	DZFA7830	HP 11519	W1 11943	SS 13433	AG 15926			

! Notes:

- Top finishes are listed above; specify Wood1 finish for elements below worksurface where applicable.
- HPL is Formica 949 White, Matte.
- Solid Surface is Avonite® 8016 White, Matte.
- Matte BPGlass (Back-Painted) is Writable; specify (GMB) Black or (GMW) White.
- Glass tops have (MRBAS) Metal Resin Brushed Aluminum w/ Steel Tint edges; HPL tops have PVC edges; all other tops are self-edged.
- All units have a 9d base section with vertical hinge door access.
- All units must be attached to wall.
- Accessory power: Dean Z mount ELDZ321SBLK 3-port (2) Simplex (1) USB A+C, soft plug, black.
- Includes Pencil Catch in (MRBAS) Brushed Aluminum w/ Steel Tint.
- No locks.

+ Options:

- To add metal edge to Wood, Laminate or Solid Surface tops, add ME to the end of Spec code, and price that correlates to top size from metal edge table.
- Specify White, Silver, Black, Bronze, or Dark Bronze for height adjustable leg color.

Wall Hung Credenza 29.9-48.4h
 Height Adjustable
 Cabinet Grade Interior

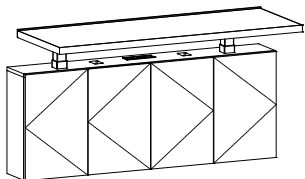

Description	Spec Code	List \$	Spec Code	List \$	Spec Code	List \$	Spec Code	List \$	
	HPL Top		Wood1 Top		Solid Surface Top		Matte BPGlass Top		
Wall Hung 48w 24d	DZfZ4824	HP	5856	W1	6155	SS	7275	AG	8464
Wall Hung 48w 30d	DZfZ4830	HP	5946	W1	6238	SS	7518	AG	8909
Wall Hung 54w 24d	DZfZ5424	HP	6109	W1	6409	SS	7562	AG	8898
Wall Hung 54w 30d	DZfZ5430	HP	6209	W1	6506	SS	7833	AG	9387
• Wall Hung 60w 24d	DZfZ6024	HP	6330	W1	6631	SS	7844	AG	9327
Wall Hung 60w 30d	DZfZ6030	HP	6442	W1	6739	SS	8143	AG	9863
Wall Hung 66w 24d	DZfZ6624	HP	6791	W1	6852	SS	8119	AG	9750
Wall Hung 66w 30d	DZfZ6630	HP	6916	W1	6967	SS	8449	AG	10331
Wall Hung 72w 24d	DZfZ7224	HP	6791	W1	7084	SS	8404	AG	10185
Wall Hung 72w 30d	DZfZ7230	HP	6925	W1	7210	SS	8769	AG	10811
Wall Hung 78w 24d	DZfZ7824	HP	7071	W1	7312	SS	8695	AG	10625
Wall Hung 78w 30d	DZfZ7830	HP	7216	W1	7451	SS	9089	AG	11294

! Notes:

Top finishes are listed above; specify Wood1 finish for elements below worksurface where applicable.
 HPL is Formica 949 White, Matte.
 Solid Surface is Avonite® 8016 White, Matte.
 Matte BPGlass (Back-Painted) is Writable; specify (GMB) Black or (GMW) White.
 Glass tops have (MRBAS) Metal Resin Brushed Aluminum w/ Steel Tint edges; HPL tops have PVC edges; all other tops are self-edged.
 All units have a 9d base section with vertical hinge door access.
 All units must be attached to wall.
 Includes Pencil Catch in (MRBAS) Brushed Aluminum w/ Steel Tint.
 No locks.

+ Options:

To add metal edge to Wood, Laminate or Solid Surface tops, add ME to the end of Spec code, and price that correlates to top size from metal edge table.
 Specify White, Silver, Black, Bronze, or Dark Bronze for height adjustable leg color.
 To add Power, add "PWR" to end of Item Number; Add \$307. Power includes, Duplex and USB-A+C, soft plug.

Pedestals 22.4h

Description	Prod.No.	List \$	Prod.No.	List \$		
Low Pedestals	DZFB	\$ sum	DZFC	\$ sum		
Low Pedestals w/ Toe Kick	DZFBTK	\$ sum	DZFCTK	\$ sum		
	Spec Code Wood1 Faces		Spec Code Wood1 Faces		Spec Code Finished Back	Add \$
		▲		▲		
Shelving 16w	A16	1542	A16	1605	FB	+83
• Shelving 18w	A18	1589	A18	1651	FB	+91
Shelving 20w	A20	1634	A20	1696	FB	+102
Shelving 24w	A24	1727	A24	1789	FB	+123
Shelving 30w	A30	1866	A30	1930	FB	+154
Shelving 36w	A36	2003	A36	2066	FB	+183
Cabinet 16w LH	CL16	2106	CL16	2170	FB	+83
Cabinet 16w RH	CR16	2106	CR16	2170	FB	+83
• Cabinet 18w LH	CL18	2168	CL18	2232	FB	+91
Cabinet 18w RH	CR18	2168	CR18	2232	FB	+91
Cabinet 20w LH	CL20	2230	CL20	2294	FB	+102
Cabinet 20w RH	CR20	2230	CR20	2294	FB	+102
Cabinet 24w DBL	C24	2400	C24	2463	FB	+123
Cabinet 30w DBL	C30	2561	C30	2647	FB	+154
Cabinet 36w DBL	C36	2771	C36	2834	FB	+183
Box/File 16w	R16	2329	R16	2439	FB	+83
• Box/File 18w	R18	2353	R18	2445	FB	+91
Box/File 20w	R20	2403	R20	2514	FB	+102
Box/File 24w	R24	2459	R24	2575	FB	+123
Box/File 30w	R30	2589	R30	2707	FB	+154
Box/File 36w	R36	2703	R36	2821	FB	+183
Open/File 16w	W16	2255	W16	2427	FB	+83
• Open/File 18w	W18	2289	W18	2449	FB	+91
Open/File 20w	W20	2334	W20	2517	FB	+102
Open/File 24w	W24	2406	W24	2601	FB	+123
Open/File 30w	W30	2541	W30	2757	FB	+154
Open/File 36w	W36	2659	W36	2890	FB	+183
Trash/Recycle 18w	T18	2244	T18	2380	FB	+91
Trash/Recycle 20w	T20	2321	T20	2417	FB	+102
Trash/Recycle 24w	T24	2393	T24	2517	FB	+123

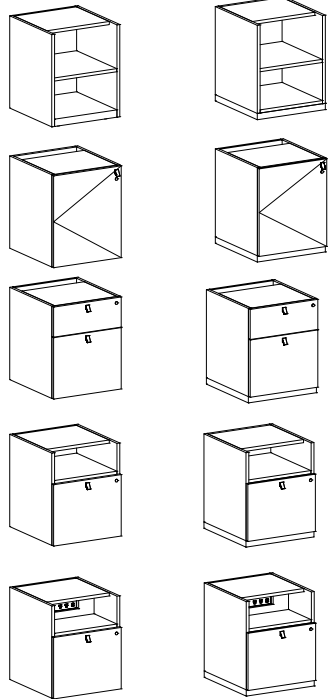

! Notes:

All pedestals have unfinished backs and are manufactured as combined units.
 Trash/Recycle units 18w x 20d and 20w x 20d contain (1) Trash/Recycle bin.
 Trash/Recycle units 24w x 20d and all units 24d contain (2) Trash/Recycle bins.
 Toe kick finish is (MRBAS) Brushed Aluminum w/Steel tint; for polished specify (MPA) Polished Aluminum.
 Pull finish is (MRBAS) Brushed Aluminum w/Steel tint; for polished specify (MPA) Polished Aluminum.
 Locks included; for no locks, specify NL.

+ Options:

To add finished back add FB and add dollar amount to total.
 For ventilation cutout add code VS to spec code, add \$506 to pedestal.
 To extend 20d pedestals ends for wire passage append X4 to end of the prefix code, add \$175; Extends outer end panels to 24d, inside panels remain at 20d.
 To add power to the Open/File pedestal append PWR to the spec code, add \$1252; Includes (1) 60w USB-C, (2) Simplex and (2) Standard USB charging.

Pedestals 28.4h

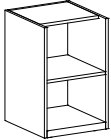
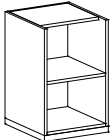
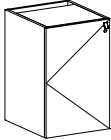
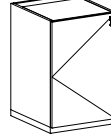
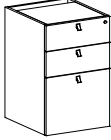
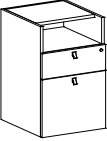
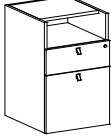
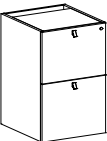
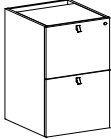
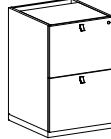
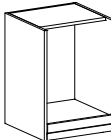
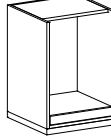
Description	Prod.No.	List \$	Prod.No.	List \$	Prod.No.	List \$	Prod.No.	List \$	Spec Code	Add \$		
	20d		24d		30d		36d		Wood1 Faces	Finished Back		
Pedestals	DZFD	\$ sum	DZFE	\$ sum	DZFF	\$ sum	DZFG	\$ sum				
Pedestals w/ Toe Kick	DZFDTK	\$ sum	DZFETK	\$ sum	DZFFTK	\$ sum	DZFGTK	\$ sum				
		Shelving 16w	A16	1641	A16	1720	—	—	—	—	FB	+102
		• Shelving 18w	A18	1689	A18	1769	—	—	—	—	FB	+116
		Shelving 20w	A20	1739	A20	1818	—	—	—	—	FB	+126
		Shelving 24w	A24	1836	A24	1915	—	—	—	—	FB	+154
		Shelving 30w	A30	1982	A30	2062	—	—	—	—	FB	+190
		Shelving 36w	A36	2130	A36	2209	—	—	—	—	FB	+228
		Cabinet 16w LH	CL16	2205	CL16	2287	—	—	—	—	FB	+102
		Cabinet 16w RH	CR16	2205	CR16	2287	—	—	—	—	FB	+102
		• Cabinet 18w LH	CL18	2270	CL18	2351	—	—	—	—	FB	+116
		Cabinet 18w RH	CR18	2270	CR18	2351	—	—	—	—	FB	+116
		Cabinet 20w LH	CL20	2337	CL20	2416	—	—	—	—	FB	+126
		Cabinet 20w RH	CR20	2337	CR20	2416	—	—	—	—	FB	+126
		Cabinet 24w LH	CL24	2464	CL24	2543	—	—	—	—	FB	+154
		Cabinet 24w RH	CR24	2464	CR24	2543	—	—	—	—	FB	+154
		Cabinet 30w DBL	C30	2678	C30	2783	—	—	—	—	FB	+190
		Cabinet 36w DBL	C36	2897	C36	2978	—	—	—	—	FB	+228
		2Box/File 16w	H16	2678	H16	2804	H16	3169	H16	3271	FB	+102
		• 2Box/File 18w	H18	2703	H18	2816	H18	3232	H18	3336	FB	+116
		2Box/File 20w	H20	2771	H20	2900	H20	3270	H20	3381	FB	+126
		2Box/File 24w	H24	2841	H24	2980	—	—	—	—	FB	+154
		2Box/File 30w	H30	3008	H30	3147	—	—	—	—	FB	+190
		2Box/File 36w	H36	3154	H36	3297	—	—	—	—	FB	+228
		Open/Box/File 16w	X16	2616	X16	2808	X16	3107	X16	3251	FB	+102
		• Open/Box/File 18w	X18	2649	X18	2832	X18	3173	X18	3324	FB	+116
		Open/Box/File 20w	X20	2712	X20	2920	X20	3221	X20	3376	FB	+126
		Open/Box/File 24w	X24	2798	X24	3023	—	—	—	—	FB	+154
		Open/Box/File 30w	X30	2969	X30	3213	—	—	—	—	FB	+190
		Open/Box/File 36w	X36	3123	X36	3382	—	—	—	—	FB	+228
		File/File 16w	K16	2477	K16	2651	K16	2865	K16	2969	FB	+102
		• File/File 18w	K18	2508	K18	2646	K18	2925	K18	3030	FB	+116
		File/File 20w	K20	2565	K20	2738	K20	2961	K20	3073	FB	+126
		File/File 24w	K24	2641	K24	2820	—	—	—	—	FB	+154
		File/File 30w	K30	2814	K30	2994	—	—	—	—	FB	+190
		File/File 36w	K36	2945	K36	3128	—	—	—	—	FB	+228
		Utility Tray 16w	U16	2255	U16	2342	—	—	—	—	FB	+102
		• Utility Tray 18w	U18	2283	U18	2372	—	—	—	—	FB	+116
		Utility Tray 20w	U20	2325	U20	2413	—	—	—	—	FB	+126
		Utility Tray 24w	U24	2386	U24	2477	—	—	—	—	FB	+154
		Utility Tray 30w	U30	2496	U30	2585	—	—	—	—	FB	+190
		Utility Tray 36w	U36	2602	U36	2693	—	—	—	—	FB	+228
		Trash/Recycle 18w	T18	2416	T18	2554	—	—	—	—	FB	+116
		Trash/Recycle 20w	T20	2450	T20	2587	—	—	—	—	FB	+126
		Trash/Recycle 24w	T24	2545	T24	2684	—	—	—	—	FB	+154

> See following page for Notes and Options.

Pedestals 28.4h (cont.)

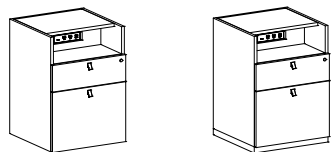

Description Product No. Spec Code List \$ Spec Code Add \$

! Notes (for product listing on prior page):
 All pedestals have unfinished backs and are manufactured as combined units.
 Trash/Recycle units 18w x 20d and 20w x 20d contain (1) Trash/Recycle bin.
 Trash/Recycle units 24w x 20d and all units 24d contain (2) Trash/Recycle bins.
 Toe kick finish is (MRBAS) Brushed Aluminum w/Steel tint; for polished specify (MPA) Polished Aluminum.
 Pull finish is (MRBAS) Brushed Aluminum w/Steel tint; for polished specify (MPA) Polished Aluminum.
 Locks included; for no locks, specify NL.

+ Options:
 To add finished back add FB and add dollar amount to total.
 For ventilation cutout add code VS to spec code, add \$506 to pedestal.
 To extend 20d pedestal ends for wire passage append X4 to end of the prefix code, add \$213; Extends outer end panels to 24d, inside panels remain at 20d.
 To extend 24d pedestal ends for wire passage append X6 to end of the prefix code, add \$320; Extends outer end panels to 30d, inside panels remain at 24d.
 To extend 30d pedestal ends for wire passage append X6 to end of the prefix code, add \$320; Extends outer end panels to 36d, inside panels remain at 30d.
 To add power to the Open/File pedestal append PWR to the spec code, add \$1252; Includes (1) 60w USB-C, (2) Simplex and (2) Standard USB charging.

Mobile Pedestals 21h

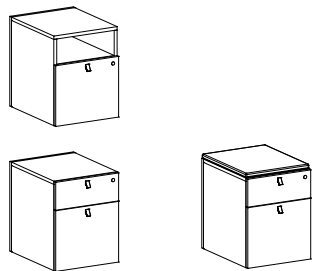

20d		Open/File		Box/File	
Mobile Ped 16w		DZFHF16	2255	DZFHBF16	2329
Mobile Ped 18w		DZFHF18	2289	DZFHBF18	2353
Mobile Ped 24w		DZFHF24	2334	DZFHBF24	2403

20d	COM yds	Open/File		Box/File	
Mobile Ped 16w w Cushion	1	DZFHF16C	2550	DZFHBF16C	2625
Mobile Ped 18w w Cushion	1	DZFHF18C	2583	DZFHBF18C	2645
Mobile Ped 24w w Cushion	1	DZFHF24C	2628	DZFHBF24C	2697

! Notes:
 Pull finish is (MRBAS) Brushed Aluminum w/Steel tint; for polished specify (MPA) Polished Aluminum.
 Locks included; for no locks, specify NL.
 Finished backs.

Modesty Panels

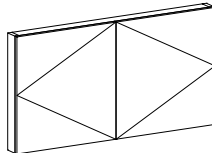
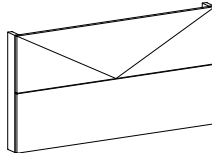
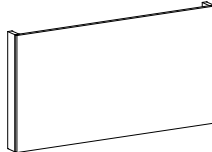
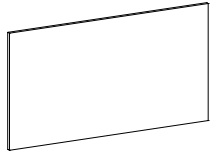

Description	Product No.	List \$	Product No.	List \$	Product No.	List \$	Product No.	List \$
22.4h	Fixed Finished Back 0.75d		Removable 3d		Horizontal Hinged 3d		Vertical Hinged 3d	
ModPanel: Low Credenza 16w	DZGFA-16	602	DZGRA-16	691	—	—	—	—
ModPanel: Low Credenza 18w	DZGFA-18	618	DZGRA-18	707	—	—	—	—
ModPanel: Low Credenza 20w	DZGFA-20	633	DZGRA-20	723	—	—	—	—
ModPanel: Low Credenza 24w	DZGFA-24	666	DZGRA-24	755	—	—	—	—
ModPanel: Low Credenza 30w	DZGFA-30	711	DZGRA-30	802	—	—	—	—
ModPanel: Low Credenza 36w	DZGFA-36	761	DZGRA-36	851	DZGHA-36	1265	DZGVA-36	1369
ModPanel: Low Credenza 42w	DZGFA-42	807	DZGRA-42	898	DZGHA-42	1313	DZGVA-42	1418
ModPanel: Low Credenza 48w	DZGFA-48	855	DZGRA-48	945	DZGHA-48	1361	DZGVA-48	1465
ModPanel: Low Credenza 54w	DZGFA-54	902	DZGRA-54	991	DZGHA-54	1408	DZGVA-54	1513
ModPanel: Low Credenza 60w	DZGFA-60	950	DZGRA-60	1233	DZGHA-60	1713	DZGVA-60	1805
ModPanel: Low Credenza 72w	DZGFA-72	996	DZGRA-72	1279	DZGHA-72	1759	DZGVA-72	1852
ModPanel: Low Credenza 84w	—	—	DZGRA-84	1328	DZGHA-84	1807	DZGVA-84	1901
ModPanel: Low Credenza 96w	—	—	DZGRA-96	1374	DZGHA-96	1853	DZGVA-96	1948
ModPanel: Low Credenza 108w	—	—	DZGRA-108	1426	DZGHA-108	1902	DZGVA-108	1996
ModPanel: Low Credenza 120w	—	—	DZGRA-120	1472	DZGHA-120	1949	DZGVA-120	2042
28.4	Fixed Finished Back 0.75d		Removable 3d		Horizontal Hinged 3d		Vertical Hinged 3d	
ModPanel: Credenza 16w	DZGFB-16	633	DZGRB-16	723	—	—	—	—
ModPanel: Credenza 18w	DZGFB-18	653	DZGRB-18	742	—	—	—	—
ModPanel: Credenza 20w	DZGFB-20	673	DZGRB-20	763	—	—	—	—
ModPanel: Credenza 24w	DZGFB-24	711	DZGRB-24	802	—	—	—	—
ModPanel: Credenza 30w	DZGFB-30	771	DZGRB-30	861	—	—	—	—
ModPanel: Credenza 36w	DZGFB-36	831	DZGRB-36	921	DZGHB-36	1337	DZGVB-36	1440
ModPanel: Credenza 42w	DZGFB-42	891	DZGRB-42	982	DZGHB-42	1395	DZGVB-42	1499
ModPanel: Credenza 48w	DZGFB-48	950	DZGRB-48	1041	DZGHB-48	1455	DZGVB-48	1559
ModPanel: Credenza 54w	DZGFB-54	1011	DZGRB-54	1101	DZGHB-54	1514	DZGVB-54	1618
ModPanel: Credenza 60w	DZGFB-60	1070	DZGRB-60	1393	DZGHB-60	1872	DZGVB-60	1966
ModPanel: Credenza 72w	DZGFB-72	1129	DZGRB-72	1453	DZGHB-72	1931	DZGVB-72	2024
ModPanel: Credenza 84w	—	—	DZGRB-84	1513	DZGHB-84	1992	DZGVB-84	2084
ModPanel: Credenza 96w	—	—	DZGRB-96	1571	DZGHB-96	2052	DZGVB-96	2143
ModPanel: Credenza 108w	—	—	DZGRB-108	1630	DZGHB-108	2111	DZGVB-108	2202
ModPanel: Credenza 120w	—	—	DZGRB-120	1691	DZGHB-120	2168	DZGVB-120	2263

! Notes:

Panels over 54 inches come with T panel included.

Parametric pricing, use price of panel just larger than size needed, Replace dimension on Product number with actual dimension.

+ Options (for all except Fixed Finished Back panels):

For finished end left, add L to the product number.

Ex. For 16w 22.4h Removable ModPanel with finished end left, product number is DZGRA-16L

For finished end right, add R to the product number.

For finished both ends, add B to the product number.

Base Panels

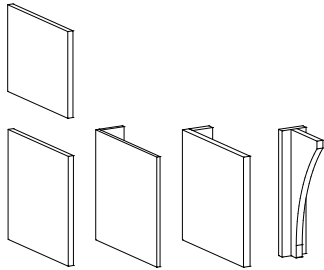

Description	Product No.	List \$	Product No.	List \$	Product No.	List \$	Product No.	List \$
22.4h	End Panels 1.5th		L-Panels 6w 0.75th		L-Panels 6w 1.5th		T-Panels 6w 1.5th	
Base Panel 20d 22.4h	DZHA20	692	DZHC20	681	DZHE20	748	DZHG20	806
Base Panel 24d 22.4h	DZHA24	748	DZHC24	711	DZHE24	801	DZHG24	860
• Base Panel 30d 22.4h	DZHA30	801	DZHC30	761	DZHE30	856	DZHG30	916
Base Panel 36d 22.4h	DZHA36	856	DZHC36	807	DZHE36	910	DZHG36	970
28.4h	End Panels 1.5th		L-Panels 6w 0.75th		L-Panels 6w 1.5th		T-Panels 6w 1.5th	
Base Panel 20d 28.4h	DZHB20	748	DZHD20	732	DZHF20	815	DZHH20	875
Base Panel 24d 28.4h	DZHB24	815	DZHD24	771	DZHF24	884	DZHH24	944
• Base Panel 30d 28.4h	DZHB30	884	DZHD30	831	DZHF30	951	DZHH30	1011
Base Panel 36d 28.4h	DZHB36	951	DZHD36	891	DZHF36	1017	DZHH36	1077

! Notes:

End Panels to be used only next to pedestals.
 L-Panels to be used when not next to a pedestal.
 Specify L for left, or R for right hand End or L-panel. Place at the end of the Product number.
 T-Panels must be used on open spans larger than 54w.

Top Supports



1.5th			
Top Supports 12w 4.5h	DZHJ12	592	
• Top Supports 15w 4.5h	DZHJ15	604	
Top Supports 18w 4.5h	DZHJ18	618	

! Notes:

Top supports assist in the transition of tops from standard height to low credenza height.

Tops, High Pressure Laminate



Description	Product No.	List \$	Product No.	List \$	Product No.	List \$	Product No.	List \$	Product No.	List \$	Product No.	List \$		
PVC Edge 1.5th	20d		24d		30d		36d		42d		48d		60d	
Top/Flat HPL:Self 16w	DZJA2016	819	DZJA2416	839	DZJA3016	866	DZJA3616	898	DZJA4216	927	DZJA4816	956	DZJA6016	1016
Top/Flat HPL:Self 18w	DZJA2018	831	DZJA2418	854	DZJA3018	886	DZJA3618	921	DZJA4218	952	DZJA4818	987	DZJA6018	1054
Top/Flat HPL:Self 20w	DZJA2020	845	DZJA2420	866	DZJA3020	906	DZJA3620	944	DZJA4220	979	DZJA4820	1016	DZJA6020	1090
Top/Flat HPL:Self 24w	DZJA2024	866	DZJA2424	898	DZJA3024	944	DZJA3624	987	DZJA4224	1031	DZJA4824	1075	DZJA6024	1166
Top/Flat HPL:Self 30w	DZJA2030	906	DZJA2430	944	DZJA3030	996	DZJA3630	1054	DZJA4230	1109	DZJA4830	1166	DZJA6030	1277
Top/Flat HPL:Self 36w	DZJA2036	944	DZJA2436	987	DZJA3036	1054	DZJA3636	1120	DZJA4236	1187	DZJA4836	1256	DZJA6036	1389
Top/Flat HPL:Self 42w	DZJA2042	979	DZJA2442	1031	DZJA3042	1109	DZJA3642	1187	DZJA4242	1266	DZJA4842	1344	DZJA6042	1499
Top/Flat HPL:Self 48w	DZJA2048	1016	DZJA2448	1075	DZJA3048	1166	DZJA3648	1256	DZJA4248	1344	DZJA4848	1433	DZJA6048	1612
Top/Flat HPL:Self 54w	DZJA2054	1054	DZJA2454	1120	DZJA3054	1219	DZJA3654	1323	DZJA4254	1423	DZJA4854	1521	DZJA6054	1721
• Top/Flat HPL:Self 60w	DZJA2060	1090	DZJA2460	1166	DZJA3060	1277	DZJA3660	1389	DZJA4260	1499	DZJA4860	1612	DZJA6060	1833
Top/Flat HPL:Self 66w	DZJA2066	1129	DZJA2466	1210	DZJA3066	1335	DZJA3666	1455	DZJA4266	1578	DZJA4866	1700	DZJA6066	1946
Top/Flat HPL:Self 72w	DZJA2072	1166	DZJA2472	1256	DZJA3072	1389	DZJA3672	1521	DZJA4272	1656	DZJA4872	1789	DZJA6072	2058
Top/Flat HPL:Self 78w	DZJA2078	1204	DZJA2478	1299	DZJA3078	1445	DZJA3678	1590	DZJA4278	1735	DZJA4878	1878	DZJA6078	2168
Top/Flat HPL:Self 84w	DZJA2084	1239	DZJA2484	1344	DZJA3084	1499	DZJA3684	1656	DZJA4284	1811	DZJA4884	1969	DZJA6084	2281
Top/Flat HPL:Self 90w	DZJA2090	1277	DZJA2490	1389	DZJA3090	1556	DZJA3690	1721	DZJA4290	1892	DZJA4890	2058	DZJA6090	2391
Top/Flat HPL:Self 96w	DZJA2096	1315	DZJA2496	1433	DZJA3096	1612	DZJA3696	1789	DZJA4296	1969	DZJA4896	2146	DZJA6096	2504
Top/Flat HPL:Self 102w	DZJA2102	1350	DZJA24102	1478	DZJA30102	1667	DZJA36102	1856	DZJA42102	2045	DZJA48102	2235	DZJA60102	2616
Top/Flat HPL:Self 108w	DZJA2108	1389	DZJA24108	1521	DZJA30108	1721	DZJA36108	1924	DZJA42108	2124	DZJA48108	2324	DZJA60108	2727
Top/Flat HPL:Self 114w	DZJA2114	1427	DZJA24114	1567	DZJA30114	1779	DZJA36114	1992	DZJA42114	2202	DZJA48114	2413	DZJA60114	2838
Top/Flat HPL:Self 120w	DZJA2120	1464	DZJA24120	1612	DZJA30120	1833	DZJA36120	2058	DZJA42120	2281	DZJA48120	2504	DZJA60120	2949



Description	Suffix Code.	Add \$	Suffix Code	Add \$	Suffix Code	Add \$	Suffix Code.	Add \$	Suffix Code	Add \$	Suffix Code	Add \$	Suffix Code	Add \$
Metal Edge 1.5th	20d		24d		30d		36d		42d		48d		60d	
Top/Flat HPL:Metal 16w	...ME	1184	...ME	1242	...ME	1327	...ME	1412	...ME	1497	...ME	1582	...ME	1754
Top/Flat HPL:Metal 18w	...ME	1212	...ME	1271	...ME	1357	...ME	1439	...ME	1526	...ME	1612	...ME	1781
Top/Flat HPL:Metal 20w	...ME	1242	...ME	1298	...ME	1386	...ME	1468	...ME	1553	...ME	1640	...ME	1810
Top/Flat HPL:Metal 24w	...ME	1298	...ME	1357	...ME	1439	...ME	1526	...ME	1612	...ME	1696	...ME	1869
Top/Flat HPL:Metal 30w	...ME	1386	...ME	1439	...ME	1526	...ME	1612	...ME	1696	...ME	1781	...ME	1953
Top/Flat HPL:Metal 36w	...ME	1468	...ME	1526	...ME	1612	...ME	1696	...ME	1781	...ME	1869	...ME	2037
Top/Flat HPL:Metal 42w	...ME	1553	...ME	1612	...ME	1696	...ME	1781	...ME	1869	...ME	1953	...ME	2123
Top/Flat HPL:Metal 48w	...ME	1640	...ME	1696	...ME	1781	...ME	1869	...ME	1953	...ME	2037	...ME	2209
Top/Flat HPL:Metal 54w	...ME	1722	...ME	1781	...ME	1869	...ME	1953	...ME	2037	...ME	2123	...ME	2293
Top/Flat HPL:Metal 60w	...ME	1810	...ME	1869	...ME	1953	...ME	2037	...ME	2123	...ME	2209	...ME	2379
Top/Flat HPL:Metal 66w	...ME	1896	...ME	1953	...ME	2037	...ME	2123	...ME	2209	...ME	2293	...ME	2464
Top/Flat HPL:Metal 72w	...ME	1981	...ME	2037	...ME	2123	...ME	2209	...ME	2293	...ME	2379	...ME	2549
Top/Flat HPL:Metal 78w	...ME	2065	...ME	2123	...ME	2209	...ME	2293	...ME	2379	...ME	2464	...ME	2636
Top/Flat HPL:Metal 84w	...ME	2153	...ME	2209	...ME	2293	...ME	2379	...ME	2464	...ME	2549	...ME	2722
Top/Flat HPL:Metal 90w	...ME	2237	...ME	2293	...ME	2379	...ME	2464	...ME	2549	...ME	2636	...ME	2805
Top/Flat HPL:Metal 96w	...ME	2321	...ME	2379	...ME	2464	...ME	2549	...ME	2636	...ME	2722	...ME	2890
Top/Flat HPL:Metal 102w	...ME	2407	...ME	2464	...ME	2549	...ME	2636	...ME	2722	...ME	2805	...ME	2978
Top/Flat HPL:Metal 108w	...ME	2494	...ME	2549	...ME	2636	...ME	2722	...ME	2805	...ME	2890	...ME	3062
Top/Flat HPL:Metal 114w	...ME	2577	...ME	2636	...ME	2722	...ME	2805	...ME	2890	...ME	2978	...ME	3147
Top/Flat HPL:Metal 120w	...ME	2664	...ME	2722	...ME	2805	...ME	2890	...ME	2978	...ME	3062	...ME	3233

! Notes:
 HPL is Formica 949 White, Matte.
 For metal edges, append ME to the Product No. and add the price shown above.
 > See page AD27 for additional Notes and Options.

Tops, Wood 1

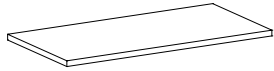

Description	Product No.	List \$	Product No.	List \$	Product No.	List \$	Product No.	List \$	Product No.	List \$	Product No.	List \$	Product No.	List \$
Self Edge, 1.5th	20d		24d		30d		36d		42d		48d		60d	
Top/Flat Wood1:Self 16w	DZJB2016	1273	DZJB2416	1293	DZJB3016	1319	DZJB3616	1347	DZJB4216	1374	DZJB4816	1406	DZJB6016	1460
Top/Flat Wood1:Self 18w	DZJB2018	1283	DZJB2418	1305	DZJB3018	1338	DZJB3618	1369	DZJB4218	1402	DZJB4818	1433	DZJB6018	1497
Top/Flat Wood1:Self 20w	DZJB2020	1297	DZJB2420	1319	DZJB3020	1357	DZJB3620	1390	DZJB4220	1427	DZJB4820	1460	DZJB6020	1531
Top/Flat Wood1:Self 24w	DZJB2024	1319	DZJB2424	1347	DZJB3024	1390	DZJB3624	1433	DZJB4224	1474	DZJB4824	1518	DZJB6024	1601
Top/Flat Wood1:Self 30w	DZJB2030	1357	DZJB2430	1390	DZJB3030	1441	DZJB3630	1497	DZJB4230	1550	DZJB4830	1601	DZJB6030	1709
Top/Flat Wood1:Self 36w	DZJB2036	1390	DZJB2436	1433	DZJB3036	1497	DZJB3636	1559	DZJB4236	1623	DZJB4836	1688	DZJB6036	1813
Top/Flat Wood1:Self 42w	DZJB2042	1427	DZJB2442	1474	DZJB3042	1550	DZJB3642	1623	DZJB4242	1697	DZJB4842	1772	DZJB6042	1920
Top/Flat Wood1:Self 48w	DZJB2048	1460	DZJB2448	1518	DZJB3048	1601	DZJB3648	1688	DZJB4248	1772	DZJB4848	1856	DZJB6048	2027
Top/Flat Wood1:Self 54w	DZJB2054	1497	DZJB2454	1559	DZJB3054	1656	DZJB3654	1751	DZJB4254	1847	DZJB4854	1941	DZJB6054	2133
• Top/Flat Wood1:Self 60w	DZJB2060	1531	DZJB2460	1601	DZJB3060	1709	DZJB3660	1813	DZJB4260	1920	DZJB4860	2027	DZJB6060	2239
Top/Flat Wood1:Self 66w	DZJB2066	1567	DZJB2466	1646	DZJB3066	1761	DZJB3666	1877	DZJB4266	1994	DZJB4866	2112	DZJB6066	2345
Top/Flat Wood1:Self 72w	DZJB2072	1601	DZJB2472	1688	DZJB3072	1813	DZJB3672	1941	DZJB4272	2070	DZJB4872	2197	DZJB6072	2452
Top/Flat Wood1:Self 78w	DZJB2078	1638	DZJB2478	1729	DZJB3078	1869	DZJB3678	2006	DZJB4278	2143	DZJB4878	2283	DZJB6078	2556
Top/Flat Wood1:Self 84w	DZJB2084	1674	DZJB2484	1772	DZJB3084	1920	DZJB3684	2070	DZJB4284	2219	DZJB4884	2365	DZJB6084	2664
Top/Flat Wood1:Self 90w	DZJB2090	1709	DZJB2490	1813	DZJB3090	1974	DZJB3690	2133	DZJB4290	2292	DZJB4890	2452	DZJB6090	2770
Top/Flat Wood1:Self 96w	DZJB2096	1742	DZJB2496	1856	DZJB3096	2027	DZJB3696	2197	DZJB4296	2365	DZJB4896	2537	DZJB6096	2878
Top/Flat Wood1:Self 102w	DZJB2102	1780	DZJB24102	1898	DZJB30102	2079	DZJB36102	2261	DZJB42102	2441	DZJB48102	2620	DZJB60102	2981
Top/Flat Wood1:Self 108w	DZJB2108	1813	DZJB24108	1941	DZJB30108	2133	DZJB36108	2322	DZJB42108	2516	DZJB48108	2706	DZJB60108	3087
Top/Flat Wood1:Self 114w	DZJB2114	1850	DZJB24114	1983	DZJB30114	2185	DZJB36114	2386	DZJB42114	2587	DZJB48114	2791	DZJB60114	3194
Top/Flat Wood1:Self 120w	DZJB2120	1883	DZJB24120	2027	DZJB30120	2239	DZJB36120	2452	DZJB42120	2664	DZJB48120	2878	DZJB60120	3302

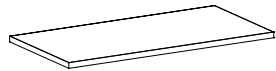

Description	Suffix Code.	Add \$	Suffix Code	Add \$	Suffix Code	Add \$	Suffix Code.	Add \$	Suffix Code	Add \$	Suffix Code	Add \$	Suffix Code	Add \$
Metal Edge 1.5th	20d		24d		30d		36d		42d		48d		60d	
Top/Flat Wood1:Metal 16w	...ME	1184	...ME	1242	...ME	1327	...ME	1412	...ME	1497	...ME	1582	...ME	1754
Top/Flat Wood1:Metal 18w	...ME	1212	...ME	1271	...ME	1357	...ME	1439	...ME	1526	...ME	1612	...ME	1781
Top/Flat Wood1:Metal 20w	...ME	1242	...ME	1298	...ME	1386	...ME	1468	...ME	1553	...ME	1640	...ME	1810
Top/Flat Wood1:Metal 24w	...ME	1298	...ME	1357	...ME	1439	...ME	1526	...ME	1612	...ME	1696	...ME	1869
Top/Flat Wood1:Metal 30w	...ME	1386	...ME	1439	...ME	1526	...ME	1612	...ME	1696	...ME	1781	...ME	1953
Top/Flat Wood1:Metal 36w	...ME	1468	...ME	1526	...ME	1612	...ME	1696	...ME	1781	...ME	1869	...ME	2037
Top/Flat Wood1:Metal 42w	...ME	1553	...ME	1612	...ME	1696	...ME	1781	...ME	1869	...ME	1953	...ME	2123
Top/Flat Wood1:Metal 48w	...ME	1640	...ME	1696	...ME	1781	...ME	1869	...ME	1953	...ME	2037	...ME	2209
Top/Flat Wood1:Metal 54w	...ME	1722	...ME	1781	...ME	1869	...ME	1953	...ME	2037	...ME	2123	...ME	2293
Top/Flat Wood1:Metal 60w	...ME	1810	...ME	1869	...ME	1953	...ME	2037	...ME	2123	...ME	2209	...ME	2379
Top/Flat Wood1:Metal 66w	...ME	1896	...ME	1953	...ME	2037	...ME	2123	...ME	2209	...ME	2293	...ME	2464
Top/Flat Wood1:Metal 72w	...ME	1981	...ME	2037	...ME	2123	...ME	2209	...ME	2293	...ME	2379	...ME	2549
Top/Flat Wood1:Metal 78w	...ME	2065	...ME	2123	...ME	2209	...ME	2293	...ME	2379	...ME	2464	...ME	2636
Top/Flat Wood1:Metal 84w	...ME	2153	...ME	2209	...ME	2293	...ME	2379	...ME	2464	...ME	2549	...ME	2722
Top/Flat Wood1:Metal 90w	...ME	2237	...ME	2293	...ME	2379	...ME	2464	...ME	2549	...ME	2636	...ME	2805
Top/Flat Wood1:Metal 96w	...ME	2321	...ME	2379	...ME	2464	...ME	2549	...ME	2636	...ME	2722	...ME	2890
Top/Flat Wood1:Metal 102w	...ME	2407	...ME	2464	...ME	2549	...ME	2636	...ME	2722	...ME	2805	...ME	2978
Top/Flat Wood1:Metal 108w	...ME	2494	...ME	2549	...ME	2636	...ME	2722	...ME	2805	...ME	2890	...ME	3062
Top/Flat Wood1:Metal 114w	...ME	2577	...ME	2636	...ME	2722	...ME	2805	...ME	2890	...ME	2978	...ME	3147
Top/Flat Wood1:Metal 120w	...ME	2664	...ME	2722	...ME	2805	...ME	2890	...ME	2978	...ME	3062	...ME	3233

! Notes:
 HPL is Formica 949 White, Matte.
 For metal edges, append ME to the Product No. and add the price shown above.
 > See page AD27 for additional Notes and Options.

Tops, Solid Surface

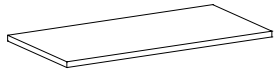

Description	Product No.	List \$	Product No.	List \$	Product No.	List \$	Product No.	List \$	Product No.	List \$	Product No.	List \$	Product No.	List \$
Self Edge, 1.5th	20d		24d		30d		36d		42d		48d		60d	
Top/Flat SolidS:Self 16w	DZJC2016	1845	DZJC2416	1910	DZJC3016	1920	DZJC3616	2001	DZJC4216	2084	DZJC4816	2162	DZJC6016	2322
Top/Flat SolidS:Self 18w	DZJC2018	1876	DZJC2418	1952	DZJC3018	1972	DZJC3618	2062	DZJC4218	2154	DZJC4818	2244	DZJC6018	2424
Top/Flat SolidS:Self 20w	DZJC2020	1908	DZJC2420	1994	DZJC3020	2022	DZJC3620	2123	DZJC4220	2223	DZJC4820	2322	DZJC6020	2523
Top/Flat SolidS:Self 24w	DZJC2024	1938	DZJC2424	2036	DZJC3024	2123	DZJC3624	2244	DZJC4224	2364	DZJC4824	2484	DZJC6024	2727
Top/Flat SolidS:Self 30w	DZJC2030	2112	DZJC2430	2233	DZJC3030	2274	DZJC3630	2424	DZJC4230	2576	DZJC4830	2727	DZJC6030	3026
Top/Flat SolidS:Self 36w	DZJC2036	2172	DZJC2436	2318	DZJC3036	2424	DZJC3636	2606	DZJC4236	2787	DZJC4836	2966	DZJC6036	3330
Top/Flat SolidS:Self 42w	DZJC2042	2233	DZJC2442	2403	DZJC3042	2576	DZJC3642	2787	DZJC4242	2997	DZJC4842	3209	DZJC6042	3631
Top/Flat SolidS:Self 48w	DZJC2048	2407	DZJC2448	2602	DZJC3048	2727	DZJC3648	2966	DZJC4248	3209	DZJC4848	3449	DZJC6048	3933
Top/Flat SolidS:Self 54w	DZJC2054	2469	DZJC2454	2687	DZJC3054	2878	DZJC3654	3148	DZJC4254	3421	DZJC4854	3690	DZJC6054	4235
Top/Flat SolidS:Self 60w	DZJC2060	2529	DZJC2460	2772	DZJC3060	3026	DZJC3660	3330	DZJC4260	3631	DZJC4860	3933	DZJC6060	4536
Top/Flat SolidS:Self 66w	DZJC2066	2589	DZJC2466	2857	DZJC3066	3178	DZJC3666	3509	DZJC4266	3841	DZJC4866	4173	DZJC6066	4836
Top/Flat SolidS:Self 72w	DZJC2072	2764	DZJC2472	3054	DZJC3072	3330	DZJC3672	3690	DZJC4272	4054	DZJC4872	4416	DZJC6072	5140
Top/Flat SolidS:Self 78w	DZJC2078	2825	DZJC2478	3138	DZJC3078	3481	DZJC3678	3872	DZJC4278	4263	DZJC4878	4657	DZJC6078	5441
Top/Flat SolidS:Self 84w	DZJC2084	2885	DZJC2484	3225	DZJC3084	3631	DZJC3684	4054	DZJC4284	4476	DZJC4884	4897	DZJC6084	5742
Top/Flat SolidS:Self 90w	DZJC2090	3060	DZJC2490	3422	DZJC3090	3780	DZJC3690	4235	DZJC4290	4684	DZJC4890	5140	DZJC6090	6045
Top/Flat SolidS:Self 96w	DZJC2096	3121	DZJC2496	3507	DZJC3096	3933	DZJC3696	4416	DZJC4296	4897	DZJC4896	5380	DZJC6096	6345
Top/Flat SolidS:Self 102w	DZJC2102	3294	DZJC24102	3704	DZJC30102	4083	DZJC36102	4596	DZJC42102	5109	DZJC48102	5623	DZJC60102	6645
Top/Flat SolidS:Self 108w	DZJC2108	3355	DZJC24108	3789	DZJC30108	4235	DZJC36108	4776	DZJC42108	5319	DZJC48108	5864	DZJC60108	6948
Top/Flat SolidS:Self 114w	DZJC2114	3416	DZJC24114	3875	DZJC30114	4385	DZJC36114	4958	DZJC42114	5531	DZJC48114	6106	DZJC60114	7249
Top/Flat SolidS:Self 120w	DZJC20120	3477	DZJC24120	3961	DZJC30120	4536	DZJC36120	5140	DZJC42120	5742	DZJC48120	6345	DZJC60120	7553

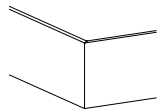

Description	Suffix Code.	Add \$	Suffix Code	Add \$	Suffix Code	Add \$	Suffix Code.	Add \$	Suffix Code	Add \$	Suffix Code	Add \$	Suffix Code	Add \$
Metal Edge 1.5th	20d		24d		30d		36d		42d		48d		60d	
Top/Flat SolidS:Metal 16w	...ME	1184	...ME	1242	...ME	1327	...ME	1412	...ME	1497	...ME	1582	...ME	1754
Top/Flat SolidS:Metal 18w	...ME	1212	...ME	1271	...ME	1357	...ME	1439	...ME	1526	...ME	1612	...ME	1781
Top/Flat SolidS:Metal 20w	...ME	1242	...ME	1298	...ME	1386	...ME	1468	...ME	1553	...ME	1640	...ME	1810
Top/Flat SolidS:Metal 24w	...ME	1298	...ME	1357	...ME	1439	...ME	1526	...ME	1612	...ME	1696	...ME	1869
Top/Flat SolidS:Metal 30w	...ME	1386	...ME	1439	...ME	1526	...ME	1612	...ME	1696	...ME	1781	...ME	1953
Top/Flat SolidS:Metal 36w	...ME	1468	...ME	1526	...ME	1612	...ME	1696	...ME	1781	...ME	1869	...ME	2037
Top/Flat SolidS:Metal 42w	...ME	1553	...ME	1612	...ME	1696	...ME	1781	...ME	1869	...ME	1953	...ME	2123
Top/Flat SolidS:Metal 48w	...ME	1640	...ME	1696	...ME	1781	...ME	1869	...ME	1953	...ME	2037	...ME	2209
Top/Flat SolidS:Metal 54w	...ME	1722	...ME	1781	...ME	1869	...ME	1953	...ME	2037	...ME	2123	...ME	2293
Top/Flat SolidS:Metal 60w	...ME	1810	...ME	1869	...ME	1953	...ME	2037	...ME	2123	...ME	2209	...ME	2379
Top/Flat SolidS:Metal 66w	...ME	1896	...ME	1953	...ME	2037	...ME	2123	...ME	2209	...ME	2293	...ME	2464
Top/Flat SolidS:Metal 72w	...ME	1981	...ME	2037	...ME	2123	...ME	2209	...ME	2293	...ME	2379	...ME	2549
Top/Flat SolidS:Metal 78w	...ME	2065	...ME	2123	...ME	2209	...ME	2293	...ME	2379	...ME	2464	...ME	2636
Top/Flat SolidS:Metal 84w	...ME	2153	...ME	2209	...ME	2293	...ME	2379	...ME	2464	...ME	2549	...ME	2722
Top/Flat SolidS:Metal 90w	...ME	2237	...ME	2293	...ME	2379	...ME	2464	...ME	2549	...ME	2636	...ME	2805
Top/Flat SolidS:Metal 96w	...ME	2321	...ME	2379	...ME	2464	...ME	2549	...ME	2636	...ME	2722	...ME	2890
Top/Flat SolidS:Metal 102w	...ME	2407	...ME	2464	...ME	2549	...ME	2636	...ME	2722	...ME	2805	...ME	2978
Top/Flat SolidS:Metal 108w	...ME	2494	...ME	2549	...ME	2636	...ME	2722	...ME	2805	...ME	2890	...ME	3062
Top/Flat SolidS:Metal 114w	...ME	2577	...ME	2636	...ME	2722	...ME	2805	...ME	2890	...ME	2978	...ME	3147
Top/Flat SolidS:Metal 120w	...ME	2664	...ME	2722	...ME	2805	...ME	2890	...ME	2978	...ME	3062	...ME	3233

! Notes:

- Solid Surface is Avonite® 8016 White, Matte.
- For metal edges, append ME to the Product No. and add the price shown above.
- > See page AD27 for additional Notes and Options.

Tops, Matte BPGlass



Description	Product No.	List \$	Product No.	List \$	Product No.	List \$	Product No.	List \$	Product No.	List \$	Product No.	List \$	Product No.	List \$
Metal Edge, 1.5th	20d		24d		30d		36d		42d		48d		60d	
Top/Flat OBPG: Metal 16w	DZJD2016	2306	DZJD2416	2441	DZJD3016	2645	DZJD3616	2852	DZJD4216	3058	DZJD4816	3263	DZJD6016	3675
Top/Flat OBPG: Metal 18w	DZJD2018	2381	DZJD2418	2529	DZJD3018	2751	DZJD3618	2969	DZJD4218	3190	DZJD4818	3410	DZJD6018	3851
Top/Flat OBPG: Metal 20w	DZJD2020	2461	DZJD2420	2619	DZJD3020	2853	DZJD3620	3088	DZJD4220	3325	DZJD4820	3558	DZJD6020	4032
Top/Flat OBPG: Metal 24w	DZJD2024	2619	DZJD2424	2796	DZJD3024	3061	DZJD3624	3326	DZJD4224	3591	DZJD4824	3857	DZJD6024	4389
Top/Flat OBPG: Metal 30w	DZJD2030	2853	DZJD2430	3061	DZJD3030	3372	DZJD3630	3681	DZJD4230	3992	DZJD4830	4302	DZJD6030	4925
Top/Flat OBPG: Metal 36w	DZJD2036	3088	DZJD2436	3326	DZJD3036	3681	DZJD3636	4036	DZJD4236	4393	DZJD4836	4746	DZJD6036	5461
Top/Flat OBPG: Metal 42w	DZJD2042	3325	DZJD2442	3591	DZJD3042	3992	DZJD3642	4393	DZJD4242	4794	DZJD4842	5193	DZJD6042	5996
Top/Flat OBPG: Metal 48w	DZJD2048	3558	DZJD2448	3857	DZJD3048	4302	DZJD3648	4746	DZJD4248	5193	DZJD4848	5643	DZJD6048	6532
Top/Flat OBPG: Metal 54w	DZJD2054	3795	DZJD2454	4123	DZJD3054	4613	DZJD3654	5103	DZJD4254	5594	DZJD4854	6087	DZJD6054	7065
Top/Flat OBPG: Metal 60w	DZJD2060	4032	DZJD2460	4389	DZJD3060	4925	DZJD3660	5461	DZJD4260	5996	DZJD4860	6532	DZJD6060	7603
Top/Flat OBPG: Metal 66w	DZJD2066	4264	DZJD2466	4654	DZJD3066	5233	DZJD3666	5815	DZJD4266	6395	DZJD4866	6977	DZJD6066	8139
Top/Flat OBPG: Metal 72w	DZJD2072	4501	DZJD2472	4920	DZJD3072	5547	DZJD3672	6172	DZJD4272	6798	DZJD4872	7425	DZJD6072	8674
Top/Flat OBPG: Metal 78w	DZJD2078	4738	DZJD2478	5185	DZJD3078	5855	DZJD3678	6526	DZJD4278	7200	DZJD4878	7869	DZJD6078	9213
Top/Flat OBPG: Metal 84w	DZJD2084	4975	DZJD2484	5450	DZJD3084	6167	DZJD3684	6882	DZJD4284	7599	DZJD4884	8315	DZJD6084	9747
Top/Flat OBPG: Metal 90w	DZJD2090	5208	DZJD2490	5715	DZJD3090	6477	DZJD3690	7239	DZJD4290	7998	DZJD4890	8759	DZJD6090	10283
Top/Flat OBPG: Metal 96w	DZJD2096	5443	DZJD2496	5980	DZJD3096	6788	DZJD3696	7593	DZJD4296	8399	DZJD4896	9207	DZJD6096	10817
Top/Flat OBPG: Metal 102w	DZJD2102	5678	DZJD24102	6248	DZJD3102	7098	DZJD36102	7950	DZJD42102	8799	DZJD48102	9652	DZJD60102	11354
Top/Flat OBPG: Metal 108w	DZJD2108	5916	DZJD24108	6512	DZJD3108	7409	DZJD36108	8306	DZJD42108	9201	DZJD48108	10097	DZJD60108	11889
Top/Flat OBPG: Metal 114w	DZJD2114	6152	DZJD24114	6778	DZJD3114	7720	DZJD36114	8660	DZJD42114	9601	DZJD48114	10543	DZJD60114	12427
Top/Flat OBPG: Metal 120w	DZJD2120	6387	DZJD24120	7043	DZJD3120	8030	DZJD36120	9015	DZJD42120	10003	DZJD48120	10989	DZJD60120	12961

! Notes—Tops this page only:
 Matte BPGlass (Back-Painted) is Writable; specify (GMB) Black or (GMW) White.
 Matte BPGlass tops have a metal edge.

! Notes—All Tops:
 Metal edge finish is (MRBAS) Metal Resin Brushed Aluminum w/ Steel Tint.
 Metal edge will be on all edges of tops where applicable.
 Tops are 1 piece construction, so verify on larger tops that they will fit into space.

+ Options—All Tops:
 For Brush grommet/ Pencil Catch add BG to spec code and add \$7 per inch.
 Brush grommets/Pencil Catches, must be 12 inches smaller than full width of top, 6in from each end of top minimum.
 Ex. 72 inch top would get a max size brush grommet of 60 inch and the cost would be \$420.

Top Dividers

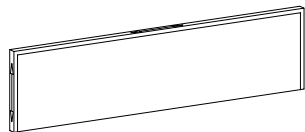
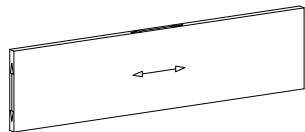
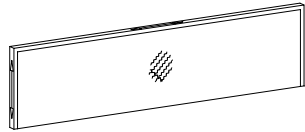

Description	COM yds	Product No.	List \$	Product No.	List \$	Product No.	List \$	Product No.	List \$
		12h		15h		20h		24h	
Fabric									
Fabric: Magnetic 20w	1	DZKA2012	1611	DZKA2015	1676	DZKA2020	1749	DZKA2024	1792
Fabric: Magnetic 24w	1	DZKA2412	1657	DZKA2415	1742	DZKA2420	1824	DZKA2424	1892
Fabric: Magnetic 30w	1	DZKA3012	1716	DZKA3015	1823	DZKA3020	1916	DZKA3024	2007
Fabric: Magnetic 36w	1.2	DZKA3612	1773	DZKA3615	1902	DZKA3620	2009	DZKA3624	2123
Fabric: Magnetic 42w	1.4	DZKA4212	1832	DZKA4215	1981	DZKA4220	2100	DZKA4224	2239
Fabric: Magnetic 48w	1.5	DZKA4812	1892	DZKA4815	2060	DZKA4820	2195	DZKA4824	2355
• Fabric: Magnetic 54w	1.7	DZKA5412	1948	DZKA5415	2139	DZKA5420	2286	DZKA5424	2471
Fabric: Magnetic 60w	1.9	DZKA6012	2007	DZKA6015	2221	DZKA6020	2379	DZKA6024	2586
Fabric: Magnetic 66w	2	DZKA6612	2064	DZKA6615	2298	DZKA6620	1903	DZKA6624	2705
Fabric: Magnetic 72w	2.2	DZKA7212	2123	DZKA7215	2379	DZKA7220	2563	DZKA7224	2821
Fabric: Magnetic 78w	2.4	DZKA7812	2181	DZKA7815	2457	DZKA7820	2658	DZKA7824	2937
		12h		15h		20h		24h	
Wood									
Wood: 20w		DZKB2012	1259	DZKB2015	1302	DZKB2020	1329	DZKB2024	1341
Wood: 24w		DZKB2412	1288	DZKB2415	1341	DZKB2420	1370	DZKB2424	1394
Wood: 30w		DZKB3012	1315	DZKB3015	1384	DZKB3020	1410	DZKB3024	1452
Wood: 36w		DZKB3612	1341	DZKB3615	1426	DZKB3620	1453	DZKB3624	1505
Wood: 42w		DZKB4212	1368	DZKB4215	1464	DZKB4220	1494	DZKB4224	1558
Wood: 48w		DZKB4812	1394	DZKB4815	1505	DZKB4820	1533	DZKB4824	1614
• Wood: 54w		DZKB5412	1426	DZKB5415	1547	DZKB5420	1575	DZKB5424	1670
Wood: 60w		DZKB6012	1452	DZKB6015	1587	DZKB6020	1616	DZKB6024	1721
Wood: 66w		DZKB6612	1478	DZKB6615	1628	DZKB6620	1657	DZKB6624	1778
Wood: 72w		DZKB7212	1505	DZKB7215	1670	DZKB7220	1696	DZKB7224	1832
Wood: 78w		DZKB7812	1531	DZKB7815	1709	DZKB7820	1739	DZKB7824	1884
		12h		15h		20h		24h	
Matte BPGlass									
Matte BPGlass: Magnetic 20w		DZKC2012	2217	DZKC2015	2433	DZKC2020	2757	DZKC2024	3004
Matte BPGlass: Magnetic 24w		DZKC2412	2384	DZKC2415	2649	DZKC2420	3032	DZKC2424	3342
Matte BPGlass: Magnetic 30w		DZKC3012	2624	DZKC3015	2955	DZKC3020	3427	DZKC3024	3819
Matte BPGlass: Magnetic 36w		DZKC3612	2862	DZKC3615	3263	DZKC3620	3821	DZKC3624	4300
Matte BPGlass: Magnetic 42w		DZKC4212	3103	DZKC4215	3569	DZKC4220	4217	DZKC4224	4778
Matte BPGlass: Magnetic 48w		DZKC4812	3342	DZKC4815	3873	DZKC4820	4612	DZKC4824	5257
• Matte BPGlass: Magnetic 54w		DZKC5412	3579	DZKC5415	4182	DZKC5420	5006	DZKC5424	5736
Matte BPGlass: Magnetic 60w		DZKC6012	3819	DZKC6015	4486	DZKC6020	5401	DZKC6024	6215
Matte BPGlass: Magnetic 66w		DZKC6612	4059	DZKC6615	4794	DZKC6620	1903	DZKC6624	6695
Matte BPGlass: Magnetic 72w		DZKC7212	4300	DZKC7215	5098	DZKC7220	6191	DZKC7224	7174
Matte BPGlass: Magnetic 78w		DZKC7812	4538	DZKC7815	5404	DZKC7820	6584	DZKC7824	7652

! Notes:
 All Dividers are two sided.
 All Dividers have a 0.75 Wood1 edge.
 Matte BPGlass (Back-Painted) is Writable; specify (GMB) Black or (GMW) White.
 Fabric panels are COM.
 Glass panels and Fabric panels are magnetic.
 Dividers are 1.5 inches thick.

Hutches, Open Shelving

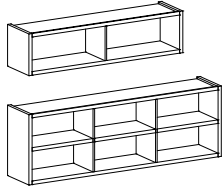

Description	Product No.	List \$	Product No.	List \$	Product No.	List \$	Product No.	List \$
18d	17.5h		29.5h					
Open Shelving 36w	DZLAA36	3260		DZLAB36	4232			
Open Shelving 48w	DZLAA48	3402		DZLAB48	4374			
Open Shelving 54w	DZLAA54	3473		DZLAB54	4446			
Open Shelving 60w	DZLAA60	3546		DZLAB60	4517			
Open Shelving 66w	DZLAA66	3616		DZLAB66	4628			
• Open Shelving 72w	DZLAA72	3687		DZLAB72	4741			
Open Shelving 78w	DZLAA78	3757		DZLAB78	4854			
Open Shelving 84w	DZLAA84	3830		DZLAB84	4964			
• Open Shelving 90w	DZLAA90	3902		DZLAB90	5077			
Open Shelving 96w	DZLAA96	3973		DZLAB96	5188			
Open Shelving 102w	DZLAA102	4043		DZLAB102	5304			
Open Shelving 108w	DZLAA108	4117		DZLAB108	5414			
Open Shelving 114w	DZLAA114	4188		DZLAB114	5527			
Open Shelving 120w	DZLAA120	4258		DZLAB120	5636			

Hutches, Cabinet Doors

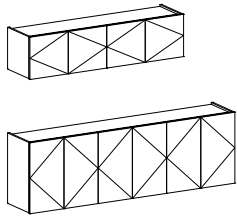

18d	#Doors	17.5h			29.5h				
		Wood1 Doors	Matte BPGlass Doors		Wood1 Doors	Matte BPGlass Doors			
Cabinet Doors 36w	2	DZLBW36	3550	DZLBG36	5278	DZLCW36	4521	DZLCG36	6675
Cabinet Doors 48w	3	DZLBW48	3765	DZLBG48	5539	DZLCW48	4738	DZLCG48	6875
Cabinet Doors 54w	3	DZLBW54	3871	DZLBG54	5668	DZLCW54	4843	DZLCG54	6973
Cabinet Doors 60w	3	DZLBW60	3977	DZLBG60	5800	DZLCW60	4952	DZLCG60	7074
Cabinet Doors 66w	4	DZLBW66	4111	DZLBG66	6112	DZLCW66	5098	DZLCG66	7457
• Cabinet Doors 72w	4	DZLBW72	4218	DZLBG72	6404	DZLCW72	5247	DZLCG72	7842
Cabinet Doors 78w	4	DZLBW78	4325	DZLBG78	6693	DZLCW78	5395	DZLCG78	8226
Cabinet Doors 84w	5	DZLBW84	4458	DZLBG84	7008	DZLCW84	5541	DZLCG84	8611
Cabinet Doors 90w	5	DZLBW90	4564	DZLBG90	7296	DZLCW90	5690	DZLCG90	8995
Cabinet Doors 96w	6	DZLBW96	4698	DZLBG96	7608	DZLCW96	5838	DZLCG96	9379
Cabinet Doors 102w	6	DZLBW102	4805	DZLBG102	7899	DZLCW102	5985	DZLCG102	9764
Cabinet Doors 108w	6	DZLBW108	4912	DZLBG108	8188	DZLCW108	6133	DZLCG108	10147
Cabinet Doors 114w	6	DZLBW114	5019	DZLBG114	8477	DZLCW114	6281	DZLCG114	10533
Cabinet Doors 120w	6	DZLBW120	5124	DZLBG120	8766	DZLCW120	6429	DZLCG120	10917

! Notes:

- Matte BPGlass (Back-Painted) is Writable; specify (GMB) Black or (GMW) White.
- Open End Options allowed on Open Shelving, Sliding Doors, and L Sliding Doors.
- For Open end left add A to the end of Product number.
- For Open end right add B to the end of the Product number.
- For Open end Both ends add C to the end of the Product number. Only allowed on 102w and greater.
- All Shelves are fixed, except for Cabinet door hutches.
- All Hutches come in one piece up to 120-in, please notify CSR if needed in 2 piece construction.

Description	#Doors	17.5h		29.5h		List \$	Product No.	List \$	Product No.
		Wood1 Doors	Matte BPGlass Doors	Wood1 Doors	Matte BPGlass Doors				
Hutches, Sliding Doors									
Sliding Doors 48w	1	DZLDW48	4562	DZLDG48	5509	DZLEW48	5606	DZLEG48	6451
Sliding Doors 54w	1	DZLDW54	4634	DZLDG54	5583	DZLEW54	5717	DZLEG54	6554
Sliding Doors 60w	1	DZLDW60	4740	DZLDG60	5689	DZLEW60	5833	DZLEG60	6659
Sliding Doors 66w	1	DZLDW66	4848	DZLDG66	5985	DZLEW66	6003	DZLEG66	7064
• Sliding Doors 72w	1	DZLDW72	4955	DZLDG72	6297	DZLEW72	6174	DZLEG72	7473
Sliding Doors 78w	2	DZLDW78	5062	DZLDG78	6609	DZLEW78	6347	DZLEG78	7878
Sliding Doors 84w	2	DZLDW84	5168	DZLDG84	6922	DZLEW84	6518	DZLEG84	8285
Sliding Doors 90w	2	DZLDW90	5274	DZLDG90	7278	DZLEW90	6691	DZLEG90	8691
Sliding Doors 96w	2	DZLDW96	5381	DZLDG96	7544	DZLEW96	6861	DZLEG96	9098
Sliding Doors 102w	2	DZLDW102	5913	DZLDG102	8282	DZLEW102	7457	DZLEG102	9899
Sliding Doors 108w	2	DZLDW108	6020	DZLDG108	8548	DZLEW108	7629	DZLEG108	10305
Sliding Doors 114w	2	DZLDW114	6129	DZLDG114	8861	DZLEW114	7800	DZLEG114	10712
Sliding Doors 120w	2	DZLDW120	6235	DZLDG120	9172	DZLEW120	7972	DZLEG120	11117

Description	#Doors	17.5h		29.5h		List \$	Product No.	List \$	Product No.
		Wood1 Doors	Matte BPGlass Doors	Wood1 Doors	Matte BPGlass Doors				
Hutches, L-Sliding Door									
L- Sliding Door 48w	1	DZLFW48	4424	DZLFG48	5372	—	—	—	—
L- Sliding Door 54w	1	DZLFW54	4517	DZLFG54	5466	—	—	—	—
L- Sliding Door 60w	1	DZLFW60	4699	DZLFG60	5648	—	—	—	—
L- Sliding Door 66w	1	DZLFW66	4792	DZLFG66	5930	—	—	—	—
L- Sliding Door 72w	1	DZLFW72	4887	DZLFG72	6230	—	—	—	—
L- Sliding Door 78w	1	DZLFW78	5066	DZLFG78	6615	—	—	—	—
L- Sliding Door 84w	1	DZLFW84	5222	DZLFG84	6973	—	—	—	—
L- Sliding Door 90w	1	DZLFW90	5314	DZLFG90	7317	—	—	—	—
L- Sliding Door 96w	1	DZLFW96	5793	DZLFG96	7956	—	—	—	—
• L- Sliding Door 102w	2	DZLFW102	5886	DZLFG102	8255	—	—	—	—
L- Sliding Door 108w	2	DZLFW108	5980	DZLFG108	8509	—	—	—	—
L- Sliding Door 114w	2	DZLFW114	6281	DZLFG114	9013	—	—	—	—
L- Sliding Door 120w	2	DZLFW120	6379	DZLFG120	9314	—	—	—	—

! Notes:

- Matte BPGlass (Back-Painted) is Writable; specify (GMB) Black or (GMW) White.
- Open End Options allowed on Open Shelving, Sliding Doors, and L Sliding Doors.
- For Open end left add A to the end of Product number.
- For Open end right add B to the end of the Product number.
- For Open end Both ends add C to the end of the Product number. Only allowed on 102w and greater.
- All Shelves are fixed, except for Cabinet door hutches.
- All Hutches come in one piece up to 120-in, please notify CSR if needed in 2 piece construction.

Description	Product No.	List \$	17.5h		29.5h		List \$	Product No.	List \$	
			Product No.	List \$	Product No.	List \$				
Hutches, BI-Pass Sliding Door 	18d		17.5h		29.5h					
		#Doors	Wood1	Doors	Matte BPGlass	Doors	Wood1	Doors	Matte BPGlass	
	Bi-Pass SlideDr 60w	2	DZLGW60	4981	—	—	DZLHW60	6191	—	—
	Bi-Pass SlideDr 66w	2	DZLGW66	5088	—	—	DZLHW66	6362	—	—
	Bi-Pass SlideDr 72w	2	DZLGW72	5196	—	—	DZLHW72	6534	—	—
	Bi-Pass SlideDr 78w	2	DZLGW78	5304	—	—	DZLHW78	6705	—	—
	Bi-Pass SlideDr 84w	2	DZLGW84	5409	—	—	DZLHW84	6876	—	—
	Bi-Pass SlideDr 90w	2	DZLGW90	5517	—	—	DZLHW90	7049	—	—
	Bi-Pass SlideDr 96w	2	DZLGW96	5624	—	—	DZLHW96	7220	—	—
	Bi-Pass SlideDr 102w	4	DZLGW102	5729	—	—	DZLHW102	7391	—	—
	Bi-Pass SlideDr 108w	4	DZLGW108	5838	—	—	DZLHW108	7564	—	—
	Bi-Pass SlideDr 114w	4	DZLGW114	5945	—	—	DZLHW114	7734	—	—
	Bi-Pass SlideDr 120w	4	DZLGW120	6049	—	—	DZLHW120	7908	—	—

! Notes:

Matte BPGlass (Back-Painted) is Writable; specify (GMB) Black or (GMW) White.
 Bi-Pass Door hutches DO NOT allow for Legal Redweld.
 All Shelves are fixed, except for Cabinet door hutches.
 All Hutches come in one piece up to 120-in, please notify CSR if needed in 2 piece construction.

Task Lights for Hutches



	w	Product No.	List \$
LED Lights 36w	30	DZLED36	677
LED Lights 48w	42	DZLED48	723
LED Lights 54w	48	DZLED54	768
LED Lights 60w	54	DZLED60	814
LED Lights 66w	60	DZLED66	859
LED Lights 72w	60	DZLED72	865
LED Lights 78w	72	DZLED78	930
LED Lights 84w	72	DZLED84	941
LED Lights 90w	84	DZLED90	1005
LED Lights 96w	84	DZLED96	1012
LED Lights 102w	96	DZLED102	1112
LED Lights 108w	96	DZLED108	1120
LED Lights 114w	108	DZLED114	1177
LED Lights 120w	108	DZLED120	1185

! Notes:

Order lights for the size of hutch.
 Switch is a wireless dimmer, located in worksurface unless otherwise specified.
 Lights are 3500k; Inquire with Customer Service for other Kelvin Temperatures.
 5.5 Watt/Ft
 615 Lumens/Ft
 115 Degree Beam Angle
 >90 Color Rendering Index (CRI)

Description	#Shelves	Product No.	List \$	Product No.	List \$	Product No.	List \$	Product No.	List \$	Product No.	List \$	Product No.	List \$	Product No.	List \$
Wall Panels, Wood1															
	h	30w	36w	42w	48w	54w	60w	66w	72w						
Flush: Credenza: Hutch	25.1	1	DZMWA30 2889	DZMWA36 3012	DZMWA42 3135	DZMWA48 3263	DZMWA54 3387	DZMWA60 3512	DZMWA66 3635	DZMWA72 3760					
Flush: Low Credenza: Hutch	31.1	1	DZMWB30 3025	DZMWB36 3169	DZMWB42 3311	DZMWB48 3455	DZMWB54 3596	DZMWB60 3741	DZMWB66 3885	DZMWB72 4029					
Flush: Credenza: 60.5h oa	30.6	2	DZMWC30 2980	DZMWC36 3115	DZMWC42 3254	DZMWC48 3390	DZMWC54 3527	DZMWC60 3663	DZMWC66 3801	DZMWC72 3939					
Flush: Low Credenza: 60.5h oa	36.6	2	DZMWD30 3115	DZMWD36 3271	DZMWD42 3427	DZMWD48 3585	DZMWD54 3740	DZMWD60 3896	DZMWD66 4050	DZMWD72 4205					
Flush: Credenza: 72.5h oa	42.6	2	DZMWE30 3254	DZMWE36 3427	DZMWE42 3603	DZMWE48 3775	DZMWE54 3950	DZMWE60 4124	DZMWE66 4298	DZMWE72 4473					
Flush: Low Credenza: 72.5h oa	48.6	2	DZMWF30 3390	DZMWF36 3585	DZMWF42 3775	DZMWF48 3969	DZMWF54 4161	DZMWF60 4353	DZMWF66 4547	DZMWF72 4740					
Flush: Credenza: 84.5h oa	54.6	3	DZMWG30 3527	DZMWG36 3740	DZMWG42 3950	DZMWG48 4161	DZMWG54 4373	DZMWG60 4583	DZMWG66 4796	DZMWG72 5006					
Flush: Low Credenza: 84.5h oa	60.6	3	DZMWH30 3663	DZMWH36 3896	DZMWH42 4124	DZMWH48 4353	DZMWH54 4583	DZMWH60 4815	DZMWH66 5045	DZMWH72 5273					
Floor: Overhead	54.5	3	DZMWJ30 3527	DZMWJ36 3740	DZMWJ42 3950	DZMWJ48 4161	DZMWJ54 4373	DZMWJ60 4583	DZMWJ66 4796	DZMWJ72 5006					
Floor: 60.5h oa	60	4	DZMWK30 3663	DZMWK36 3896	DZMWK42 4124	DZMWK48 4353	DZMWK54 4583	DZMWK60 4815	DZMWK66 5045	DZMWK72 5273					
Floor: 72.5h oa	72	4	DZMWL30 3939	DZMWL36 4205	DZMWL42 4473	DZMWL48 4740	DZMWL54 5006	DZMWL60 5273							
Floor: 84.5h oa	84	5	DZMWM30 4213	DZMWM36 4517	DZMWM42 4822	DZMWM48 5124	DZMWM54 5430	DZMWM60 5734							
	h	78w	84w	90w	96w	102w	108w	114w	120w						
Flush: Credenza: Hutch	25.1	1	DZMWA78 3885	DZMWA84 4010	DZMWA90 4135	DZMWA96 4258	DZMWA102 4384	DZMWA108 4508	DZMWA114 4634	DZMWA120 4759					
Flush: Low Credenza: Hutch	31.1	1	DZMWB78 4171	DZMWB84 4314	DZMWB90 4457	DZMWB96 4601	DZMWB102 4744	DZMWB108 4888	DZMWB114 5030	DZMWB120 5173					
Flush: Credenza: 60.5h oa	30.6	2	DZMWC78 4075	DZMWC84 4213	DZMWC90 4351	DZMWC96 4486	DZMWC102 4625	DZMWC108 4762	DZMWC114 4899	DZMWC120 5036					
Flush: Low Credenza: 60.5h oa	36.6	2	DZMWD78 4361	DZMWD84 4517	DZMWD90 4674	DZMWD96 4829	DZMWD102 4984	DZMWD108 5141	DZMWD114 5294	DZMWD120 5450					
Flush: Credenza: 72.5h oa	42.6	2	DZMWE78 4647	DZMWE84 4822	DZMWE90 4997	DZMWE96 5169	DZMWE102 5343	DZMWE108 5519	DZMWE114 5691	DZMWE120 5866					
Flush: Low Credenza: 72.5h oa	48.6	2	DZMWF78 4932	DZMWF84 5124	DZMWF90 5318	DZMWF96 5509	DZMWF102 5705	DZMWF108 5897	DZMWF114 6089	DZMWF120 6282					
Flush: Credenza: 84.5h oa	54.6	3	DZMWG78 5219	DZMWG84 5430	DZMWG90 5643	DZMWG96 5852	DZMWG102 6065	DZMWG108 6275	DZMWG114 6485	DZMWG120 6698					
Flush: Low Credenza: 84.5h oa	60.6	3	DZMWH78 5505	DZMWH84 5734	DZMWH90 5965	DZMWH96 6194	DZMWH102 6423	DZMWH108 6654	DZMWH114 6883	DZMWH120 7115					
Floor: Overhead	54.5	3	DZMWJ78 5219	DZMWJ84 5430	DZMWJ90 5643	DZMWJ96 5852	DZMWJ102 6065	DZMWJ108 6275	DZMWJ114 6485	DZMWJ120 6698					
Floor: 60.5h oa	60	4	DZMWK78 5505	DZMWK84 5734	DZMWK90 5965	DZMWK96 6194	DZMWK102 6423	DZMWK108 6654	DZMWK114 6883	DZMWK120 7115					
Floor: 72.5h oa	72	4													
Floor: 84.5h oa	84	5													

! Notes—for Wall Panels and Shelves:
 All panels are magnetic or tackable.
 1.5-in metal edge on 2 sides on all panels; plus top trim when not below a hutch; plus bottom trim when not on worksurface.

Fabric panels width will be determined by fabric direction.
 Fabric panels over 96 inches wide will be two piece.
 Wall panels taller than 48.6h will be done in multiple sections to fit direction and size of Fabric roll.
 Any Fabric wall panel wider than 96w will be split vertically in two pieces.
 Matte BPGlass (Back-Painted) is Writable; specify (GMB) Black or (GMW) White.
 Max size of glass panels is 96w x 48h in one piece; max width is 96w.
 Shelf depth is 12d on both wood and metal shelves.
 Metal shelves are standard MRBAS, Brushed Aluminum w/Steel Tint.
 Number of shelves is determined by panel size.
 Metal shelves have a weight limit of 40 lbs per linear foot with a .25 inch drop.
 Wood shelves have a weight limit of 40 lbs per linear foot.
 Metal and Wood cannot be intermixed on a single panel.
 Specify shelf location using chart at bottom of section.

Options:
 Specify metal edge finish from standard powder coat colors.
 (MRB) Resin Black (MRS) Resin Satin Aluminum
 (MRBM) Resin Matte Black (MRTG) Resin Thunder Gray
 (MRBZ) Resin Bronze (MRW) Resin White
 (MRDBZ) Resin Dark Bronze
 For (MRBAS) Resin Brushed Aluminum w/ Steel Tint specify MRBAS; no price change.

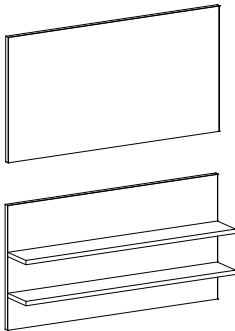

Description	#Shelves	Product No.	List \$	Product No.	List \$	Product No.	List \$	Product No.	List \$	Product No.	List \$	Product No.	List \$	Product No.	List \$
Wall Panels, Matte BPGlass															
	h	30w	36w	42w	48w	54w	60w	66w	72w						
Flush: Credenza: Hutch	25.1	1	DZMGA30 3306	DZMGA36 3534	DZMGA42 3767	DZMGA48 3996	DZMGA54 4226	DZMGA60 4455	DZMGA66 4684	DZMGA72 4916					
Flush: Low Credenza: Hutch	31.1	1	DZMGB30 3632	DZMGB36 3917	DZMGB42 4198	DZMGB48 4482	DZMGB54 4765	DZMGB60 5048	DZMGB66 5331	DZMGB72 5613					
Flush: Credenza: 60.5h oa	30.6	2	DZMGC30 3525	DZMGC36 3789	DZMGC42 4055	DZMGC48 4321	DZMGC54 4585	DZMGC60 4851	DZMGC66 5117	DZMGC72 5381					
Flush: Low Credenza: 60.5h oa	36.6	2	DZMGD30 3851	DZMGD36 4170	DZMGD42 4486	DZMGD48 4806	DZMGD54 5123	DZMGD60 5443	DZMGD66 5761	DZMGD72 6080					
Flush: Credenza: 72.5h oa	42.6	2	DZMGE30 4176	DZMGE36 4548	DZMGE42 4921	DZMGE48 5293	DZMGE54 5665	DZMGE60 6035	DZMGE66 6408	DZMGE72 6778					
Flush: Low Credenza: 72.5h oa	48.6	2	DZMGF30 4505	DZMGF36 4929	DZMGF42 5355	DZMGF48 5779	DZMGF54 6202	DZMGF60 6629	DZMGF66 7053	DZMGF72 7476					
Flush: Credenza: 84.5h oa	54.6	3	DZMGG30 4831	DZMGG36 5310	DZMGG42 5787	DZMGG48 6265	DZMGG54 6741	DZMGG60 7220	DZMGG66 7695	DZMGG72 8174					
Flush: Low Credenza: 84.5h oa	60.6	3	DZMGH30 5160	DZMGH36 5690	DZMGH42 6221	DZMGH48 6752	DZMGH54 7282	DZMGH60 7812	DZMGH66 8343	DZMGH72 8874					
Floor: Overhead	54.5	3	DZMGJ30 4831	DZMGJ36 5310	DZMGJ42 5787	DZMGJ48 6265	DZMGJ54 6741	DZMGJ60 7220	DZMGJ66 7695	DZMGJ72 8174					
Floor: 60.5h oa	60	4	DZMGK30 5160	DZMGK36 5690	DZMGK42 6221	DZMGK48 6752	DZMGK54 7282	DZMGK60 7812	DZMGK66 8343	DZMGK72 8874					
Floor: 72.5h oa	72	4	DZMGL30 5813	DZMGL36 6451	DZMGL42 7085	DZMGL48 7724	DZMGL54 8359	DZMGL60 8996							
Floor: 84.5h oa	84	5	DZMGM30 6468	DZMGM36 7208	DZMGM42 7952	DZMGM48 8696	DZMGM54 9438	DZMGM60 10182							
	h	78w	84w	90w	96w	102w	108w	114w	120w						
Flush: Credenza: Hutch	25.1	1	DZMGA78 5144	DZMGA84 5375	DZMGA90 5605	DZMGA96 5837									
Flush: Low Credenza: Hutch	31.1	1	DZMGB78 5897	DZMGB84 6180	DZMGB90 6463	DZMGB96 6745									
Flush: Credenza: 60.5h oa	30.6	2	DZMGC78 5648	DZMGC84 5912	DZMGC90 6177	DZMGC96 6443									
Flush: Low Credenza: 60.5h oa	36.6	2	DZMGD78 6398	DZMGD84 6717	DZMGD90 7036	DZMGD96 7352									
Flush: Credenza: 72.5h oa	42.6	2	DZMGE78 7149	DZMGE84 7521	DZMGE90 7892	DZMGE96 8265									
Flush: Low Credenza: 72.5h oa	48.6	2	DZMGF78 7902	DZMGF84 8328											
Flush: Credenza: 84.5h oa	54.6	3	DZMGG78 8653	DZMGG84 9129											
Flush: Low Credenza: 84.5h oa	60.6	3	DZMGH78 9405	DZMGH84 9936											
Floor: Overhead	54.5	3	DZMGJ78 8653	DZMGJ84 9129											
Floor: 60.5h oa	60	4	DZMGK78 9405	DZMGK84 9936											
Floor: 72.5h oa	72	4													
Floor: 84.5h oa	84	5													

! Notes—for Wall Panels and Shelves:
 All panels are magnetic or tackable.
 1.5-in metal edge on 2 sides on all panels; plus top trim when not below a hutch; plus bottom trim when not on worksurface.
 Fabric panels width will be determined by fabric direction.
 Fabric panels over 96 inches wide will be two piece.
 Wall panels taller than 48.6h will be done in multiple sections to fit direction and size of Fabric roll.
 Any Fabric wall panel wider than 96w will be split vertically in two pieces.
 Matte BPGlass (Back-Painted) is Writable; specify (GMB) Black or (GMW) White.
 Max size of glass panels is 96w x 48h in one piece; max width is 96w.
 Shelf depth is 12d on both wood and metal shelves.
 Metal shelves are standard MRBAS, Brushed Aluminum w/Steel Tint.
 Number of shelves is determined by panel size.
 Metal shelves have a weight limit of 40 lbs per linear foot with a .25 inch drop.
 Wood shelves have a weight limit of 40 lbs per linear foot.
 Metal and Wood cannot be intermixed on a single panel.
 Specify shelf location using chart at bottom of section.

- + Options:
 Specify metal edge finish from standard powder coat colors.
- | | |
|---------------------------|----------------------------|
| (MRB) Resin Black | (MRS) Resin Satin Aluminum |
| (MRBM) Resin Matte Black | (MRTG) Resin Thunder Gray |
| (MRBZ) Resin Bronze | (MRW) Resin White |
| (MRDBZ) Resin Dark Bronze | |
- For (MRBAS) Resin Brushed Aluminum w/ Steel Tint specify MRBAS; no price change.

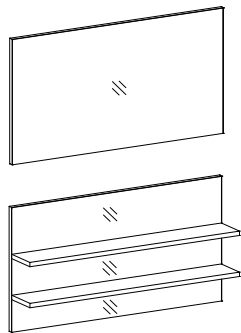

Description	#Shelves	Product No.	List \$	Product No.	List \$	Product No.	List \$	Product No.	List \$	Product No.	List \$	Product No.	List \$	Product No.	List \$	Product No.	List \$	
Wall Panels, Fabric																		
	h	30w	36w	42w	48w	54w	60w	66w	72w									
Flush: Credenza: Hutch	25.1	1	DZMFA30	2455	DZMFA36	2475	DZMFA42	2494	DZMFA48	2514	DZMFA54	2531	DZMFA60	2549	DZMFA66	2569	DZMFA72	2587
Flush: Low Credenza: Hutch	31.1	1	DZMFB30	2540	DZMFB36	2563	DZMFB42	2585	DZMFB48	2608	DZMFB54	2633	DZMFB60	2659	DZMFB66	2681	DZMFB72	2705
Flush: Credenza: 60.5h oa	30.6	2	DZMFC30	2510	DZMFC36	2534	DZMFC42	2555	DZMFC48	2577	DZMFC54	2600	DZMFC60	2622	DZMFC66	2644	DZMFC72	2665
Flush: Low Credenza: 60.5h oa	36.6	2	DZMFD30	2596	DZMFD36	2622	DZMFD42	2646	DZMFD48	2674	DZMFD54	2703	DZMFD60	2727	DZMFD66	2755	DZMFD72	2781
Flush: Credenza: 72.5h oa	42.6	2	DZMFE30	2680	DZMFE36	2709	DZMFE42	2741	DZMFE48	2771	DZMFE54	2801	DZMFE60	2832	DZMFE66	2863	DZMFE72	2894
Flush: Low Credenza: 72.5h oa	48.6	2	DZMFF30	2762	DZMFF36	2798	DZMFF42	2832	DZMFF48	2868	DZMFF54	2902	DZMFF60	2938	DZMFF66	2974	DZMFF72	3010
Flush: Credenza: 84.5h oa	54.6	3	DZMFG30	2847	DZMFG36	2886	DZMFG42	2925	DZMFG48	2964	DZMFG54	3005	DZMFG60	3045	DZMFG66	3084	DZMFG72	3124
Flush: Low Credenza: 84.5h oa	60.6	3	DZMFH30	2930	DZMFH36	2973	DZMFH42	3018	DZMFH48	3062	DZMFH54	3107	DZMFH60	3150	DZMFH66	3194	DZMFH72	3239
Floor: Overhead	54.5	3	DZMFJ30	2847	DZMFJ36	2886	DZMFJ42	2925	DZMFJ48	2964	DZMFJ54	3005	DZMFJ60	3045	DZMFJ66	3084	DZMFJ72	3124
Floor: 60.5h oa	60	4	DZMFK30	2930	DZMFK36	2973	DZMFK42	3018	DZMFK48	3062	DZMFK54	—	—	—	—	—	—	—
Floor: 72.5h oa	72	4	DZMFL30	3095	DZMFL36	3149	DZMFL42	3204	DZMFL48	3255	DZMFL54	—	—	—	—	—	—	—
Floor: 84.5h oa	84	5	DZMFM30	3264	DZMFM36	3326	DZMFM42	3388	DZMFM48	3449	DZMFM54	—	—	—	—	—	—	—
	h	78w	84w	90w	96w	102w	108w	114w	120w									
Flush: Credenza: Hutch	25.1	1	DZMFA78	2607	DZMFA84	2626	DZMFA90	2646	DZMFA96	2666	DZMFA102	2686	DZMFA108	2705	DZMFA114	2725	DZMFA120	2742
Flush: Low Credenza: Hutch	31.1	1	DZMFB78	2727	DZMFB84	2751	DZMFB90	2774	DZMFB96	2798	DZMFB102	2822	DZMFB108	2846	DZMFB114	2868	DZMFB120	2892
Flush: Credenza: 60.5h oa	30.6	2	DZMFC78	2687	DZMFC84	2709	DZMFC90	2731	DZMFC96	2755	DZMFC102	2776	DZMFC108	2798	DZMFC114	2821	DZMFC120	2842
Flush: Low Credenza: 60.5h oa	36.6	2	DZMFD78	2805	DZMFD84	2832	DZMFD90	2861	DZMFD96	2886	DZMFD102	2913	DZMFD108	2940	DZMFD114	2964	DZMFD120	2991
Flush: Credenza: 72.5h oa	42.6	2	DZMFE78	2925	DZMFE84	2958	DZMFE90	2986	DZMFE96	3019	DZMFE102	3049	DZMFE108	3081	DZMFE114	3110	DZMFE120	3143
Flush: Low Credenza: 72.5h oa	48.6	2	DZMFF78	3045	DZMFF84	3081	DZMFF90	3115	DZMFF96	3150	DZMFF102	3187	DZMFF108	3220	DZMFF114	3255	DZMFF120	3292
Flush: Credenza: 84.5h oa	54.6	3	DZMFG78	3166	DZMFG84	3204	DZMFG90	3243	DZMFG96	3283	DZMFG102	3324	DZMFG108	3363	DZMFG114	3402	DZMFG120	3442
Flush: Low Credenza: 84.5h oa	60.6	3	DZMFH78	3283	DZMFH84	3329	DZMFH90	3371	DZMFH96	3414	DZMFH102	3459	DZMFH108	3504	DZMFH114	3549	DZMFH120	3591
Floor: Overhead	54.5	3	DZMFJ78	3166	DZMFJ84	3204	DZMFJ90	3243	DZMFJ96	3283	DZMFJ102	3324	DZMFJ108	3363	DZMFJ114	3402	DZMFJ120	3442
Floor: 60.5h oa	60	4	—	—	—	—	—	—	—	—	—	—	—	—	—	—	—	—
Floor: 72.5h oa	72	4	—	—	—	—	—	—	—	—	—	—	—	—	—	—	—	—
Floor: 84.5h oa	84	5	—	—	—	—	—	—	—	—	—	—	—	—	—	—	—	—

COM Fabric Requirements (yards of 54w material)

	30w	36w	48w	54w	60w	66w	72w	78w	84w	90w	96w	102w	108w	114w	120w
25.1	1	1.2	1.5	1.7	1.9	2.2	2.2	2.4	2.5	2.7	2.9	3.2	3.4	3.5	3.7
31.1	1	1.2	1.5	1.7	1.9	2.2	2.2	2.4	2.5	2.7	2.9	3.2	3.4	3.5	3.7
30.6	2	2.4	3	3.4	3.8	4.4	4.4	4.8	5	5.4	5.8	6.4	6.8	7	7.4
36.6	2	2.4	3	3.4	3.8	4.4	4.4	4.8	5	5.4	5.8	6.4	6.8	7	7.4
42.6	2	2.4	3	3.4	3.8	4.4	4.4	4.8	5	5.4	5.8	6.4	6.8	7	7.4
48.6	2	2.4	3	3.4	3.8	4.4	4.4	4.8	5	5.4	5.8	6.4	6.8	7	7.4
54.6	2	2.4	3	3.4	3.8	4.4	4.4	4.8	5	5.4	5.8	6.4	6.8	7	7.4
60.6	2	2.4	3	3.4	3.8	4.4	4.4	4.8	5	5.4	5.8	6.4	6.8	7	7.4
54.5	2	2.4	3	3.4	3.8	4.4	4.4	4.8	5	5.4	5.8	6.4	6.8	7	7.4
60	2	2.4	3	3.4	3.8	4.4	4.4	4.8	5	5.4	5.8	6.4	6.8	7	7.4
72	3	3.6	4.5	5.1	5.7	6.6	6.6	7.2	7.5	8.1	8.7	9.6	10.2	10.5	11.1
84	3	3.6	4.5	5.1	5.7	6.6	6.6	7.2	7.5	8.1	8.7	9.6	10.2	10.5	11.1

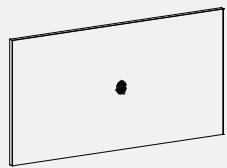

See Notes on the following page for specification information.

Shelves

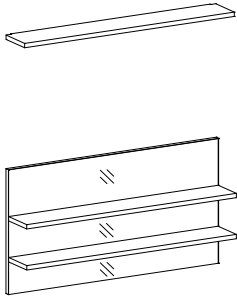

Description	Wood 1.5th		Metal 0.25th	
	Product No.	List \$	Product No.	List \$
Shelf 30w 12d	DZMSW30	1230	DZMSM30	1324
Shelf 36w 12d	DZMSW36	1273	DZMSM36	1412
Shelf 48w 12d	DZMSW48	1446	DZMSM48	1530
Shelf 54w 12d	DZMSW54	1490	DZMSM54	1530
Shelf 60w 12d	DZMSW60	1616	DZMSM60	1530
Shelf 66w 12d	DZMSW66	1660	DZMSM66	1618
Shelf 72w 12d	DZMSW72	1703	DZMSM72	1618
Shelf 78w 12d	DZMSW78	1831	DZMSM78	1618
Shelf 84w 12d	DZMSW84	1876	DZMSM84	1707
Shelf 90w 12d	DZMSW90	1920	DZMSM90	1707
Shelf 96w 12d	DZMSW96	2046	DZMSM96	1972
Shelf 102w 12d	DZMSW102	2092	DZMSM102	1972
Shelf 108w 12d	DZMSW108	2136	DZMSM108	1972
Shelf 114w 12d	DZMSW114	2263	DZMSM114	2032
Shelf 120w 12d	DZMSW120	2309	DZMSM120	2032

! Notes—for Wall Panels and Shelves:

- All panels are magnetic or tackable.
- 1.5-in metal edge on 2 sides on all panels; plus top trim when not below a hutch; plus bottom trim when not on worksurface.
- Fabric panels width will be determined by fabric direction.
- Fabric panels over 96 inches wide will be two piece.
- Wall panels taller than 48.6h will be done in multiple sections to fit direction and size of Fabric roll.
- Any Fabric wall panel wider than 96w will be split vertically in two pieces.
- Matte BPGlass (Back-Painted) is Writable; specify (GMB) Black or (GMW) White.
- Max size of glass panels is 96w x 48h in one piece; max width is 96w.
- Shelf depth is 12d on both wood and metal shelves.
- Metal shelves are standard MRBAS, Brushed Aluminum w/Steel Tint.
- Number of shelves is determined by panel size.
- Metal shelves have a weight limit of 40 lbs per linear foot with a .25 inch drop.
- Wood shelves have a weight limit of 40 lbs per linear foot.
- Metal and Wood cannot be intermixed on a single panel.
- Specify shelf location using chart at bottom of section.

+ Options:

- Specify metal shelf finish from standard powder coat colors.
 - (MRB) Resin Black (MRSA) Resin Satin Aluminum
 - (MRBM) Resin Matte Black (MRTG) Resin Thunder Gray
 - (MRBZ) Resin Bronze (MRW) Resin White
 - (MRDBZ) Resin Dark Bronze
- For (MRBAS) Resin Brushed Aluminum w/ Steel Tint Subtop Trim specify MRBAS; no price change.

Towers Lateral Files

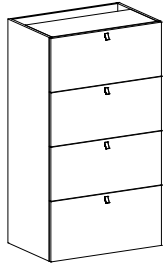

Description	Product No.	List \$	Product No.	List \$
	20d		24d	
Tower	DZTLA	sum	DZTLB	sum
Tower with Toe Kick	DZTLATK	sum	DZTLBTK	sum
	Spec Code Wood1 Faces	▲	Spec Code Wood1 Faces	▲
LatFile 3-High 24w 41.5h	3H24	3449	3H24	3742
LatFile 3-High 30w 41.5h	3H30	3674	3H30	3971
LatFile 3-High 36w 41.5h	3H36	3817	3H36	4117
LatFile 4-High 24w 54.75h	4H24	3951	4H24	4335
LatFile 4-High 30w 54.75h	4H30	4247	4H30	4638
LatFile 4-High 36w 54.75h	4H36	4431	4H36	4824

! Notes:

File towers must be anchored to wall or back to back.
 Tower tops are unfinished, top must be purchased from top chart above.
 Toe kick finish is (MRBAS) Brushed Aluminum w/Steel tint; for polished specify (MPA) Polished Aluminum.
 Pull finish is (MRBAS) Brushed Aluminum w/Steel tint; for polished specify (MPA) Polished Aluminum.
 For Drawer locks, specify LG add \$290.

Towers 60.5h

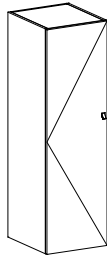
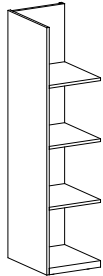
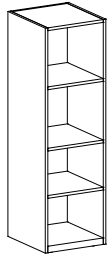

Description	Product No.	List \$	Product No.	List \$
	20d		24d	
Tower 60.5	DZT60A	sum	DZT60B	sum
Tower 60.5 with Toe Kick	DZT60ATK	sum	DZT60BTK	sum

	Spec Code		Spec Code		Spec Code	Add \$
	Wood1 Faces	▲	Wood1 Faces	▲	Light	
Shelving 16w	A16	3014	A16	3410	LED	422
• Shelving 18w	A18	3091	A18	3506	LED	422
Shelving 20w	A20	3210	A20	3645	LED	422
Shelving 24w	A24	3346	A24	3820	LED	422
Shelving 30w	A30	3598	A30	4135	LED	422
Shelving 36w	A36	3854	A36	4450	LED	422
Corner Shelving 16w LH	BL16	2660	BL16	2934	—	—
Corner Shelving 16w RH	BR16	2660	BR16	2934	—	—
Corner Shelving 18w LH	BL18	2735	BL18	3030	—	—
Corner Shelving 18w RH	BR18	2735	BR18	3030	—	—
Corner Shelving 20w LH	BL20	2853	BL20	3170	—	—
• Corner Shelving 20w RH	BR20	2853	BR20	3170	—	—
Cabinet 16w LH	CL16	3283	CL16	3678	—	—
Cabinet 16w RH	CR16	3283	CR16	3678	—	—
• Cabinet 18w LH	CL18	3421	CL18	3837	—	—
Cabinet 18w RH	CR18	3421	CR18	3837	—	—
Cabinet 20w LH	CL20	3595	CL20	4033	—	—
Cabinet 20w RH	CR20	3595	CR20	4033	—	—
Cabinet 24w LH	CL24	3844	CL24	4320	—	—
Cabinet 24w RH	CR24	3844	CR24	4320	—	—
Cabinet 30w DBL	C30	4038	C30	4515	—	—
Cabinet 36w DBL	C36	4235	C36	4709	—	—

(listing continued on following page)

! Notes:

- All units have unfinished backs.
- LH and RH designations indicate hinge side on the single door units.
- 60.5 units have finished tops, all other heights have unfinished tops.
- Corner shelving units must be secured to wall with cleat provided, or to adjoining units (i.e., pedestals or towers).
- Toe kick finish is (MRBAS) Brushed Aluminum w/Steel tint; for polished specify (MPA) Polished Aluminum.
- Pull finish is (MRBAS) Brushed Aluminum w/Steel tint; for polished specify (MPA) Polished Aluminum.

+ Options:

- To specify Lights add LED to spec code and add \$ amount to total.
- For Door/Cabinet locks, specify LD; add \$244.
- For Drawer locks, specify LG add \$290.

Towers 60.5h (continued)

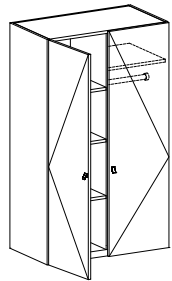
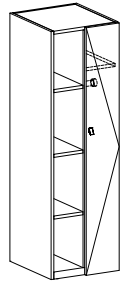

Description	Product No.		List \$		Product No.		List \$			
	20d		24d		20d		24d			
	Spec Code	Wood1	Faces	▲	Spec Code	Wood1	Faces	▲		
					Spec Code	Mirror		Add \$		
Grmt8:Shv8 16w LH	DL16		3520		DL16		4035		MR	—
Shv8:Grmt8 16w RH	DR16		3520		DR16		4035		MR	—
Grmt9:Shv9 18w LH	DL18		3620		DL18		4143		MR	—
• Shv9:Grmt9 18w RH	DR18		3620		DR18		4143		MR	—
Grmt10:Shv10 20w LH	DL20		3705		DL20		4235		MR	—
Shv10:Grmt10 20w RH	DR20		3705		DR20		4235		MR	—
Grmt12:Shv12 24w LH	DL24		3770		DL24		4316		MR	—
Shv12:Grmt12 24w RH	DR24		3770		DR24		4316		MR	—
Grmt15:Shv15 30w LH	DL30		4058		DL30		4637		MR	+177
Shv15:Grmt15 30w RH	DR30		4058		DR30		4637		MR	+177
Grmt18:Shv18 36w LH	DL36		4183		DL36		4776		MR	+287
Shv18:Grmt18 36w RH	DR36		4183		DR36		4776		MR	+287
Grmt8:Cab8 16w LH	EL16		3662		EL16		4153		MR	+145
Cab8:Grmt8 16w RH	ER16		3662		ER16		4153		MR	+145
Grmt9:Cab9 18w LH	EL18		3741		EL18		4262		MR	+162
Cab9:Grmt9 18w RH	ER18		3741		ER18		4262		MR	+162
Grmt10:Cab10 20w LH	EL20		3882		EL20		4293		MR	+181
Cab10:Grmt10 20w RH	ER20		3882		ER20		4293		MR	+181
Grmt12:Cab12 24w DBL	EA24		4058		EA24		4605		MR	—
Cab12:Grmt12 24w DBL	EB24		4058		EB24		4605		MR	—
Grmt15:Cab15 30w DBL	EA30		4254		EA30		4926		MR	+270
Cab15:Grmt15 30w DBL	EB30		4254		EB30		4926		MR	+270
Grmt18:Cab18 36w DBL	EA36		4447		EA36		5121		MR	+287
• Cab18:Grmt18 36w DBL	EB36		4447		EB36		5121		MR	+287

(listing continued on following page)

! Notes:

- All units have unfinished backs.
- LH and RH designations indicate hinge side on the single door units.
- 60.5 units have finished tops, all other heights have unfinished tops.
- Corner shelving units must be secured to wall with cleat provided, or to adjoining units (i.e., pedestals or towers).
- Toe kick finish is (MRBAS) Brushed Aluminum w/Steel tint; for polished specify (MPA) Polished Aluminum.
- Pull finish is (MRBAS) Brushed Aluminum w/Steel tint; for polished specify (MPA) Polished Aluminum.

+ Options:

- To specify mirror add MR to spec code and add \$ amount to total.
- For Door/Cabinet locks, specify LD; add \$244.
- For Drawer locks, specify LG add \$290.

Towers 60.5h (continued)

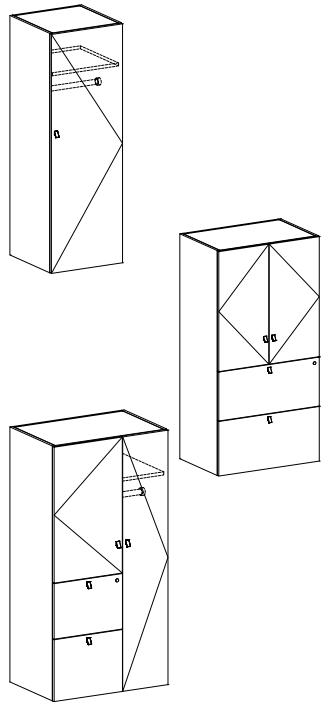

Description	Product No.		List \$		Product No.	List \$		
	20d					24d		
	Spec Code	Wood1 Faces	▲	Spec Code	Wood1 Faces	▲	Spec Code	Add \$
							Mirror	
Garment 16w LH	GL16		3091	GL16		3426	MR	+145
Garment 16w RH	GR16		3091	GR16		3426	MR	+145
Garment 18w LH	GL18		3205	GL18		3550	MR	+162
Garment 18w RH	GR18		3205	GR18		3550	MR	+162
Garment 20w LH	GL20		3360	GL20		3714	MR	+181
• Garment 20w RH	GR20		3360	GR20		3714	MR	+181
Garment 24w LH	GL24		3552	GL24		3910	MR	+216
Garment 24w RH	GR24		3552	GR24		3910	MR	+216
Cab2:2File 16w LH	HL16		3997	HL16		4452	MR	—
Cab2:2File 16w RH	HR16		3997	HR16		4452	MR	—
Cab2:2File 18w LH	HL18		4111	HL18		4542	MR	—
Cab2:2File 18w RH	HR18		4111	HR18		4542	MR	—
Cab2:2File 20w LH	HL20		4290	HL20		4769	MR	—
Cab2:2File 20w RH	HR20		4290	HR20		4769	MR	—
Cab2:2File 24w DBL	H24		4505	H24		5013	MR	—
• Cab2:2File 30w DBL	H30		4782	H30		5294	MR	—
Cab2:2File 36w DBL	H36		5019	H36		5531	MR	—
Cab2/2File 16:Grmt8 24w DBL	JA24		4821	JA24		5442	MR	—
Grmt8:Cab2/2File 16 24w DBL	JB24		4821	JB24		5442	MR	—
Cab2/2File 18:Grmt12 30w DBL	JA30		5018	JA30		5666	MR	+270
Grmt12:Cab2/2File 18 30w DBL	JB30		5018	JB30		5666	MR	+270
• Cab2/2File 18:Grmt18 36w DBL	JA36		5211	JA36		5860	MR	+287
Grmt18:Cab2/2File 18 36w DBL	JB36		5211	JB36		5860	MR	+287

! Notes:

All units have unfinished backs.

LH and RH designations indicate hinge side on the single door units.

60.5 units have finished tops, all other heights have unfinished tops.

Corner shelving units must be secured to wall with cleat provided, or to adjoining units (i.e., pedestals or towers).

Toe kick finish is (MRBAS) Brushed Aluminum w/Steel tint; for polished specify (MPA) Polished Aluminum.

Pull finish is (MRBAS) Brushed Aluminum w/Steel tint; for polished specify (MPA) Polished Aluminum.

+ Options:

To specify mirror add MR to spec code and add \$ amount to total.

For Door/Cabinet locks, specify LD; add \$244.

For Drawer locks, specify LG add \$290.

Towers 72.5h

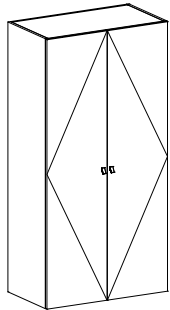
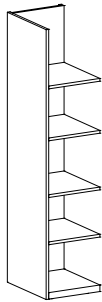
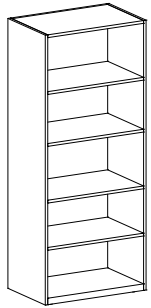

Description	Product No.	List \$	Product No.	List \$		
	20d		24d			
Tower 72.5	DZT72A	sum	DZT72B	sum		
Tower 72.5 with Toe Kick	DZT72ATK	sum	DZT72BTK	sum		
	Spec Code		Spec Code		Spec Code	Add \$
	Wood1 Faces	▲	Wood1 Faces	▲	Light	
Shelving 16w	A16	3414	A16	3889	LED	422
Shelving 18w	A18	3519	A18	4017	LED	422
Shelving 20w	A20	3650	A20	4171	LED	422
Shelving 24w	A24	3821	A24	4394	LED	422
• Shelving 30w	A30	4130	A30	4770	LED	422
Shelving 36w	A36	4436	A36	5147	LED	422
Corner Shelving 16w LH	BL16	2892	BL16	3192	—	—
• Corner Shelving 16w RH	BR16	2892	BR16	3192	—	—
Corner Shelving 18w LH	BL18	2984	BL18	3305	—	—
Corner Shelving 18w RH	BR18	2984	BR18	3305	—	—
Corner Shelving 20w LH	BL20	3103	BL20	3443	—	—
Corner Shelving 20w RH	BR20	3103	BR20	3443	—	—
Cabinet 16w LH	CL16	3657	CL16	4100	—	—
Cabinet 16w RH	CR16	3657	CR16	4100	—	—
Cabinet 18w LH	CL18	3834	CL18	4297	—	—
Cabinet 18w RH	CR18	3834	CR18	4297	—	—
Cabinet 20w LH	CL20	4010	CL20	4493	—	—
Cabinet 20w RH	CR20	4010	CR20	4493	—	—
Cabinet 24w LH	CL24	4309	CL24	4831	—	—
Cabinet 24w RH	CR24	4309	CR24	4831	—	—
• Cabinet 30w DBL	C30	4542	C30	5066	—	—
Cabinet 36w DBL	C36	4778	C36	5300	—	—

(listing continued on following page)

! Notes:

All units have unfinished backs.

LH and RH designations indicate hinge side on the single door units.

72.5h units have unfinished tops.

Corner shelving units must be secured to wall with cleat provided, or to adjoining units (i.e., pedestals or towers).

Toe kick finish is (MRBAS) Brushed Aluminum w/Steel tint; for polished specify (MPA) Polished Aluminum.

Pull finish is (MRBAS) Brushed Aluminum w/Steel tint; for polished specify (MPA) Polished Aluminum.

+ Options:

To specify lights add LED to spec code and add \$ amount to total.

For Door/Cabinet locks, specify LD; add \$244.

For Drawer locks, specify LG add \$290.

Towers 72.5h (continued)

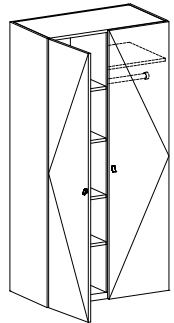
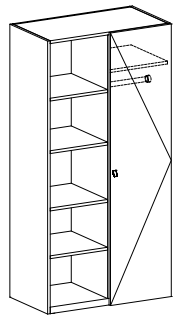

Description	Product No. 20d		Product No. 24d		Spec Code Mirror	Add \$
	Spec Code Wood1 Faces	List \$	Spec Code Wood1 Faces	List \$		
Grmt8:Shv8 16w LH	DL16	4013	DL16	4625	MR	—
Shv8:Grmt8 16w RH	DR16	4013	DR16	4625	MR	—
Grmt9:Shv9 18w LH	DL18	4153	DL18	4770	MR	—
Shv9:Grmt9 18w RH	DR18	4153	DR18	4770	MR	—
Grmt10:Shv10 20w LH	DL20	4236	DL20	4863	MR	—
Shv10:Grmt10 20w RH	DR20	4236	DR20	4863	MR	—
Grmt12:Shv12 24w LH	DL24	4317	DL24	4959	MR	—
• Shv12:Grmt12 24w RH	DR24	4317	DR24	4959	MR	—
Grmt15:Shv15 30w LH	DL30	4669	DL30	5351	MR	+320
Shv15:Grmt15 30w RH	DR30	4669	DR30	5351	MR	+320
Grmt18:Shv18 36w LH	DL36	4821	DL36	5522	MR	+340
Shv18:Grmt18 36w RH	DR36	4821	DR36	5522	MR	+340
Grmt8:Cab8 16w LH	EL16	4182	EL16	4766	MR	+169
Cab8:Grmt8 16w RH	ER16	4182	ER16	4766	MR	+169
Grmt9:Cab9 18w LH	EL18	4297	EL18	4915	MR	+190
Cab9:Grmt9 18w RH	ER18	4297	ER18	4915	MR	+190
Grmt10:Cab10 20w LH	EL20	4438	EL20	5064	MR	+214
Cab10:Grmt10 20w RH	ER20	4438	ER20	5064	MR	+214
Grmt12:Cab12 24w DBL	EA24	4667	EA24	5309	MR	—
Cab12:Grmt12 24w DBL	EB24	4667	EB24	5309	MR	—
Grmt15:Cab15 30w DBL	EA30	4900	EA30	5702	MR	+320
Cab15:Grmt15 30w DBL	EB30	4900	EB30	5702	MR	+320
Grmt18:Cab18 36w DBL	EA36	5135	EA36	5935	MR	+340
• Cab18:Grmt18 36w DBL	EB36	5135	EB36	5935	MR	+340

(listing continued on following page)

! Notes:

- All units have unfinished backs.
- LH and RH designations indicate hinge side on the single door units.
- 72.5h units have unfinished tops.
- Toe kick finish is (MRBAS) Brushed Aluminum w/Steel tint; for polished specify (MPA) Polished Aluminum.
- Pull finish is (MRBAS) Brushed Aluminum w/Steel tint; for polished specify (MPA) Polished Aluminum.

+ Options:

- To specify mirror add MR to spec code and add \$ amount to total.
- For Door/Cabinet locks, specify LD; add \$244.
- For Drawer locks, specify LG add \$290.

Towers 72.5h (continued)

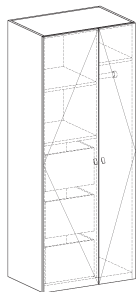
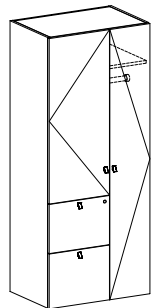
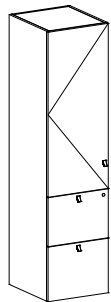
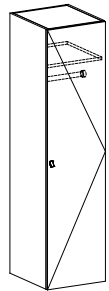

Description	Product No.		List \$		Product No.	List \$	
	20d					24d	
	Spec Code	▲	Spec Code	▲	Spec Code	Add \$	
	Wood1 Faces		Wood1 Faces		Mirror		
Garment 16w LH	GL16	3467	GL16	3846	MR	+169	
Garment 16w RH	GR16	3467	GR16	3846	MR	+169	
Garment 18w LH	GL18	3618	GL18	4010	MR	+190	
• Garment 18w RH	GR18	3618	GR18	4010	MR	+190	
Garment 20w LH	GL20	3773	GL20	4175	MR	+214	
Garment 20w RH	GR20	3773	GR20	4175	MR	+214	
Garment 24w LH	GL24	4007	GL24	4412	MR	+255	
Garment 24w RH	GR24	4007	GR24	4412	MR	+255	
Cab3:2File 16w LH	HL16	4407	HL16	4957	MR	—	
Cab3:2File 16w RH	HR16	4407	HR16	4957	MR	—	
• Cab3:2File 18w LH	HL18	4574	HL18	5101	MR	—	
Cab3:2File 18w RH	HR18	4574	HR18	5101	MR	—	
Cab3:2File 20w LH	HL20	4763	HL20	5343	MR	—	
Cab3:2File 20w RH	HR20	4763	HR20	5343	MR	—	
Cab3:2File 24w DBL	H24	5066	H24	5669	MR	—	
Cab3:2File 30w DBL	H30	5381	H30	5991	MR	—	
Cab3:2File 36w DBL	H36	5657	H36	6267	MR	—	
Cab3/2File 16:Grmt8 24w DBL	JA24	5381	JA24	6098	MR	—	
Grmt8:Cab3/2File 16 24w DBL	JB24	5381	JB24	6098	MR	—	
• Cab3/2File 18:Grmt12 30w DBL	JA30	5618	JA30	6393	MR	+320	
Grmt12:Cab3/2File 18 30w DBL	JB30	5618	JB30	6393	MR	+320	
Cab3/2File 18:Grmt18 36w DBL	JA36	5851	JA36	6629	MR	+340	
Grmt18:Cab3/2File 18 36w DBL	JB36	5851	JB36	6629	MR	+340	
Grmt8:Cab2/3File 16 24w LH	KA24	5381	KA24	6098	MR	+255	
Cab2/3File 16:Grmt8 24w RH	KB24	5381	KB24	6098	MR	+255	
Cab2/3File 18:Grmt12 30w DBL	KA30	5618	KA30	6393	MR	+320	
Grmt12:Cab2/3File 18 30w DBL	KB30	5618	KB30	6393	MR	+320	
• Cab2/3File 18:Grmt18 36w DBL	KA36	5851	KA36	6629	MR	+340	
Grmt18:Cab2/3File 18 36w DBL	KB36	5851	KB36	6629	MR	+340	

! Notes:

All units have unfinished backs.

LH and RH designations indicate hinge side on the single door units.

72.5h units have unfinished tops.

Toe kick finish is (MRBAS) Brushed Aluminum w/Steel tint; for polished specify (MPA) Polished Aluminum.

Pull finish is (MRBAS) Brushed Aluminum w/Steel tint; for polished specify (MPA) Polished Aluminum.

Options:

To specify mirror add MR to spec code and add \$ amount to total.

For Door/Cabinet locks, specify LD; add \$244.

For Drawer locks, specify LG add \$290.

Interior drawers on KA/KB towers are birch; for painted black or white interior drawers specify BLK-DRW or WH-DRW and add \$1050.

Towers 84.5h

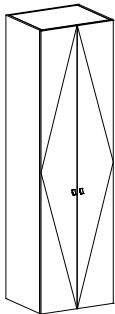
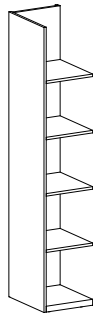
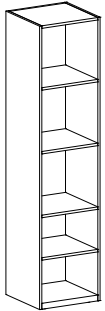

Description	Product No.		List \$		Product No.	List \$	
	20d	24d					
Tower 84.5	DZT84A	sum	DZT84B	sum			
Tower 84.5 with Toe Kick	DZT84ATK	sum	DZT84BTK	sum			
	Spec Code		Spec Code		Spec Code		Add \$
	Wood1 Faces	▲	Wood1 Faces	▲	Light		
Shelving 16w	A16	3951	A16	4475	LED		422
Shelving 18w	A18	4072	A18	4616	LED		422
• Shelving 20w	A20	4198	A20	4770	LED		422
Shelving 24w	A24	4391	A24	5009	LED		422
Shelving 30w	A30	4710	A30	5401	LED		422
Shelving 36w	A36	5031	A36	5792	LED		422
Corner Shelving 16w LH	BL16	3357	BL16	3681	—		—
• Corner Shelving 16w RH	BR16	3357	BR16	3681	—		—
Corner Shelving 18w LH	BL18	3465	BL18	3809	—		—
Corner Shelving 18w RH	BR18	3465	BR18	3809	—		—
Corner Shelving 20w LH	BL20	3584	BL20	3948	—		—
Corner Shelving 20w RH	BR20	3584	BR20	3948	—		—
Cabinet 16w LH	CL16	4079	CL16	4573	—		—
Cabinet 16w RH	CR16	4079	CR16	4573	—		—
Cabinet 18w LH	CL18	4296	CL18	4806	—		—
Cabinet 18w RH	CR18	4296	CR18	4806	—		—
Cabinet 20w LH	CL20	4472	CL20	5003	—		—
Cabinet 20w RH	CR20	4472	CR20	5003	—		—
Cabinet 24w LH	CL24	4809	CL24	5381	—		—
Cabinet 24w RH	CR24	4809	CR24	5381	—		—
• Cabinet 30w DBL	C30	5084	C30	5652	—		—
Cabinet 36w DBL	C36	5357	C36	5928	—		—

(listing continued on following page)

! Notes:

All units have unfinished backs.

LH and RH designations indicate hinge side on the single door units.

84.5h units have unfinished tops.

Corner shelving units must be secured to wall with cleat provided, or to adjoining units (i.e., pedestals or towers).

Toe kick finish is (MRBAS) Brushed Aluminum w/Steel tint; for polished specify (MPA) Polished Aluminum.

Pull finish is (MRBAS) Brushed Aluminum w/Steel tint; for polished specify (MPA) Polished Aluminum.

+ Options:

To specify lights add LED to spec code and add \$ amount to total.

For Door/Cabinet locks, specify LD; add \$244.

For Drawer locks, specify LG add \$290.

Towers 84.5h (continued)

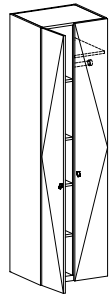
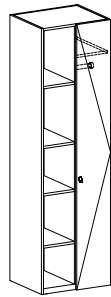

Description	Product No. 20d		Product No. 24d		Spec Code Mirror	Add \$
	Spec Code Wood1 Faces	▲	Spec Code Wood1 Faces	▲		
Grmt8:Shv8 16w LH	DL16	4484	DL16	5166	MR	—
Shv8:Grmt8 16w RH	DR16	4484	DR16	5166	MR	—
Grmt9:Shv9 18w LH	DL18	4664	DL18	5352	MR	—
Shv9:Grmt9 18w RH	DR18	4664	DR18	5352	MR	—
Grmt10:Shv10 20w LH	DL20	4745	DL20	5443	MR	—
Shv10:Grmt10 20w RH	DR20	4745	DR20	5443	MR	—
Grmt12:Shv12 24w LH	DL24	4842	DL24	5555	MR	—
• Shv12:Grmt12 24w RH	DR24	4842	DR24	5555	MR	—
Grmt15:Shv15 30w LH	DL30	5232	DL30	5985	MR	+368
Shv15:Grmt15 30w RH	DR30	5232	DR30	5985	MR	+368
Grmt18:Shv18 36w LH	DL36	5400	DL36	6172	MR	+392
Shv18:Grmt18 36w RH	DR36	5400	DR36	6172	MR	+392
Grmt8:Cab8 16w LH	EL16	4675	EL16	5332	MR	+195
Cab8:Grmt8 16w RH	ER16	4675	ER16	5332	MR	+195
Grmt9:Cab9 18w LH	EL18	4830	EL18	5520	MR	+222
Cab9:Grmt9 18w RH	ER18	4830	ER18	5520	MR	+222
Grmt10:Cab10 20w LH	EL20	4971	EL20	5669	MR	+246
Cab10:Grmt10 20w RH	ER20	4971	ER20	5669	MR	+246
• Grmt12:Cab12 24w DBL	EA24	5240	EA24	5951	MR	—
Cab12:Grmt12 24w DBL	EB24	5240	EB24	5951	MR	—
Grmt15:Cab15 30w DBL	EA30	5511	EA30	6382	MR	+368
Cab15:Grmt15 30w DBL	EB30	5511	EB30	6382	MR	+368
Grmt18:Cab18 36w DBL	EA36	5784	EA36	6655	MR	+392
Cab18:Grmt18 36w DBL	EB36	5784	EB36	6655	MR	+392

(listing continued on following page)

! Notes:

- All units have unfinished backs.
- LH and RH designations indicate hinge side on the single door units.
- 84.5h units have unfinished tops.
- Toe kick finish is (MRBAS) Brushed Aluminum w/Steel tint; for polished specify (MPA) Polished Aluminum.
- Pull finish is (MRBAS) Brushed Aluminum w/Steel tint; for polished specify (MPA) Polished Aluminum.

+ Options:

- To specify mirror add MR to spec code and add \$ amount to total.
- For Door/Cabinet locks, specify LD; add \$244.
- For Drawer locks, specify LG add \$290.

Towers 84.5h (continued)

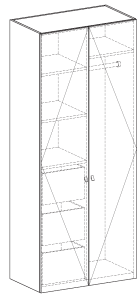
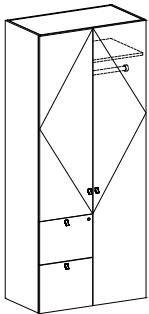
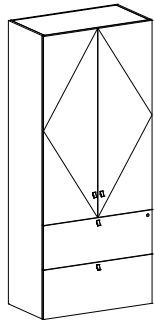
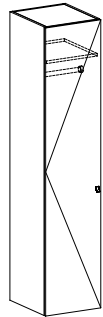

Description	Product No.		List \$		Product No.	List \$	
	20d					24d	
	Spec Code	▲	Spec Code	▲	Spec Code	▲	Add \$
	Wood1 Faces		Wood1 Faces		Mirror		
Garment 16w LH	GL16	3889	GL16	4317	MR		+195
Garment 16w RH	GR16	3889	GR16	4317	MR		+195
• Garment 18w LH	GL18	4079	GL18	4520	MR		+222
Garment 18w RH	GR18	4079	GR18	4520	MR		+222
Garment 20w LH	GL20	4235	GL20	4684	MR		+246
Garment 20w RH	GR20	4235	GR20	4684	MR		+246
Garment 24w LH	GL24	4508	GL24	4959	MR		+294
Garment 24w RH	GR24	4508	GR24	4959	MR		+294
Cab4:2File 16w LH	HL16	4856	HL16	5440	MR		—
Cab4:2File 16w RH	HR16	4856	HR16	5440	MR		—
Cab4:2File 18w LH	HL18	5062	HL18	5624	MR		—
Cab4:2File 18w RH	HR18	5062	HR18	5624	MR		—
Cab4:2File 20w LH	HL20	5251	HL20	5866	MR		—
Cab4:2File 20w RH	HR20	5251	HR20	5866	MR		—
Cab4:2File 24w DBL	H24	5566	H24	6219	MR		—
• Cab4:2File 30w DBL	H30	5921	H30	6577	MR		—
Cab4:2File 36w DBL	H36	6236	H36	6894	MR		—
Cab4/2F 16:Gmt8 24w DBL	JA24	5952	JA24	6743	MR		—
Gmt8:Cab4/2F 16 24w DBL	JB24	5952	JB24	6743	MR		—
Cab4/2F 18:Gmt12 30w DBL	JA30	6230	JA30	7077	MR		+368
Gmt12:Cab4/2F 18 30w DBL	JB30	6230	JB30	7077	MR		+368
• Cab4/2F 18:Gmt18 36w DBL	JA36	6503	JA36	7348	MR		+392
Gmt18:Cab4/2F 18 36w DBL	JB36	6503	JB36	7348	MR		+392
Grmt8:Cab3/3File 16 24w LH	KA24	5952	KA24	6743	MR		+255
Cab3/3File 16:Grmt8 24w RH	KB24	5952	KB24	6743	MR		+255
Cab3/3File 18:Grmt12 30w DBL	KA30	6230	KA30	7077	MR		+320
Grmt12:Cab3/3File 18 30w DBL	KB30	6230	KB30	7077	MR		+320
• Cab3/3File 18:Grmt18 36w DBL	KA36	6503	KA36	7348	MR		+340
Grmt18:Cab3/3File 18 36w DBL	KB36	6503	KB36	7348	MR		+340

! Notes:

All units have unfinished backs.
 LH and RH designations indicate hinge side on the single door units.
 84.5h units have unfinished tops.
 Toe kick finish is (MRBAS) Brushed Aluminum w/Steel tint; for polished specify (MPA) Polished Aluminum.
 Pull finish is (MRBAS) Brushed Aluminum w/Steel tint; for polished specify (MPA) Polished Aluminum.

+ Options:

To specify mirror add MR to spec code and add \$ amount to total.
 For Door/Cabinet locks, specify LD; add \$244.
 For Drawer locks, specify LG add \$290.
 Interior drawers on KA/KB towers are birch; for painted black or white interior drawers specify BLK-DRW or WH-DRW and add \$1050.

