

TUOHY

# Montrose Tables



Conference: **Montrose**

Wood Top	CMO4
HPL Top	CMO5
Solid Surface Top	CMO6
Fenix Top	CMO7
Back-Painted Glass Top	CMO8
Matte Back-Painted Glass Top	CMO9
Marble Top	CMO10
Quartz Top	CMO11

**Overview**

Each Montrose Table may be ordered with 6-inch radius corners or square corners, with one of three base size options, and with power per seat or shared power.

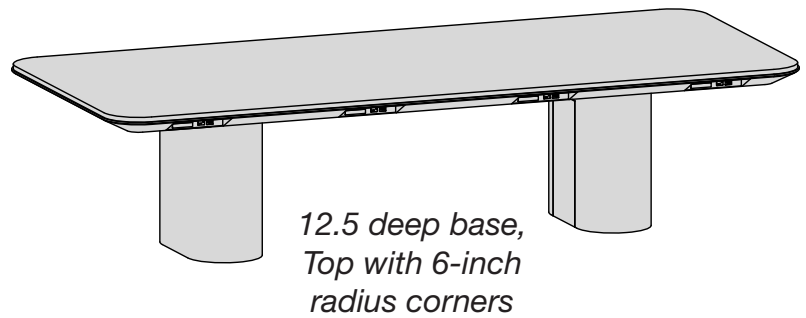
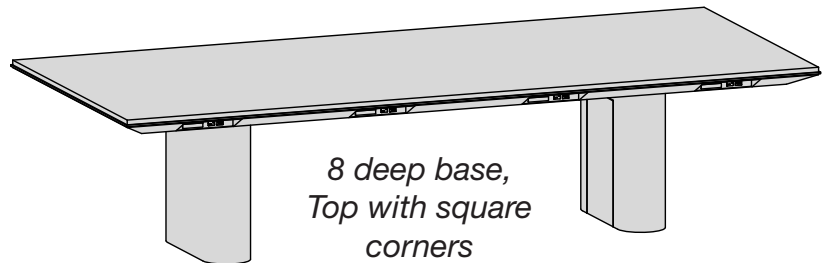
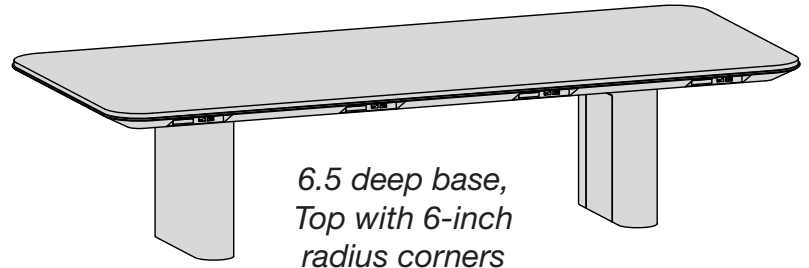

## Sections, Segments, and Power

Table sections are based on power option and width. Top segmentation varies by material. Number of Power Units is based on power option, number of seats and top shape. Individual power option includes one power per seat. Shared power option includes one power per two seats.

### Table Sections by Power Option and Table Width

	90	96	108	120	132	144	156	168	180	192	204	216	240
Individual Power Option	1	1	1	1	3	3	3	3	3	3	3	2	2
Shared Power Option	1	1	1	1	2	3	3	3	3	3	2	2	2

### Top Segments by Material and Table Width

	90	96	108	120	132	144	156	168	180	192	204	216	240
Wood 1 & 2 <small>(all colors; grain long on 1-section tops, short on 2-section tops)</small>	1	1	1	1	2	2	2	2	2	2	2	2	2
HPL Formica® 949 White <small>(PVC as self-edge)</small>	1	1	1	1	2	2	2	2	2	2	2	2	2
Acrylic Solid Surface Avonite® 8016 White, Matte	1	1	1	1	2	2	2	2	2	2	2	2	2
Fenix <small>(30 Bianco Alaska, 718 Grigio Londra, 720 Nero Ingo)</small>	1	1	1	1	2	2	2	2	2	2	2	2	2
Matte BPGlass Back-Painted Glass, Writable <small>(Wood 1 &amp; 2 subtop where applicable)</small>	1	1	1	2	2	2	2	2	2	3	3	3	4
BPGlass Back-Painted Glass <small>(Wood 1 &amp; 2 subtop where applicable)</small>	1	1	1	2	2	2	2	2	2	3	3	3	4
Marble Carrara Marble	2	2	2	2	2	3	3	3	3	4	4	4	5
Quartz <small>(all Cambria® standard colors; quote required for Cambria Matte™ &amp; Luxury Design Series)</small>	2	2	2	2	2	3	3	3	3	4	4	4	5

### Number of Power Units by Power Option and Number of Seats

	90	96	108	120	132	144	156	168	180	192	204	216	240
Individual Power Option													
Rectangle Top	8	8	10	10	12	12	12	14	14	16	16	18	18
Video Top	-	-	-	10	12	12	12	14	14	16	16	18	18
Track Top	10	10	10	12	12	14	14	14	16	16	16	18	18
Shared Power Option													
Rectangle Top	6	6	6	6	8	8	8	8	8	10	10	10	10
Video Top	-	-	-	6	8	8	8	8	8	10	10	10	10
Track Top	5	5	6	6	6	7	7	8	8	8	9	10	10

### Individual Power Option Includes One Power Per Seat

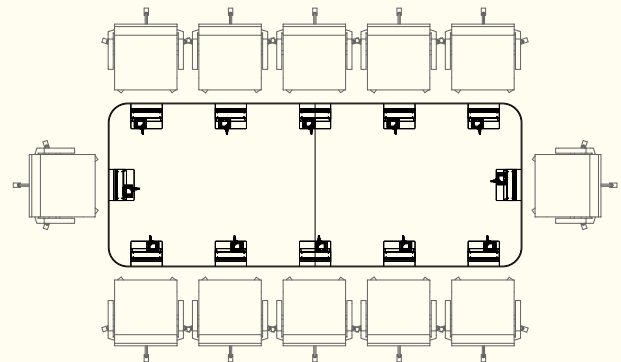

### Shared Power Option Includes One Power Per Two Seats

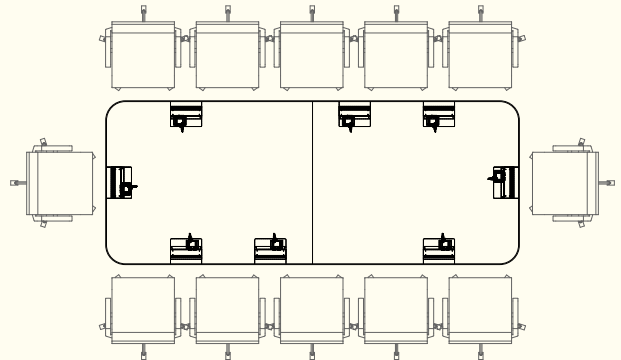

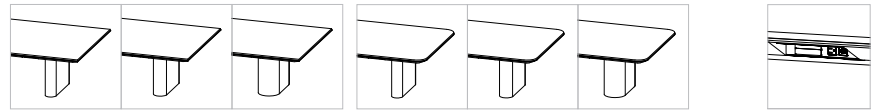

Wood Top, 29.9h ±

Base / Corner Detail Code

Power Options

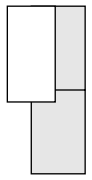
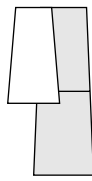
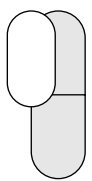
Shape	sections	pcs	w	d	Seats	Prefix & Top Code	Square Corner Detail			Radius Corner Detail, 6-in Radius			1 per Seat	1 per 2 Seats + Ends		
							6.5-in Bases	8-in Bases	12.5-in Bases	6.5-in Bases	8-in Bases	12.5-in Bases				
	1	1	90	48	8	MTW... ...R6...	...S6 21294	...S8 21719	...S12 22146	...R6 22997	...R8 23457	...R12 23918	P 8584	P2 6759		
		1	96	48	8	...R7...	21590	22023	22453	23318	23785	24250	8584	6759		
	2	1	108	48	10	...R8...	22183	22626	23071	23959	24437	24917	10410	8584		
		1	120	52	10	...R9...	24512	25003	25492	26474	27003	27532	10410	8584		
		2	132	52	12	...R10...	25137	25640	26143	27148	27691	28233	12234	10410		
		2	144	52	12	...R11...	29722	30317	30911	32101	32742	33384	12234	10410		
		2	156	56	12	...R12...	32496	33146	33796	35096	35799	36499	12234	10410		
		2	168	56	14	...R13...	33155	33817	34481	35807	36522	37239	14062	12234		
		2	180	56	14	...R14...	33811	34487	35165	36516	37246	37977	14062	12234		
		2	192	60	16	...R15...	35102	35804	36506	37909	38668	39426	15888	14062		
		2	204	60	16	...R16...	39744	40539	41334	42924	43783	44641	15888	14062		
		2	216	60	18	...R17...	40434	41243	42051	43668	44543	45416	17710	15888		
		2	240	60	18	...R18...	41813	42650	43486	45158	46062	46964	17710	15888		
			1	1	120	52/40	10	...V6...	24943	25442	25940	26939	27476	28016	10410	8584
				2	2	132	52/40	12	...V7...	25579	26090	26602	27626	28178	28730	12234
			2	2	144	52/40	12	...V8...	30245	30850	31455	32664	33319	33971	12234	10410
				2	156	56/44	12	...V9...	33069	33730	34392	35715	36429	37144	12234	10410
				2	168	56/44	14	...V10...	33738	34413	35087	36436	37166	37895	14062	12234
2	180			56/44	14	...V11...	34406	35095	35783	37160	37903	38645	14062	12234		
2	192			60/44	16	...V12...	35719	36433	37148	38577	39349	40121	15888	14062		
2	204			60/44	16	...V13...	40443	41252	42061	43679	44553	45425	15888	14062		
2	216			60/44	18	...V14...	41145	41967	42792	44437	45325	46215	17710	15888		
2	240			60/44	18	...V15...	42549	43400	44251	45952	46872	47791	17710	15888		
	1			1	90	48	10	...T6...	21669	22101	22535	—	—	—	10410	8584
				1	96	48	10	...T7...	21970	22410	22849	—	—	—	10410	8584
		1	108	52	10	...T8...	22574	23025	23477	—	—	—	10410	8584		
		1	120	54	12	...T9...	24943	25442	25940	—	—	—	12234	10410		
	2	2	132	54	12	...T10...	25579	26090	26602	—	—	—	12234	10410		
		2	144	54	14	...T11...	30245	30850	31455	—	—	—	14062	12234		
		2	156	60	14	...T12...	33069	33730	34392	—	—	—	14062	12234		
		2	168	60	14	...T13...	33738	34413	35087	—	—	—	14062	12234		
		2	180	60	16	...T14...	34406	35095	35783	—	—	—	15888	14062		
		2	192	60	16	...T15...	35719	36433	37148	—	—	—	15888	14062		
		2	204	60	16	...T16...	40443	41252	42061	—	—	—	15888	14062		
		2	216	60	18	...T17...	41145	41967	42792	—	—	—	17710	15888		
2	240	60	20	...T18...	42549	43400	44251	—	—	—	19536	17710				

To include (1) Power per Seat, append P to end of product number and add list price.    
 To include (1) Power per Every Two Seats + Ends, append P2 to end of product number and add list price. 

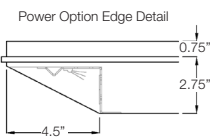
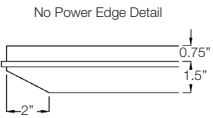

**> To Order:**  
 For product numbers, join the Prefix, Top Code and Base/Corner Detail Code; read across and down for price.  
 Ex. For 90w 48d Rectangle Wood Top, Square Corners, 8-in Bases, w/ Power, Prod No. is MTWR6S8P; list price is \$30303.

**! Notes:**  
 Priced in Wood1  
 Painted Subtop, Black  
 Power option includes set number of power units. See Page CMO3 for qty per table size.  
 Each table end power unit includes (1) simplex, (1) USB-A+C, (1) AAP Blank (1) AAP w/ HDMI.  
 Each table side power unit includes (1) simplex, (1) USB-A+C, (2) AAP Blank.  
 4-trac system, 4 wire, 2 circuit hardwire is standard.  
 72" soft plug infed is available with 20amp plug. UL-Recognized.  
 Chicago Code option: Each station includes one 15A 125V outlet and a 5.2A USB Type-A/Type-C Charger.  
 No whips or cords provided for Chicago Code option.  
 The recessed power area will be illuminated, dimmable, 2700K, 2.5w/ft.



**+ Options:**  
 Specify WB for 12-inch diameter, non-supportive, wire chase base with access panel; add \$2313 to list price.  
 For Wood Tops specify edge finish from following options:  
 Black Polymer (MRBZ) Resin Bronze (MRBAS) Resin Brushed Aluminum w/Steel Tint  
 White Polymer (MRDBZ) Resin Dark Bronze  
 For (MPA) Polished Aluminum, See Customer Service for Custom Pricing. Longer lead times may apply.  
 Specify SP For Soft Plug infed; no price change.  
 Specify CC for Chicago Code option; no price change.

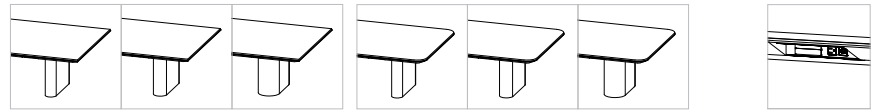

HPL Top, 29.9h ±

Base / Corner Detail Code

Power Options

Shape	sections	pcs	w	d	Seats	Prefix & Top Code	Square Corner Detail			Radius Corner Detail, 6-in Radius			1 per Seat	1 per 2 Seats + Ends		
							6.5-in Bases	8-in Bases	12.5-in Bases	6.5-in Bases	8-in Bases	12.5-in Bases				
	1	1	90	48	8	MTH... ...R6...	...S6 20354	...S8 20762	...S12 21168	...R6 21983	...R8 22422	...R12 22862	P 8584	P2 6759		
		1	96	48	8	...R7...	20638	21050	21463	22289	22734	23180	8584	6759		
	2	1	108	48	10	...R8...	21206	21630	22053	22903	23360	23817	10410	8584		
		1	120	52	10	...R9...	23432	23900	24368	25306	25812	26318	10410	8584		
		2	132	52	12	...R10...	24029	24510	24990	25952	26469	26989	12234	10410		
		2	144	52	12	...R11...	28412	28979	29548	30685	31297	31912	12234	10410		
		2	156	56	12	...R12...	31063	31685	32305	33548	34220	34889	12234	10410		
		2	168	56	14	...R13...	31692	32326	32961	34228	34913	35597	14062	12234		
		2	180	56	14	...R14...	32321	32967	33614	34906	35604	36303	14062	12234		
		2	192	60	16	...R15...	33554	34225	34896	36238	36962	37687	15888	14062		
		2	204	60	16	...R16...	37991	38750	39510	41031	41851	42671	15888	14062		
		2	216	60	18	...R17...	38652	39424	40197	41744	42579	43413	17710	15888		
		2	240	60	18	...R18...	39969	40768	41567	43167	44030	44893	17710	15888		
			1	1	120	52/40	10	...V6...	23842	24320	24797	25750	26266	26780	10410	8584
				2	2	132	52/40	12	...V7...	24451	24941	25429	26408	26937	27464	12234
			2	2	144	52/40	12	...V8...	28911	29488	30068	31224	31848	32473	12234	10410
	2			156	56/44	12	...V9...	31610	32241	32874	34139	34821	35504	12234	10410	
	2			168	56/44	14	...V10...	32250	32894	33539	34830	35526	36223	14062	12234	
2	180			56/44	14	...V11...	32890	33548	34205	35522	36231	36941	14062	12234		
2	192			60/44	16	...V12...	34143	34825	35509	36875	37612	38350	15888	14062		
2	204			60/44	16	...V13...	38659	39432	40206	41752	42586	43422	15888	14062		
2	216			60/44	18	...V14...	39331	40116	40904	42477	43326	44176	17710	15888		
2	240			60/44	18	...V15...	40673	41486	42299	43926	44805	45683	17710	15888		
	1			1	90	48	10	...T6...	20712	21127	21541	—	—	—	10410	8584
				1	96	48	10	...T7...	21001	21422	21842	—	—	—	10410	8584
	2			1	108	52	10	...T8...	21579	22009	22442	—	—	—	10410	8584
				1	120	54	12	...T9...	23842	24320	24797	—	—	—	12234	10410
		2	132	54	12	...T10...	24451	24941	25429	—	—	—	12234	10410		
		2	144	54	14	...T11...	28911	29488	30068	—	—	—	14062	12234		
		2	156	60	14	...T12...	31610	32241	32874	—	—	—	14062	12234		
		2	168	60	14	...T13...	32250	32894	33539	—	—	—	14062	12234		
		2	180	60	16	...T14...	32890	33548	34205	—	—	—	15888	14062		
		2	192	60	16	...T15...	34143	34825	35509	—	—	—	15888	14062		
2	204	60	16	...T16...	38659	39432	40206	—	—	—	15888	14062				
2	216	60	18	...T17...	39331	40116	40904	—	—	—	17710	15888				
2	240	60	20	...T18...	40673	41486	42299	—	—	—	19536	17710				

To include (1) Power per Seat, append P to end of product number and add list price.

To include (1) Power per Every Two Seats + Ends, append P2 to end of product number and add list price.

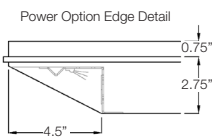
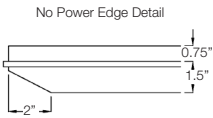

> To Order:  
For product numbers, join the Prefix, Top Code and Base/Corner Detail Code; read across and down for price.  
Ex. For 90w 48d Rectangle HPL Top, Square Corners, 8-in Bases, w/ Power, Prod No. is MTHR6S8P; list price is \$29346.

! Notes:  
HPL Formica® 949 White  
Painted Subtop, Black  
Power option includes set number of power units. See Page CMO3 for qty per table size.  
Each table end power unit includes (1) simplex, (1) USB-A+C, (1) AAP Blank (1) AAP w/ HDMI.  
Each table side power unit includes (1) simplex, (1) USB-A+C, (2) AAP Blank.  
4-trac system, 4 wire, 2 circuit hardwire is standard.  
72" soft plug infed is available with 20amp plug. UL-Recognized.  
Chicago Code option: Each station includes one 15A 125V outlet and a 5.2A USB Type-A/Type-C Charger.  
No whips or cords provided for Chicago Code option.  
The recessed power area will be illuminated, dimmable, 2700K, 2.5w/ft.



+ Options:  
Specify WB for 12-inch diameter, non-supportive, wire chase base with access panel; add \$2313 to list price.  
For Laminate Tops specify edge finish from following options:  
Black Polymer (MRBZ) Resin Bronze (MRBAS) Resin Brushed Aluminum w/Steel Tint  
White Polymer (MRDBZ) Resin Dark Bronze  
For (MPA) Polished Aluminum, See Customer Service for Custom Pricing. Longer lead times may apply.  
Specify SP For Soft Plug infed; no price change.  
Specify CC for Chicago Code option; no price change.

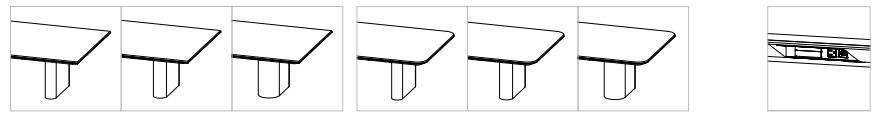

Solid Surface Top, 29.9h ±

Base / Corner Detail Code

Power Options

Shape	sections	pcs	w	d	Seats	Prefix & Top Code	Square Corner Detail			Radius Corner Detail, 6-in Radius			1 per Seat	1 per 2 Seats + Ends						
							6.5-in Bases	8-in Bases	12.5-in Bases	6.5-in Bases	8-in Bases	12.5-in Bases								
	1	1	90	48	8	MTS... ...R6...	...S6 22419	...S8 22867	...S12 23314	...R6 24212	...R8 24696	...R12 25180	P	P2						
			96	48	8	...R7... 22790	23245	23702	24613	25106	25598	8584	6759							
	2	1	108	48	10	...R8... 23533	24004	24474	25416	25925	26433	10410	8584	6759						
			120	52	10	...R9... 26137	26660	27182	28228	28792	29356	10410	8584							
		2	2	132	52	12	...R10... 26926	27465	28004	29081	29661	30244	12234	10410						
				144	52	12	...R11... 31673	32307	32941	34207	34892	35575	12234	10410						
			2	2	156	56	12	...R12... 34611	35303	35995	37379	38128	38875	12234	10410					
					168	56	14	...R13... 35607	36318	37030	38455	39224	39993	14062	12234					
				2	2	180	56	14	...R14... 36440	37169	37898	39355	40143	40929	14062	12234				
						192	60	16	...R15... 38105	38867	39628	41153	41976	42799	15888	14062				
					2	2	204	60	16	...R16... 42935	43793	44652	46369	47297	48224	15888	14062			
							216	60	18	...R17... 43811	44688	45564	47316	48263	49209	17710	15888			
						2	2	240	60	18	...R18... 45567	46478	47389	49211	50197	51180	17710	15888		
								120	52/40	10	...V6... 26568	27099	27631	28693	29267	29841	10410	8584		
							2	2	132	52/40	12	...V7... 27368	27915	28463	29559	30149	30740	12234	10410	
									144	52/40	12	...V8... 32196	32840	33485	34772	35468	36163	12234	10410	
								2	2	156	56/44	12	...V9... 35183	35887	36589	37997	38758	39517	12234	10410
										168	56/44	14	...V10... 36189	36914	37637	39085	39867	40648	14062	12234
2	2	180	56/44	14	...V11... 37036	37776			38517	39998	40798	41599	14062	12234						
		192	60/44	16	...V12... 38722	39496			40271	41820	42656	43492	15888	14062						
	2	2	204	60/44	16	...V13... 43634			44506	45379	47124	48068	49010	15888	14062					
			216	60/44	18	...V14... 44522			45414	46303	48085	49046	50007	17710	15888					
		2	2	240	60/44	18			...V15... 46302	47228	48154	50006	51006	52007	17710	15888				
				90	48	10			...T6... 22793	23248	23705	—	—	—	10410	8584				
			2	1	96	48			10	...T7... 23170	23633	24098	—	—	—	10410	8584			
					108	52			10	...T8... 23923	24402	24880	—	—	—	10410	8584			
				2	1	120			54	12	...T9... 26568	27099	27631	—	—	—	12234	10410		
						132			54	12	...T10... 27368	27915	28463	—	—	—	12234	10410		
					2	2			144	54	14	...T11... 32196	32840	33485	—	—	—	14062	12234	
									156	60	14	...T12... 35183	35887	36589	—	—	—	14062	12234	
2	2	168				60	14	...T13... 36189	36914	37637	—	—	—	14062	12234					
		180				60	16	...T14... 37036	37776	38517	—	—	—	15888	14062					
	2	2				192	60	16	...T15... 38722	39496	40271	—	—	—	15888	14062				
						204	60	16	...T16... 43634	44506	45379	—	—	—	15888	14062				
		2				2	216	60	18	...T17... 44522	45414	46303	—	—	—	17710	15888			
							240	60	20	...T18... 46302	47228	48154	—	—	—	19536	17710			

To include (1) Power per Seat, append P to end of product number and add list price.

To include (1) Power per Every Two Seats + Ends, append P2 to end of product number and add list price.

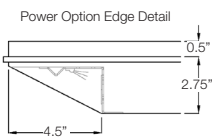
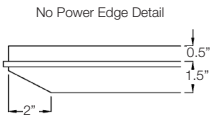

> To Order:  
For product numbers, join the Prefix, Top Code and Base/Corner Detail Code; read across and down for price.  
Ex. For 90w 48d Rectangle SS Top, Square Corners, 8-in Bases, w/ Power, Prod No. is MTSR6S8P; list price is \$31451.

! Notes:  
Solid Surface is Avonite® 8016 White, Matte.  
Painted Subtop, Black  
Power option includes set number of power units. See Page CMO3 for qty per table size.  
Each table end power unit includes (1) simplex, (1) USB-A+C, (1) AAP Blank (1) AAP w/ HDMI.  
Each table side power unit includes (1) simplex, (1) USB-A+C, (2) AAP Blank.  
4-trac system, 4 wire, 2 circuit hardwire is standard.  
72" soft plug infed is available with 20amp plug. UL-Recognized.  
Chicago Code option: Each station includes one 15A 125V outlet and a 5.2A USB Type-A/Type-C Charger.  
No whips or cords provided for Chicago Code option.  
The recessed power area will be illuminated, dimmable, 2700K, 2.5w/ft.



+ Options:  
Specify WB for 12-inch diameter, non-supportive, wire chase base with access panel; add \$2313 to list price.  
For Solid Surface Tops specify metal edge finish from following standard powder coat colors:  
(MRB) Resin Black (MRBZ) Resin Bronze (MRW) Resin White  
(MRBM) Resin Matte Black (MRDBZ) Resin Dark Bronze (MRBAS) Resin Brushed Aluminum w/Steel Tint  
For (MPA) Polished Aluminum, See Customer Service for Custom Pricing. Longer lead times may apply.  
Specify SP For Soft Plug infed; no price change.  
Specify CC for Chicago Code option; no price change.

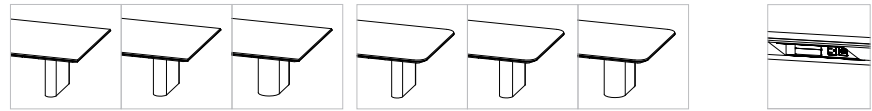

Fenix Top, 29.9h ±

Base / Corner Detail Code

Power Options

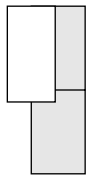
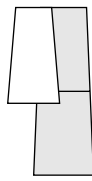
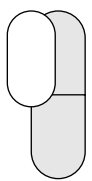
Shape	sections	pcs	w	d	Seats	Prefix & Top Code	Square Corner Detail			Radius Corner Detail, 6-in Radius			1 per Seat	1 per 2 Seats + Ends		
							6.5-in Bases	8-in Bases	12.5-in Bases	6.5-in Bases	8-in Bases	12.5-in Bases				
 Rectangle	1	1	90	48	8	MTF... ...R6...	...S6 23016	...S8 23477	...S12 23937	...R6 24857	...R8 25355	...R12 25851	P 8584	P2 6759		
			96	48	8	...R7... 23424	23894	24362	25299	25805	26311	8584	6759			
	2	2	108	48	10	...R8... 24248	24733	25218	26187	26711	27235	10410	8584			
			120	52	10	...R9... 26961	27500	28039	29118	29699	30282	10410	8584			
			132	52	12	...R10... 27830	28387	28944	30056	30658	31260	12234	10410			
			144	52	12	...R11... 32661	33315	33969	35275	35980	36686	12234	10410			
			156	56	12	...R12... 35680	36394	37108	38535	39306	40077	12234	10410			
			168	56	14	...R13... 36847	37583	38321	39795	40590	41387	14062	12234			
			180	56	14	...R14... 37770	38525	39279	40791	41606	42422	14062	12234			
			192	60	16	...R15... 39623	40416	41208	42793	43650	44504	15888	14062			
			204	60	16	...R16... 44548	45440	46330	48113	49075	50037	15888	14062			
			216	60	18	...R17... 45521	46432	47342	49163	50146	51130	17710	15888			
			240	60	18	...R18... 47465	48414	49364	51262	52287	53313	17710	15888			
			 Video	1	1	120	52/40	10	...V6... 27391	27939	28488	29584	30174	30766	10410	8584
						132	52/40	12	...V7... 28272	28838	29404	30535	31146	31756	12234	10410
				2	2	144	52/40	12	...V8... 33184	33848	34511	35839	36556	37272	12234	10410
						156	56/44	12	...V9... 36252	36978	37702	39153	39936	40719	12234	10410
						168	56/44	14	...V10... 37430	38178	38927	40424	41232	42042	14062	12234
180	56/44	14				...V11... 38365	39132	39900	41434	42264	43091	14062	12234			
192	60/44	16				...V12... 40240	41045	41850	43460	44328	45198	15888	14062			
204	60/44	16				...V13... 45248	46153	47058	48867	49846	50823	15888	14062			
216	60/44	18				...V14... 46233	47158	48082	49931	50930	51928	17710	15888			
240	60/44	18				...V15... 48200	49164	50128	52057	53096	54138	17710	15888			
 Track	1	1				90	48	10	...T6... 23391	23858	24326	—	—	—	10410	8584
						96	48	10	...T7... 23806	24281	24758	—	—	—	10410	8584
	2	2	108	52	10	...T8... 24637	25131	25623	—	—	—	10410	8584			
			120	54	12	...T9... 27391	27939	28488	—	—	—	12234	10410			
			132	54	12	...T10... 28272	28838	29404	—	—	—	12234	10410			
			144	54	14	...T11... 33184	33848	34511	—	—	—	14062	12234			
			156	60	14	...T12... 36252	36978	37702	—	—	—	14062	12234			
			168	60	14	...T13... 37430	38178	38927	—	—	—	14062	12234			
			180	60	16	...T14... 38365	39132	39900	—	—	—	15888	14062			
			192	60	16	...T15... 40240	41045	41850	—	—	—	15888	14062			
204	60	16	...T16... 45248	46153	47058	—	—	—	15888	14062						
216	60	18	...T17... 46233	47158	48082	—	—	—	17710	15888						
240	60	20	...T18... 48200	49164	50128	—	—	—	19536	17710						

To include (1) Power per Seat, append P to end of product number and add list price.    
 To include (1) Power per Every Two Seats + Ends, append P2 to end of product number and add list price. 

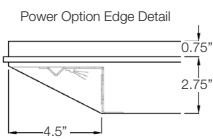
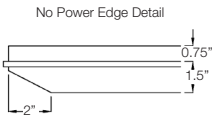

> To Order:  
 For product numbers, join the Prefix, Top Code and Base/Corner Detail Code; read across and down for price.  
 Ex. For 90w 48d Rectangle SS Top, Square Corners, 8-in Bases, w/ Power, Prod No. is MTSR6S8P; list price is \$32061.

! Notes:  
 Fenix: 30 Bianco Alaska, 718 Grigio Londra, or 720 Nero Ingo  
 Painted Subtop, Black  
 Power option includes set number of power units. See Page CMO3 for qty per table size.  
 Each table end power unit includes (1) simplex, (1) USB-A+C, (1) AAP Blank (1) AAP w/ HDMI.  
 Each table side power unit includes (1) simplex, (1) USB-A+C, (2) AAP Blank.  
 4-trac system, 4 wire, 2 circuit hardwire is standard.  
 72" soft plug infed is available with 20amp plug. UL-Recognized.  
 Chicago Code option: Each station includes one 15A 125V outlet and a 5.2A USB Type-A/Type-C Charger.  
 No whips or cords provided for Chicago Code option.  
 The recessed power area will be illuminated, dimmable, 2700K, 2.5w/ft.



+ Options:  
 Specify WB for 12-inch diameter, non-supportive, wire chase base with access panel; add \$2313 to list price.  
 For Fenix Tops specify edge finish from following options:  
 Black Polymer (MRBZ) Resin Bronze (MRBAS) Resin Brushed Aluminum w/Steel Tint  
 White Polymer (MRDBZ) Resin Dark Bronze  
 For (MPA) Polished Aluminum, See Customer Service for Custom Pricing. Longer lead times may apply.  
 Specify SP For Soft Plug infeed; no price change.  
 Specify CC for Chicago Code option; no price change.

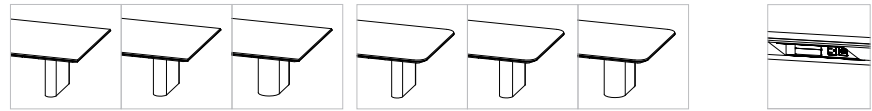

Back-Painted Glass Top, 29.9h ±

Base / Corner Detail Code

Power Options

Shape	sections	pcs	w	d	Seats	Prefix & Top Code	Square Corner Detail			Radius Corner Detail, 6-in Radius			1 per Seat	1 per 2 Seats + Ends		
							6.5-in Bases	8-in Bases	12.5-in Bases	6.5-in Bases	8-in Bases	12.5-in Bases				
	1	1	90	48	8	MTG... ...R6...	...S6 26767	...S8 27302	...S12 27837	...R6 28908	...R8 29486	...R12 30064	P 8584	P2 6759		
			96	48	8	...R7... 27428	27977	28525	29622	30215	30807	8584	6759			
	2	2	108	48	10	...R8... 28751	29327	29901	31051	31672	32294	10410	8584			
			120	52	10	...R9... 32417	33066	33713	35010	35711	36410	10410	8584			
			132	52	12	...R10... 33832	34509	35186	36539	37270	38000	12234	10410			
			144	52	12	...R11... 39208	39992	40777	42344	43192	44039	12234	10410			
			156	56	12	...R12... 42773	43629	44483	46195	47119	48043	12234	10410			
			168	56	14	...R13... 45072	45974	46875	48679	49652	50625	14062	12234			
			180	56	14	...R14... 46582	47514	48445	50309	51315	52320	14062	12234			
			192	60	16	...R15... 49694	50688	51682	53670	54743	55816	15888	14062			
			204	60	16	...R16... 55250	56355	57460	59669	60862	62056	15888	14062			
			216	60	18	...R17... 56851	57988	59126	61400	62627	63856	17710	15888			
			240	60	18	...R18... 60056	61256	62458	64861	66156	67454	17710	15888			
				1	1	120	52/40	10	...V6... 32848	33506	34162	35476	36185	36895	10410	8584
132	52/40	12				...V7... 34274	34961	35646	37017	37757	38498	12234	10410			
2	2	144		52/40	12	...V8... 39731	40526	41320	42909	43768	44625	12234	10410			
		156		56/44	12	...V9... 43345	44211	45079	46812	47748	48685	12234	10410			
		168		56/44	14	...V10... 45656	46569	47481	49308	50294	51280	14062	12234			
		180		56/44	14	...V11... 47178	48120	49064	50951	51971	52989	14062	12234			
		192		60/44	16	...V12... 50312	51318	52324	54336	55424	56510	15888	14062			
		204		60/44	16	...V13... 55948	57068	58187	60424	61633	62841	15888	14062			
		216		60/44	18	...V14... 57563	58714	59865	62167	63411	64654	17710	15888			
		240		60/44	18	...V15... 60791	62007	63223	65654	66967	68282	17710	15888			
				1	1	90	48	10	...T6... 27141	27684	28227	—	—	—	10410	8584
						96	48	10	...T7... 27808	28364	28921	—	—	—	10410	8584
				2	2	108	52	10	...T8... 29142	29724	30306	—	—	—	10410	8584
						120	54	12	...T9... 32848	33506	34162	—	—	—	12234	10410
132	54		12			...T10... 34274	34961	35646	—	—	—	12234	10410			
144	54		14			...T11... 39731	40526	41320	—	—	—	14062	12234			
156	60		14			...T12... 43345	44211	45079	—	—	—	14062	12234			
168	60		14			...T13... 45656	46569	47481	—	—	—	14062	12234			
180	60		16			...T14... 47178	48120	49064	—	—	—	15888	14062			
192	60		16			...T15... 50312	51318	52324	—	—	—	15888	14062			
204	60		16			...T16... 55948	57068	58187	—	—	—	15888	14062			
216	60		18			...T17... 57563	58714	59865	—	—	—	17710	15888			
240	60		20			...T18... 60791	62007	63223	—	—	—	19536	17710			

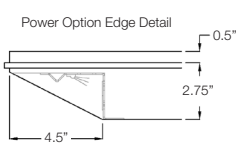
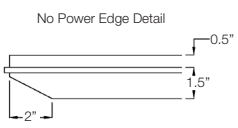

To include (1) Power per Seat, append P to end of product number and add list price.   
 To include (1) Power per Every Two Seats + Ends, append P2 to end of product number and add list price.

> To Order:  
 For product numbers, join the Prefix, Top Code and Base/Corner Detail Code; read across and down for price.  
 Ex. For 90w 48d Rectangle BP Glass Top, Square Corners, 8-in Bases, w/ Power, Prod No. is MTGR6S8P; list price is \$35886.

! Notes:  
 Back-Painted Glass: (S.BLK) Black or (S.BWT) White  
 Painted Subtop, Black  
 Power option includes set number of power units. See Page CMO3 for qty per table size.  
 Each table end power unit includes (1) simplex, (1) USB-A+C, (1) AAP Blank (1) AAP w/ HDMI.  
 Each table side power unit includes (1) simplex, (1) USB-A+C, (2) AAP Blank.  
 4-trac system, 4 wire, 2 circuit hardwire is standard.  
 72" soft plug infed is available with 20amp plug. UL-Recognized.  
 Chicago Code option: Each station includes one 15A 125V outlet and a 5.2A USB Type-A/Type-C Charger.  
 No whips or cords provided for Chicago Code option.  
 The recessed power area will be illuminated, dimmable, 2700K, 2.5w/ft.



+ Options:  
 Specify WB for 12-inch diameter, non-supportive, wire chase base with access panel; add \$2313 to list price.  
 For Glass Tops specify edge finish from following options:  
 Black Polymer (MRBZ) Resin Bronze (MRBAS) Resin Brushed Aluminum w/Steel Tint  
 White Polymer (MRDBZ) Resin Dark Bronze  
 For (MPA) Polished Aluminum, See Customer Service for Custom Pricing. Longer lead times may apply.  
 Specify SP For Soft Plug infed; no price change.  
 Specify CC for Chicago Code option; no price change.

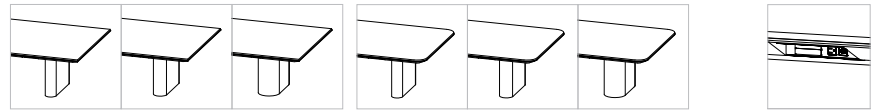



Matte Back-Painted Glass Top, 29.6h ±

Base / Corner Detail Code

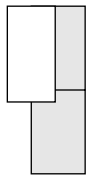
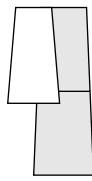
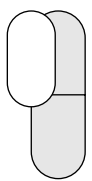
Power Options

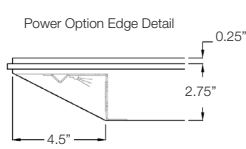
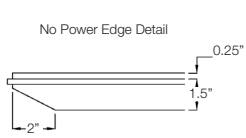
Shape	sections	pcs	w	d	Seats	Prefix & Top Code	Square Corner Detail			Radius Corner Detail, 6-in Radius			1 per Seat	1 per 2 Seats + Ends						
							6.5-in Bases	8-in Bases	12.5-in Bases	6.5-in Bases	8-in Bases	12.5-in Bases								
	1	1	90	48	8	MTJ... ...R6...	...S6 27431	...S8 27980	...S12 28529	...R6 29626	...R8 30218	...R12 30810	P 8584	P2 6759						
			96	48	8	...R7... 28137	28700	29262	30388	30995	31603	8584	6759							
	2	1	108	48	10	...R8... 29549	30140	30731	31913	32551	33189	10410	8584							
						120	52	10	...R9... 33378	34046	34713	36049	36770	37490	10410	8584				
		2	2	132	52	12	...R10... 34889	35588	36286	37681	38434	39188	12234	10410						
							144	52	12	...R11... 40361	41168	41976	43591	44461	45334	12234	10410			
			2	2	156	56	12	...R12... 44021	44902	45782	47543	48494	49445	12234	10410					
								168	56	14	...R13... 47478	48427	49377	51276	52302	53328	14062	12234		
				2	2	180	56	14	...R14... 48135	49098	50060	51987	53026	54065	14062	12234				
									192	60	16	...R15... 51469	52499	53528	55587	56698	57810	15888	14062	
					2	2	204	60	16	...R16... 57135	58277	59421	61705	62939	64174	15888	14062			
										216	60	18	...R17... 58847	60024	61201	63554	64827	66098	17710	15888
						2	2	240	60	18	...R18... 62272	63519	64763	67255	68600	69944	17710	15888		
								1	1	120	52/40	10	...V6... 33809	34485	35162	36514	37244	37974	10410	8584
										132	52/40	12	...V7... 35331	36038	36745	38159	38921	39685	12234	10410
								2	2	144	52/40	12	...V8... 40884	41702	42519	44156	45039	45921	12234	10410
													156	56/44	12	...V9... 44594	45486	46377	48161	49125
2	2	168	56/44	14	...V10... 48062	49022			49984	51906	52944	53983	14062	12234						
					180	56/44			14	...V11... 48731	49705	50679	52629	53682	54733	14062	12234			
	2	2	192	60/44	16	...V12... 52086			53128	54171	56254	57378	58504	15888	14062					
						204			60/44	16	...V13... 57834	58990	60147	62461	63709	64958	15888	14062		
		2	2	216	60/44	18			...V14... 59558	60749	61941	64323	65608	66897	17710	15888				
									240	60/44	18	...V15... 63008	64268	65528	68048	69409	70771	17710	15888	
				1	1	90			48	10	...T6... 27806	28362	28919	—	—	—	10410	8584		
						96			48	10	...T7... 28517	29087	29658	—	—	—	10410	8584		
				2	1	108			52	10	...T8... 29940	30538	31137	—	—	—	10410	8584		
											120	54	12	...T9... 33809	34485	35162	—	—	—	12234
					2	2			132	54	12	...T10... 35331	36038	36745	—	—	—	12234	10410	
144	54	14					...T11... 40884	41702				42519	—	—	—	14062	12234			
2	2	156				60	14	...T12... 44594	45486	46377	—	—	—	14062	12234					
								168	60	14	...T13... 48062	49022	49984	—	—	—	14062	12234		
	2	2				180	60	16	...T14... 48731	49705	50679	—	—	—	15888	14062				
									192	60	16	...T15... 52086	53128	54171	—	—	—	15888	14062	
		2				2	204	60	16	...T16... 57834	58990	60147	—	—	—	15888	14062			
										216	60	18	...T17... 59558	60749	61941	—	—	—	17710	15888
						2	2	240	60	20	...T18... 63008	64268	65528	—	—	—	19536	17710		



To include (1) Power per Seat, append P to end of product number and add list price.    
 To include (1) Power per Every Two Seats + Ends, append P2 to end of product number and add list price.    
 > To Order:   
 For product numbers, join the Prefix, Top Code and Base/Corner Detail Code; read across and down for price.   
 Ex. For 90w 48d Rectangle Matte BPGlass Top, Square Corners, 8-in Bases, w/ Power, Prod No. is MTJR6S8P; list price is \$36564.

! Notes:   
 Matte BPGlass (Back-Painted): Writable; specify (GMB) Black or (GMW) White   
 Painted Subtop, Black   
 Power option includes set number of power units. See Page CMO3 for qty per table size.   
 Each table end power unit includes (1) simplex, (1) USB-A+C, (1) AAP Blank (1) AAP w/ HDMI.   
 Each table side power unit includes (1) simplex, (1) USB-A+C, (2) AAP Blank.   
 4-trac system, 4 wire, 2 circuit hardware is standard.   
 72" soft plug infeed is available with 20amp plug. UL-Recognized.   
 Chicago Code option: Each station includes one 15A 125V outlet and a 5.2A USB Type-A/Type-C Charger.   
 No whips or cords provided for Chicago Code option.   
 The recessed power area will be illuminated, dimmable, 2700K, 2.5w/ft.   
 Options:   
 Specify WB for 12-inch diameter, non-supportive, wire chase base with access panel; add \$2313 to list price.   
 For Glass Tops specify edge finish from following options:   
 Black Polymer (MRBZ) Resin Bronze (MRBAS) Resin Brushed Aluminum w/Steel Tint   
 White Polymer (MRDBZ) Resin Dark Bronze   
 For (MPA) Polished Aluminum, See Customer Service for Custom Pricing. Longer lead times may apply.   
 Specify SP For Soft Plug infeed; no price change.   
 Specify CC for Chicago Code option; no price change.

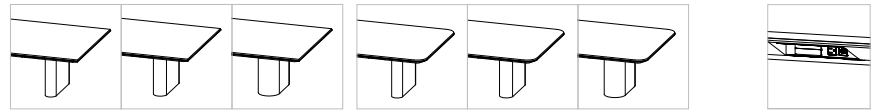

Marble Top, 29.9h ±

Base / Corner Detail Code

Power Options

Shape	sections	pcs	w	d	Seats	Prefix & Top Code	Square Corner Detail			Radius Corner Detail, 6-in Radius			1 per Seat	1 per 2 Seats + Ends						
							6.5-in Bases	8-in Bases	12.5-in Bases	6.5-in Bases	8-in Bases	12.5-in Bases								
	1	1	90	48	8	MTM... ...R6...	...S6 37651	...S8 38404	...S12 39157	...R6 40662	...R8 41476	...R12 42289	P 8584	P2 6759						
			96	48	8	...R7... 39037	39818	40598	42161	43003	43847	8584	6759							
	2	1	108	48	10	...R8... 41811	42647	43484	45156	46059	46962	10410	8584							
			120	52	10	...R9... 48138	49101	50065	51990	53029	54070	10410	8584							
		2	2	132	52	12	...R10... 51127	52148	53171	55216	56320	57425	12234	10410						
				144	52	12	...R11... 58074	59236	60397	62720	63974	65229	12234	10410						
			2	2	156	56	12	...R12... 63212	64476	65739	68269	69635	70999	12234	10410					
					168	56	14	...R13... 68776	70153	71527	74279	75764	77249	14062	12234					
				2	2	180	56	14	...R14... 71978	73418	74857	77736	79291	80845	14062	12234				
						192	60	16	...R15... 78720	80294	81869	85017	86717	88418	15888	14062				
					2	2	204	60	16	...R16... 86088	87810	89531	92976	94836	96695	15888	14062			
							216	60	18	...R17... 89504	91294	93085	96665	98599	100530	17710	15888			
						2	2	240	60	18	...R18... 96336	98263	100190	104043	106125	108205	17710	15888		
								1	1	120	52/40	10	...V6... 48570	49541	50512	52455	53505	54553	10410	8584
										132	52/40	12	...V7... 51569	52599	53631	55694	56807	57922	12234	10410
								2	2	144	52/40	12	...V8... 58596	59769	60941	63285	64550	65816	12234	10410
										156	56/44	12	...V9... 63784	65060	66335	68886	70265	71642	12234	10410
2	2	168	56/44	14	...V10... 69360	70746			72133	74908	76406	77904	14062	12234						
		180	56/44	14	...V11... 72573	74025			75476	78379	79947	81515	14062	12234						
	2	2	192	60/44	16	...V12... 79337			80924	82510	85684	87398	89110	15888	14062					
			204	60/44	16	...V13... 86788			88523	90259	93731	95605	97480	15888	14062					
		2	2	216	60/44	18			...V14... 90215	92020	93824	97433	99381	101329	17710	15888				
				240	60/44	18			...V15... 97071	99013	100954	104838	106935	109032	17710	15888				
				1	1	90			48	10	...T6... 38360	39126	39894	—	—	—	10410	8584		
						96			48	10	...T7... 39752	40547	41342	—	—	—	10410	8584		
				2	1	108			52	10	...T8... 42536	43387	44237	—	—	—	10410	8584		
						120			54	12	...T9... 48904	49881	50860	—	—	—	12234	10410		
					2	2			132	54	12	...T10... 51903	52941	53978	—	—	—	12234	10410	
144	54	14					...T11... 58931	60109	61289	—	—	—	14062	12234						
2	2	156				60	14	...T12... 64118	65400	66682	—	—	—	14062	12234					
		168				60	14	...T13... 69694	71087	72482	—	—	—	14062	12234					
	2	2				180	60	16	...T14... 72907	74366	75824	—	—	—	15888	14062				
						192	60	16	...T15... 79671	81264	82859	—	—	—	15888	14062				
		2				2	204	60	16	...T16... 87122	88864	90607	—	—	—	15888	14062			
							216	60	18	...T17... 90550	92361	94171	—	—	—	17710	15888			
						2	2	240	60	20	...T18... 97406	99354	101302	—	—	—	19536	17710		

To include (1) Power per Seat, append P to end of product number and add list price.

To include (1) Power per Every Two Seats + Ends, append P2 to end of product number and add list price.

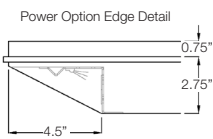
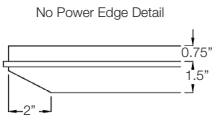

> To Order:  
For product numbers, join the Prefix, Top Code and Base/Corner Detail Code; read across and down for price.  
Ex. For 90w 48d Rectangle Marble Top, Square Corners, 8-in Bases, w/ Power, Prod No. is MTMR6S8P; list price is \$46988.

! Notes:  
Marble: Carrara  
Painted Subtop, Black  
Power option includes set number of power units. See Page CMO3 for qty per table size.  
Each table end power unit includes (1) simplex, (1) USB-A+C, (1) AAP Blank (1) AAP w/ HDMI.  
Each table side power unit includes (1) simplex, (1) USB-A+C, (2) AAP Blank.  
4-trac system, 4 wire, 2 circuit hardwire is standard.  
72" soft plug infed is available with 20amp plug. UL-Recognized.  
Chicago Code option: Each station includes one 15A 125V outlet and a 5.2A USB Type-A/Type-C Charger.  
No whips or cords provided for Chicago Code option.  
The recessed power area will be illuminated, dimmable, 2700K, 2.5w/ft.



+ Options:  
Specify WB for 12-inch diameter, non-supportive, wire chase base with access panel; add \$2313 to list price.  
For Stone Tops specify metal edge finish from following standard powder coat colors:  
(MRB) Resin Black (MRBZ) Resin Bronze (MRW) Resin White  
(MRBM) Resin Matte Black (MRDBZ) Resin Dark Bronze (MRBAS) Resin Brushed Aluminum w/Steel Tint  
For (MPA) Polished Aluminum, See Customer Service for Custom Pricing. Longer lead times may apply.  
Specify SP For Soft Plug infed; no price change.  
Specify CC for Chicago Code option; no price change.

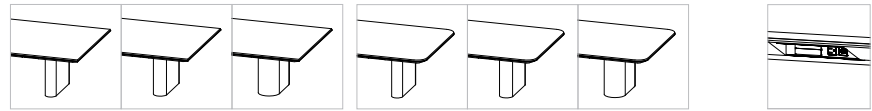

Quartz Top, 29.9h ±

Base / Corner Detail Code

Power Options

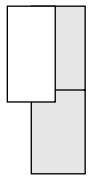
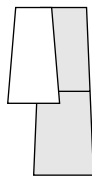
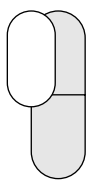
Shape	sections	pcs	w	d	Seats	Prefix & Top Code	Square Corner Detail			Radius Corner Detail, 6-in Radius			1 per Seat	1 per 2 Seats + Ends		
							6.5-in Bases	8-in Bases	12.5-in Bases	6.5-in Bases	8-in Bases	12.5-in Bases				
	1	1	90	48	8	MTQ... ...R6...	...S6 36958	...S8 37697	...S12 38436	...R6 39915	...R8 40712	...R12 41512	P 8584	P2 6759		
			96	48	8	...R7... 38299	39065	39831	41363	42190	43017	8584	6759			
	2	2	108	48	10	...R8... 40980	41799	42620	44259	45143	46030	10410	8584			
			120	52	10	...R9... 47137	48078	49021	50907	51926	52943	10410	8584			
			132	52	12	...R10... 50025	51025	52025	54027	55106	56188	12234	10410			
			144	52	12	...R11... 56873	58011	59148	61424	62651	63880	12234	10410			
			156	56	12	...R12... 61910	63148	64386	66862	68200	69537	12234	10410			
			168	56	14	...R13... 67266	68611	69956	72647	74101	75552	14062	12234			
			180	56	14	...R14... 70362	71769	73177	75991	77510	79030	14062	12234			
			192	60	16	...R15... 76872	78410	79947	83021	84684	86343	15888	14062			
			204	60	16	...R16... 84125	85808	87490	90854	92672	94488	15888	14062			
			216	60	18	...R17... 91394	93222	95050	98705	100679	102654	17710	15888			
			240	60	18	...R18... 94026	95908	97788	101549	103580	105611	17710	15888			
				1	1	120	52/40	10	...V6... 47567	48518	49471	51373	52400	53428	10410	8584
						132	52/40	12	...V7... 50467	51477	52485	54504	55594	56684	12234	10410
				2	2	144	52/40	12	...V8... 57396	58544	59691	61988	63227	64467	12234	10410
						156	56/44	12	...V9... 62482	63731	64981	67480	68830	70180	12234	10410
						168	56/44	14	...V10... 67849	69207	70563	73276	74743	76208	14062	12234
180	56/44	14				...V11... 70957	72375	73795	76633	78166	79698	14062	12234			
192	60/44	16				...V12... 77489	79040	80589	83688	85362	87036	15888	14062			
204	60/44	16				...V13... 84824	86521	88218	91610	93443	95275	15888	14062			
216	60/44	18				...V14... 92105	93948	95789	99473	101464	103453	17710	15888			
240	60/44	18				...V15... 94763	96658	98553	102342	104390	106436	17710	15888			
	1	1				90	48	10	...T6... 37667	38420	39174	—	—	—	10410	8584
						96	48	10	...T7... 39013	39794	40573	—	—	—	10410	8584
	2	2				108	52	10	...T8... 41704	42539	43372	—	—	—	10410	8584
						120	54	12	...T9... 47901	48860	49817	—	—	—	12234	10410
			132	54	12	...T10... 50801	51818	52833	—	—	—	12234	10410			
			144	54	14	...T11... 57730	58885	60040	—	—	—	14062	12234			
			156	60	14	...T12... 62816	64073	65329	—	—	—	14062	12234			
			168	60	14	...T13... 68183	69547	70911	—	—	—	14062	12234			
			180	60	16	...T14... 71291	72717	74144	—	—	—	15888	14062			
			192	60	16	...T15... 77823	79380	80937	—	—	—	15888	14062			
204	60	16	...T16... 85158	86861	88565	—	—	—	15888	14062						
216	60	18	...T17... 92439	94288	96137	—	—	—	17710	15888						
240	60	20	...T18... 95096	96998	98900	—	—	—	19536	17710						

To include (1) Power per Seat, append P to end of product number and add list price.    
 To include (1) Power per Every Two Seats + Ends, append P2 to end of product number and add list price. 

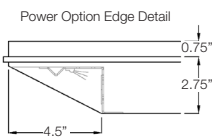
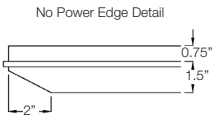

> To Order:  
 For product numbers, join the Prefix, Top Code and Base/Corner Detail Code; read across and down for price.  
 Ex. For 90w 48d Rectangle Quartz Top, Square Corners, 8-in Bases, w/ Power, Prod No. is MTQR6S8P; list price is \$46281.

! Notes:  
 Quartz: Cambria® Signature and Classic (all colors); quote required for all other offerings.  
 Painted Subtop, Black  
 Power option includes set number of power units. See Page CMO3 for qty per table size.  
 Each table end power unit includes (1) simplex, (1) USB-A+C, (1) AAP Blank (1) AAP w/ HDMI.  
 Each table side power unit includes (1) simplex, (1) USB-A+C, (2) AAP Blank.  
 4-trac system, 4 wire, 2 circuit hardwire is standard.  
 72" soft plug infed is available with 20amp plug. UL-Recognized.  
 Chicago Code option: Each station includes one 15A 125V outlet and a 5.2A USB Type-A/Type-C Charger.  
 No whips or cords provided for Chicago Code option.  
 The recessed power area will be illuminated, dimmable, 2700K, 2.5w/ft .



+ Options:  
 Specify WB for 12-inch diameter, non-supportive, wire chase base with access panel; add \$2313 to list price.  
 For Stone Tops specify metal edge finish from following standard powder coat colors:  
 (MRB) Resin Black (MRBZ) Resin Bronze (MRW) Resin White  
 (MRBM) Resin Matte Black (MRDBZ) Resin Dark Bronze (MRBAS) Resin Brushed Aluminum w/Steel Tint  
 For (MPA) Polished Aluminum, See Customer Service for Custom Pricing. Longer lead times may apply.  
 Specify SP For Soft Plug infed; no price change.  
 Specify CC for Chicago Code option; no price change.

