

TUOHY

Axis



Casegoods: **Axis**

- | | |
|-------------------------------|------|
| Mobile Tables | AA3 |
| Mobile Pedestals | AA4 |
| Panel System | AA6 |
| Power Infeeds | AA7 |
| End Mount Pole | AA7 |
| Data Connectors | AA7 |
| Divider Screens | AA8 |
| Clear Glass | AA8 |
| Low-Iron Glass | AA9 |
| Grey Glass | AA10 |
| Acid Etched on Clear Glass | AA11 |
| Acid-Etched on Low-Iron Glass | AA12 |
| Acoustic Panels | AA13 |

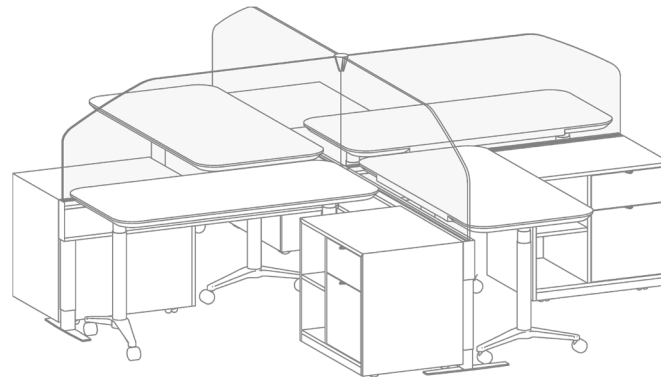
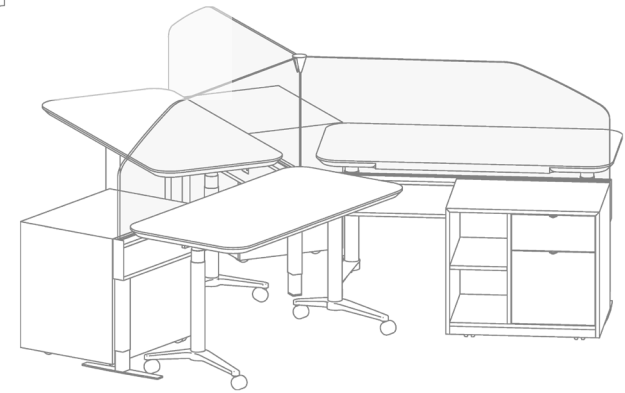
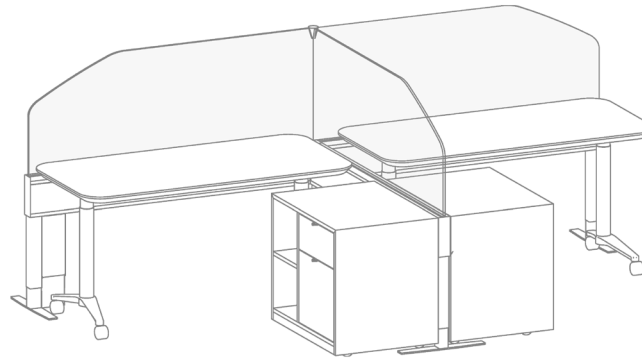

Mobile Tables
Height Adjustable

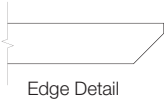
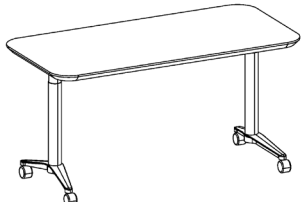

Description	Prod. No. Prefix	Top Material (specify by code)			Wire Management Basket (Optional)
		HPL	Wood 1	Wood 2	
Adj Ht Mobile Table, 26.5-52.5h		...HPL	...W1	...W2	WMB
• 60 x 30 Table	AXA6030...	5829	6136	6566	445
72 x 30 Table	AXA7230...	5984	6300	6741	445

To Include Wire Management Basket Append **WMB** to End of Product Number. Add Cost to List Price.

> To Order:

For product number, append Top Material Code to Prod. No. Prefix.
For list price, read across from Prefix Code and down from Top Material Code; price includes leg and foot finish option.
Ex. For 60x30 Table with Wood1 Top, product number is AXA6030W1; list price is \$6136.

! Notes:

HPL: Formica 949-58 White with PVC Edge.

Wood1: All TUOHY Wood1 offerings.

Wood2: All TUOHY Wood2 offerings.

Tops have Bevel Edge Detail.

Worksurfaces are undersized 1-in on all sides to allow for pinch point clearances.

All tables include Linak USB Charger with One USB Type A 7.5W, Two USB Type-C 50W. White Finish.

Linak USB Charger to be field mounted to top or bottom of worksurface. Plugs directly to control box.

Optional Wire Management Basket is finished MRB Resin Black; includes 6-outlet surge protector.

+ Options

Specify metal leg and foot finish: MRB Resin Black, MRW Resin White, MRSA Resin Satin Aluminum.

To Add Optional Baltic Birch Top Edgeband specify Option BB (no price change). Only available on Wood Tops.

The BB Edge will receive the same stain as the veneer top which may result in a dramatic color contrast.

Desks are electric powered. See below for battery power for desk.

Optional Wire Management Basket

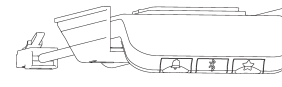
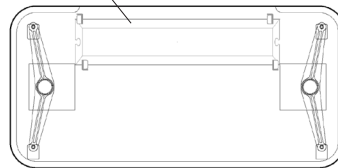

Adjustable Height Table Controller



Baltic Birch Edgeband

Battery Power Options

Battery Kit	ELBK	1075
Charging Kit	ELCK	221

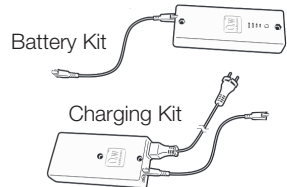

! Notes:

Battery Kit includes Battery and 8-in cable to plug into desk control box.

Charging Kit includes 8-in cable, charger, and power cable.

Wire Management Basket is recommended.

Specify: Product Number & Qty
Tagging
Wood Finish

- Denotes Item is illustrated.
- Includes locks.

Prices listed in Wood1 Finishes.

Mobile Pedestals, 26.75h
Mitered Construction

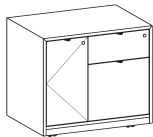
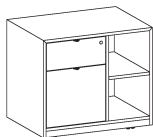
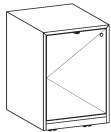

Pull Detail

Description	18d		21d	
	Prod. No.	List \$	Prod. No.	List \$
• Cabinet 18w LH	AXBCL18	3042	AXCCL18	3199
Cabinet 18w RH	AXBCR18	3042	AXCCR18	3199
Cabinet 20w LH	AXBCL20	3096	AXCCL20	3563
Cabinet 20w RH	AXBCR20	3096	AXCCR20	3563
Cabinet 30w DBL	AXBC30	3348	AXCC30	3851
Cabinet 36w DBL	AXBC36	3563	AXCC36	4096
• Box/File 18w	AXBR18	3448	AXCR18	3648
Box/File 20w	AXBR20	3490	AXCR20	4014
• Box/File18 - Open12 30w	AXBRA30	3862	AXCRA30	4440
Box/File18 - Open18 36w	AXBRA36	4117	AXCRA36	4734
Open12 - Box/File18 30w	AXBAR30	3862	AXCAR30	4440
Open18 - Box/File18 36w	AXBAR36	4117	AXCAR36	4734
Box/File18 - RH Cabinet12 30w	AXBRC30	4033	AXCRC30	4638
Box/File18 - RH Cabinet18 36w	AXBRC36	4217	AXCRC36	4850
• LH Cabinet12 - Box/File18 30w	AXBCR30	4033	AXCCR30	4638
LH Cabinet18 - Box/File18 36w	AXBCR36	4217	AXCCR36	4850

! Notes:

Mobile Pedestals are finished all sides
Mitered Construction

+ Options

Specify Pull Finish: MRB Resin Black, MRW Resin White, MRSA Resin Satin Aluminum
Locks are included standard. For No Locks Specify NL.

To add optional Baltic Birch Top Edgeband specify Option BB, No Price Change.

The BB Edge will receive the same stain as the veneer case which may result in a dramatic color contrast.

Mobile Pedestals, 26.75h
Butt-Joint Construction

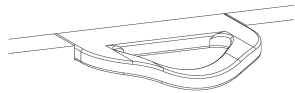
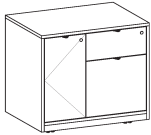
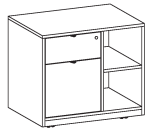
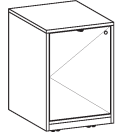

Pull Detail

Description	18d		21d	
	Prod. No.	List \$	Prod. No.	List \$
• Cabinet 18w LH	AXDCL18	2189	AXECL18	2303
Cabinet 18w RH	AXDCR18	2189	AXECR18	2303
Cabinet 20w LH	AXDCL20	2230	AXECL20	2564
Cabinet 20w RH	AXDCR20	2230	AXECR20	2564
Cabinet 30w DBL	AXDC30	2411	AXEC30	2773
Cabinet 36w DBL	AXDC36	2564	AXEC36	2949
• Box/File 18w	AXDR18	2483	AXER18	2627
Box/File 20w	AXDR20	2514	AXER20	2891
• Box/File18 - Open12 30w	AXDRA30	2780	AXERA30	3197
Box/File18 - Open18 36w	AXDRA36	2964	AXERA36	3409
Open12 - Box/File18 30w	AXDAR30	2780	AXEAR30	3197
Open18 - Box/File18 36w	AXDAR36	2964	AXEAR36	3409
Box/File18 - RH Cabinet12 30w	AXDRC30	2904	AXERC30	3339
Box/File18 - RH Cabinet18 36w	AXDRC36	3037	AXERC36	3491
• LH Cabinet12 - Box/File18 30w	AXDCR30	2823	AXECR30	3339
LH Cabinet18 - Box/File18 36w	AXDCR36	2952	AXECR36	3491

! Notes:

Mobile Pedestals are finished all sides
Butt-Joint Construction

+ Options

Specify Pull Finish: MRB Resin Black, MRW Resin White, MRSA Resin Satin Aluminum

Locks are included standard. For No Locks Specify NL.

To add optional Baltic Birch Top Edgeband specify Option BB, No Price Change.

The BB Edge will receive the same stain as the veneer case which may result in a dramatic color contrast.

Panel System, 26.8h

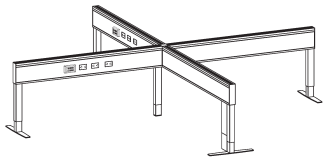
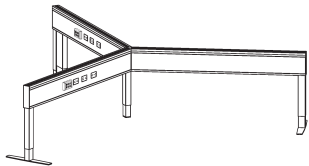
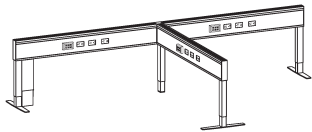

Description	Product No.	List \$	+ Cover Panel (Optional)	
			Wood1	Wood2
T-Station (2 Person)			W1	W2
60 x 60 x 60	AXFA	9374	2363	2481
• 60 x 60 x 72	AXFB	9647	2829	2972
72 x 72 x 60	AXFC	9833	2829	2972
72 x 72 x 72	AXFD	10056	2567	2696
Y-Station (3 Person)			W1	W2
• 60 x 60 x 60	AXGA	9070	2363	2481
72 x 72 x 72	AXGB	9750	2567	2696
X-Station (4 Person)			W1	W2
• 60 x 60 x 60 x 60	AXHA	11715	2741	2879
60 x 72 x 60 x 72	AXHB	12217	3645	3827
72 x 72 x 72 x 72	AXHC	12642	3383	3553



For Optional Cover Panel, append the Cover Panel Code to the Prod. No. add Cost to List Price.

! Notes:

- Each Powered Beam includes 15 Amp Outlets, (2) Circuit 1 Outlets, and (1) Circuit 4 Outlets.
- Each Powered Beam includes Single Gang Plate Adapter and 6 Port Data Gang Plate.
- Data Connectors and/or Hole Blanks need to be ordered separately.
- Each Station includes Infeed Box.
- Specify Divider Screens from listing on page AAX8-AAX13

+ Options:

- Specify Panel System Finish: Black (~MRB). Power Receptacles are Black.
- Satin White (~MRW). Power Receptacles are White
- Metallic Silver (~MRSA). Power Receptacles are Black.
- For Chicago Code append CC to end of Product Number; No price change. See Following Notes Specific to Chicago Code:
 - Junction box allows for two Single Gang Outlets per side.
 - Junction boxes do not include electrical connectors.
 - Boxes are UL Listed.
 - Boxes have standard 0.875-in knockouts for electrical connectors.
 - Junction boxes can be used with either 15 Amp or 20 Amp Single Gang Outlets.
 - Standard NEMA outlets.
 - Decorative outlets cannot be used.

Specify: Product Number & Qty
 Tagging
 Wood Finish

- Denotes Item is illustrated.
- Includes locks.

Prices listed in Wood1 Finishes.

Power Infeeds

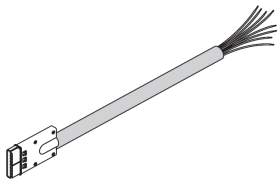

Description	Product No.	List \$
Power Infeeds - 8 Wire 4 Circuit Hardwire		
72-in Infeed	AXJ-72	545
72-in New York Infeed	AXJ-NY	1084
144-in Ceiling Infeed*	AXJ-144	638

! Notes:
 Side-mount Base In-feeds provide interface with building power at the end of the power units and mounts to the powerway at the jumper location.
 Each Base In-feed is 6-in length, encased in "Liquid Tight".
 New York City Code requires the use of a special Base Feed with an In-line Junction Box.
 The Power Infeeds are Not available in a Soft Plug option.
 *Ceiling Infeed Option requires a separately specified End Mount Pole.

End Mount Pole



End Mount Pole	AXKA	1793
----------------	------	------

! Notes:
 End Mount Poles are used for concealing In-Feeds or Data Cables from a Max 11-Ft 6-in standard suspended ceiling.
 Order Ceiling Infeed Separately.
 Poles Must be attached to ceiling grid at time of installation. Beam will not support End Mount Pole alone.
 Poles are Not UL listed for splicing cables in pole and are for Aesthetic Purposes Only.
 Specify End Mount Pole finish: Black (~MRB), Satin White (~MRW), Metallic Silver (~MRSA)

Data Connectors

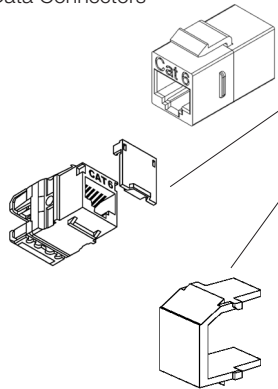

Data		
Cat 6 Inline Coupler, Black	AXLA	23
Cat 6 MT-Series Keystone, Black	AXLB	23
Blank Keystone Module (10-Pack), Black	AXLC	17

! Notes:
 Each Data Plate in the Panel System Includes 6 Ports.



Divider Screens

Clear Glass

Divider Screen only.
See pg AX6 for Cooresponding
Panel System.

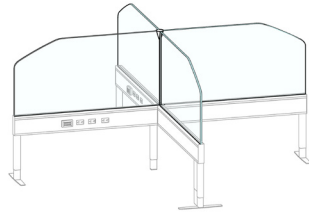
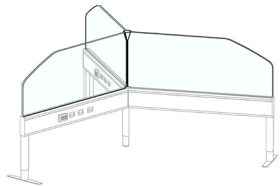

Description	Product No.	List \$	Product No.	List \$	Product No.	List \$
Glass Divider for T-Station (2 Person)	16"h (42" Installed)		28"h (54" Installed)		34"h (60" Installed)	
60 x 60 x 60	• AXFAU16	1715	AXFAU28	3604	AXFAU34	4124
60 x 60 x 72	AXFBU16	1798	AXFBU28	3783	AXFBU34	4333
72 x 72 x 60	AXFCU16	1880	AXFCU28	3962	AXFCU34	4541
72 x 72 x 72	AXFDU16	1964	AXFDU28	4140	AXFDU34	4749
Glass Divider for Y-Station (3 Person)	16"h (42" Installed)		28"h (54" Installed)		34"h (60" Installed)	
60 x 60 x 60	AXGAU16	1715	• AXGAU28	3604	AXGAU34	4124
72 x 72 x 72	AXGDU16	1964	AXGDU28	4140	AXGDU34	4749
Glass Divider for X-Station (4 Person)	16"h (42" Installed)		28"h (54" Installed)		34"h (60" Installed)	
60 x 60 x 60 x 60	AXHAU16	2197	AXHAU28	4708	• AXHAU34	5401
60 x 72 x 60 x 72	AXHBU16	2363	AXHBU28	5064	AXHBU34	5818
72 x 72 x 72 x 72	AXHDU16	2528	AXHDU28	5421	AXHDU34	6235

! Notes:

Divider Screen Product Numbers include a complete set of divider screens for the panel system layout.
Ex. AXFAU16 Includes three 16h Clear Glass Divider Screens to be used with the item number AXFA panel sytem listed on page AAX6.

Divider Screens

Low-Iron Glass

Divider Screen only.
See pg AX6 for Cooresponding
Panel System.

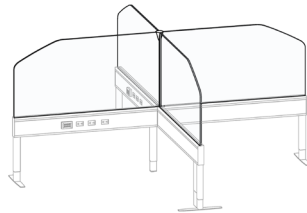
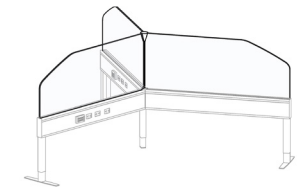

Description	Product No.	List \$	Product No.	List \$	Product No.	List \$
Glass Divider for T-Station (2 Person)	16"h (42" Installed)		28"h (54" Installed)		34"h (60" Installed)	
60 x 60 x 60	• AXFAV16	1892	AXFAV28	3946	AXFAV34	4540
60 x 60 x 72	AXFBV16	1987	AXFBV28	4146	AXFBV34	4775
72 x 72 x 60	AXFCV16	2080	AXFCV28	4347	AXFCV34	5011
72 x 72 x 72	AXFDV16	2176	AXFDV28	4548	AXFDV34	5246
Glass Divider for Y-Station (3 Person)	16"h (42" Installed)		28"h (54" Installed)		34"h (60" Installed)	
60 x 60 x 60	AXGAV16	1892	• AXGAV28	3946	AXGAV34	4540
72 x 72 x 72	AXGDV16	2176	AXGDV28	4548	AXGDV34	5246
Glass Divider for X-Station (4 Person)	16"h (42" Installed)		28"h (54" Installed)		34"h (60" Installed)	
60 x 60 x 60 x 60	AXHAV16	2433	AXHAV28	5164	• AXHAV34	5956
60 x 72 x 60 x 72	AXHBV16	2623	AXHBV28	5564	AXHBV34	6425
72 x 72 x 72 x 72	AXHDV16	2812	AXHDV28	5966	AXHDV34	6896

! Notes:

Divider Screen Product Numbers include a complete set of divider screens for the panel system layout.
Ex. AXFAV16 Includes three 16h Low-Iron Glass Divider Screens to be used with the item number AXFA panel sytem listed on page AAX6.

Specify: Product Number & Qty
Tagging
Wood Finish

- Denotes Item is illustrated.
- Includes locks.

Prices listed in Wood1 Finishes.

Divider Screens

Grey Glass

Divider Screen only.
See pg AX6 for Cooresponding
Panel System.

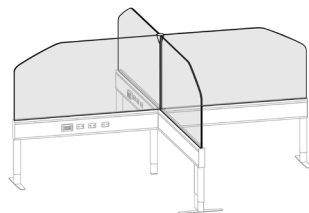
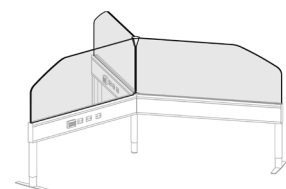
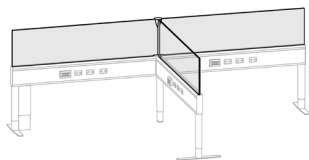

Description	Product No.	List \$	Product No.	List \$	Product No.	List \$
Glass Divider for T-Station (2 Person)						
			16"h (42" Installed)		28"h (54" Installed)	34"h (60" Installed)
60 x 60 x 60	• AXFAW16	2522	AXFAW28	5171	AXFAW34	5960
60 x 60 x 72	AXFBW16	2643	AXFBW28	5437	AXFBW34	6272
72 x 72 x 60	AXFCW16	2762	AXFCW28	5702	AXFCW34	6584
72 x 72 x 72	AXFDW16	2882	AXFDW28	5967	AXFDW34	6895
Glass Divider for Y-Station (3 Person)						
			16"h (42" Installed)		28"h (54" Installed)	34"h (60" Installed)
60 x 60 x 60	AXGAW16	2522	• AXGAW28	5171	AXGAW34	5960
72 x 72 x 72	AXGDW16	2882	AXGDW28	5967	AXGDW34	6895
Glass Divider for X-Station (4 Person)						
			16"h (42" Installed)		28"h (54" Installed)	34"h (60" Installed)
60 x 60 x 60 x 60	AXHAW16	3275	AXHAW28	6796	• AXHAW34	7849
60 x 72 x 60 x 72	AXHBW16	3513	AXHBW28	7327	AXHBW34	8471
72 x 72 x 72 x 72	AXHDW16	3753	AXHDW28	7858	AXHDW34	9096

! Notes:

Divider Screen Product Numbers include a complete set of divider screens for the panel system layout.
Ex. AXFAW16 Includes three 16h Grey Glass Divider Screens to be used with the item number AXFA panel sytem listed on page AAX6.

Divider Screens

Acid Etched on Clear Glass

Divider Screen only.

See pg AX6 for Cooresponding Panel System.

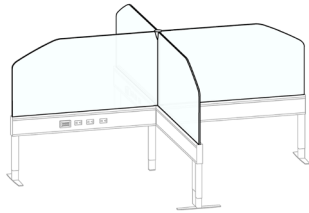
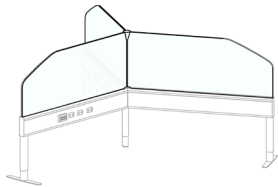
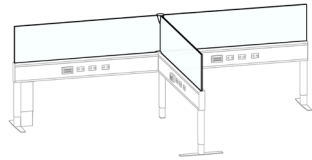

Description	Product No.	List \$	Product No.	List \$	Product No.	List \$
Glass Divider for T-Station (2 Person)	16"h (42" Installed)		28"h (54" Installed)		34"h (60" Installed)	
60 x 60 x 60	• AXFAX16	2191	AXFAX28	4524	AXFAX34	5243
60 x 60 x 72	AXFBX16	2307	AXFBX28	4763	AXFBX34	5522
72 x 72 x 60	AXFCX16	2420	AXFCX28	5000	AXFCX34	5802
72 x 72 x 72	AXFDX16	2534	AXFDX28	5238	AXFDX34	6084
Glass Divider for Y-Station (3 Person)	16"h (42" Installed)		28"h (54" Installed)		34"h (60" Installed)	
60 x 60 x 60	AXGAX16	2191	• AXGAX28	4524	AXGAX34	5243
72 x 72 x 72	AXGDX16	2534	AXGDX28	5238	AXGDX34	6084
Glass Divider for X-Station (4 Person)	16"h (42" Installed)		28"h (54" Installed)		34"h (60" Installed)	
60 x 60 x 60 x 60	AXHAX16	2834	AXHAX28	5935	• AXHAX34	6892
60 x 72 x 60 x 72	AXHBX16	3062	AXHBX28	6410	AXHBX34	7453
72 x 72 x 72 x 72	AXHDX16	3289	AXHDX28	6886	AXHDX34	8013

! Notes:

Divider Screen Product Numbers include a complete set of divider screens for the panel system layout.

Ex. AXFAX16 Includes three 16h Acid Etched on Clear Glass Divider Screens to be used with the item number AXFA panel sytem listed on page AAX6.

Divider Screens

Acid Etched on Low-Iron Glass

Divider Screen only.

See pg AX6 for Cooresponding Panel System.

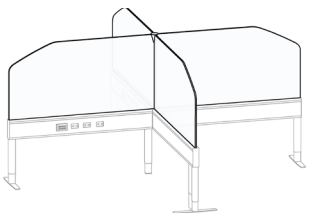
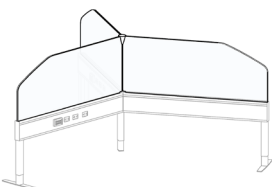

Description	Product No.	List \$	Product No.	List \$	Product No.	List \$
Glass Divider for T-Station (2 Person)	16"h (42" Installed)		28"h (54" Installed)		34"h (60" Installed)	
60 x 60 x 60	• AXFAY16	2514	AXFAY28	5143	AXFAY34	5993
60 x 60 x 72	AXFBY16	2648	AXFBY28	5421	AXFBY34	6322
72 x 72 x 60	AXFCY16	2783	AXFCY28	5697	AXFCY34	6651
72 x 72 x 72	AXFDY16	2917	AXFDY28	5976	AXFDY34	6979
Glass Divider for Y-Station (3 Person)	16"h (42" Installed)		28"h (54" Installed)		34"h (60" Installed)	
60 x 60 x 60	AXGAY16	2514	• AXGAY28	5143	AXGAY34	5993
72 x 72 x 72	AXGDY16	2917	AXGDY28	5976	AXGDY34	6979
Glass Divider for X-Station (4 Person)	16"h (42" Installed)		28"h (54" Installed)		34"h (60" Installed)	
60 x 60 x 60 x 60	AXHAY16	3262	AXHAY28	6760	• AXHAY34	7893
60 x 72 x 60 x 72	AXHBY16	3531	AXHBY28	7314	AXHBY34	8550
72 x 72 x 72 x 72	AXHDY16	3800	AXHDY28	7870	AXHDY34	9207

! Notes:

Divider Screen Product Numbers include a complete set of divider screens for the panel system layout.

Ex. AXFAY16 Includes three 16h Acid Etched on Low-Iron Glass Divider Screens to be used with the item number AXFA panel sytem listed on page AAX6.

Divider Screens

Acoustic

Divider Screen only.
See pg AX6 for Cooresponding
Panel System.

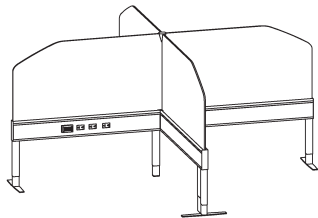
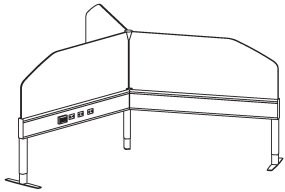
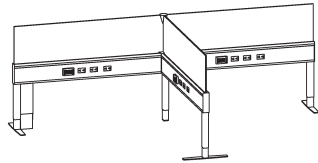

Description	Product No.	List \$	Product No.	List \$	Product No.	List \$
Acoustic Divider for T-Station (2 Person)	16"h (42" Installed)		28"h (54" Installed)		34"h (60" Installed)	
60 x 60 x 60	• AXFAZ16	1930	AXFAZ28	1930	AXFAZ34	3335
60 x 60 x 72	AXFBZ16	1933	AXFBZ28	2415	AXFBZ34	3336
72 x 72 x 60	AXFCZ16	1930	AXFCZ28	2901	AXFCZ34	3337
72 x 72 x 72	AXFDZ16	1939	AXFDZ28	3386	AXFDZ34	3339
Acoustic Divider for Y-Station (3 Person)	16"h (42" Installed)		28"h (54" Installed)		34"h (60" Installed)	
60 x 60 x 60	AXGAZ16	1930	• AXGAZ28	1930	AXGAZ34	3335
72 x 72 x 72	AXGDZ16	1939	AXGDZ28	3386	AXGDZ34	3339
Acoustic Divider for X-Station (4 Person)	16"h (42" Installed)		28"h (54" Installed)		34"h (60" Installed)	
60 x 60 x 60 x 60	AXHAZ16	2474	AXHAZ28	1932	• AXHAZ34	3338
60 x 72 x 60 x 72	AXHBZ16	2481	AXHBZ28	3445	AXHBZ34	4351
72 x 72 x 72 x 72	AXHDZ16	2487	AXHDZ28	4416	AXHDZ34	4353

! Notes:

Divider Screen Product Numbers include a complete set of divider screens for the panel system layout.
Ex. AXFAZ16 Includes three 16h Acoustic Divider Screens to be used with the item number AXFA panel sytem listed on page AAX6.
Acoustic Panels are Not Self-Healing. They Should Not be Used as Tackable Panels.

+ Options:

Specify Acoustic Color: Carbon, Graphite, Snow, Taupe, Whisper. Other Colors Available Upon Request.

Acoustic Standard Color Options:



Other colors available upon request:



Product Variances | Variation in fiber and color and patterning may occur.

Due to the nature of non-woven materials, light may pass through in any thickness or color. A translucent appearance is most apparent in lighter colors and thin material when a light source is present behind the material. Tuohy makes no claims or warranties about the material performing as opaque in any circumstance. To verify a products performance for light transmittance, a mockup of the specific intended use is recommended.

