

TUOHY

# Geneva Casegoods



Casegoods: **Geneva**

|                        |      |
|------------------------|------|
| Drawer Layouts         | AG3  |
| Half-Panel Desks       | AG4  |
| Half-Panel Runoffs     | AG4  |
| Half-Panel Bridges     | AG4  |
| Half-Panel Credenzas   | AG5  |
| Desk-Tables & Tables   | AG6  |
| Desks                  | AG7  |
| Runoffs                | AG9  |
| Bridges                | AG10 |
| Credenza Tops          | AG11 |
| Credenza Support Keels | AG12 |
| L/T Panels             | AG12 |
| Modesty Panels         | AG13 |
| Pedestals 28h          | AG14 |
| Pedestals 40h/54h      | AG16 |
| Pedestals, Mobile      | AG17 |
| Hutches                | AG18 |
| Wall Hutches           | AG20 |
| Towers                 | AG22 |
| Gallery Modules        | AG25 |
| Gallery Added Elements | AG27 |
| Adjustable Height      | AG28 |

Design:  
**Halsey, McCormack & Helmer**



**Drawer Layouts: Plan View**

Slides: Side-Mount

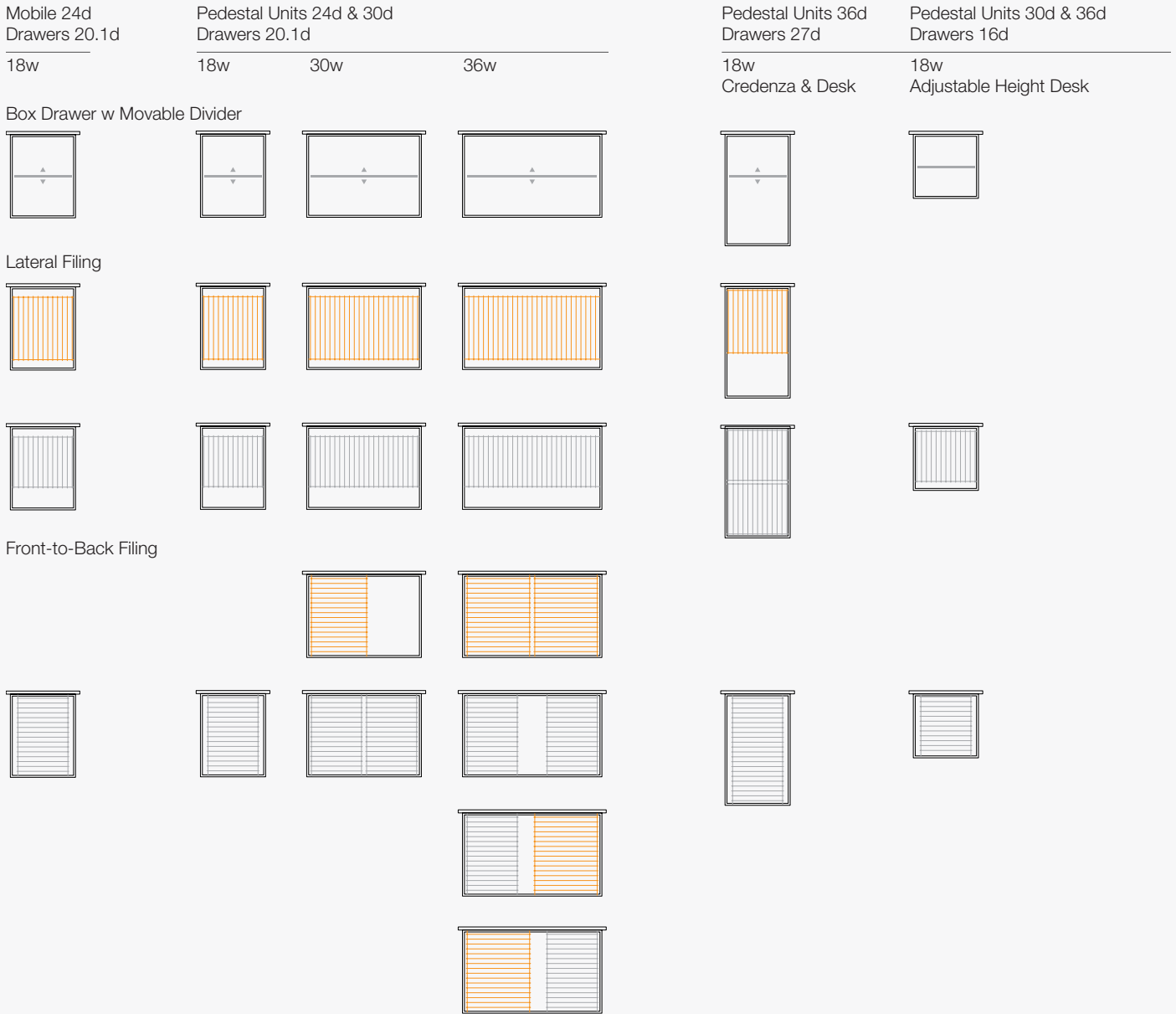

**DRAWER CONSTRUCTION**

A fine point for a quality casegood product is the inner drawer construction. Each TUOHY casegood offers you uncompromised excellence in this area as well. Drawer boxes are constructed with dovetail joinery for maximum durability. The drawer face is mounted separately to this box (i.e., five-sided construction) to maintain integrity.

Drawer bottoms are dadoed on all four sides. Slides for box drawers are rated at 100 pounds per drawer; slides for file drawers are rated at a heavy duty 150 pound load per drawer. All slides have progressive action.

Box drawers have a removable divider, adjustable when depicted (±). File drawers have suspension rods for filing laterally or front-to-back, as depicted. For Drawers for Lap Area, Drawer Pencil Tray, and Locks: See the Introduction/Terms-Options section of the Master Price List, page 12.

Half-Panel Desks, Dbl Pedestal

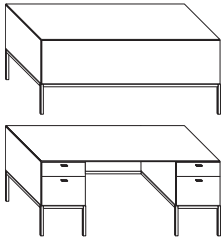

|                            |             | Product No.  | List \$ |
|----------------------------|-------------|--------------|---------|
| Rectangular Top ↯          | w 36d 29.9h | Freestanding |         |
| Desk/HalfPnl 66x36 BF-BF   | 66          | GAAP.LF      | 14799   |
| • Desk/HalfPnl 72x36 BF-BF | 72          | GAAP.MF      | 14977   |
| Desk/HalfPnl 78x36 BF-BF   | 78          | GAAP.NF      | 15120   |

! Notes:

Locks are included.

Options:

For owner-supplied and installed stone tops (templates provided), specify Option ST.

Half-Panel Desks, Sgl Pedestal

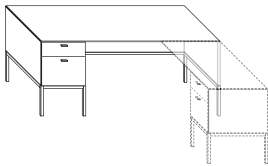

|                               |             |         |       |
|-------------------------------|-------------|---------|-------|
| Open-BF ↯                     | w 36d 29.9h |         |       |
| Desk1/HalfPnl 66x36 Open-BF   | 66          | GAAQ.LF | 11456 |
| Desk1/HalfPnl 72x36 Open-BF   | 72          | GAAQ.MF | 11633 |
| Desk1/HalfPnl 78x36 Open-BF   | 78          | GAAQ.NF | 11780 |
| BF-Open                       | 36d 29.9h   |         |       |
| Desk1/HalfPnl 66x36 BF-Open   | 66          | GAAR.LF | 11456 |
| • Desk1/HalfPnl 72x36 BF-Open | 72          | GAAR.MF | 11633 |
| Desk1/HalfPnl 78x36 BF-Open   | 78          | GAAR.NF | 11780 |

! Notes:

Locks are included.

Options:

- For Runoff or Bridge Attachment, specify Option AT, add \$236.

For owner-supplied and installed stone tops (templates provided), specify Option ST.

Half-Panel Runoffs

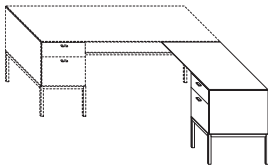

|                                 |             |        |      |
|---------------------------------|-------------|--------|------|
| LH ↯                            | w 24d 29.9h |        |      |
| Runoff/HalfPnl LH: 42 BF        | 42          | GBAQ.G | 7504 |
| Runoff/HalfPnl LH: 48 BF        | 48          | GBAQ.H | 7624 |
| Runoff/HalfPnl LH: 54 BF        | 54          | GBAQ.J | 7752 |
| Runoff/HalfPnl LH: 60 LatB-LatF | 60          | GBAS.K | 8484 |
| RH ↯                            | w 24d 29.9h |        |      |
| Runoff/HalfPnl RH: 42 BF        | 42          | GBAR.G | 7504 |
| Runoff/HalfPnl RH: 48 BF        | 48          | GBAR.H | 7624 |
| Runoff/HalfPnl RH: 54 BF        | 54          | GBAR.J | 7752 |
| Runoff/HalfPnl RH: 60 LatB-LatF | 60          | GBAT.K | 8484 |

Options:

For owner-supplied and installed stone tops (templates provided), specify Option ST.

Half-Panel Bridges

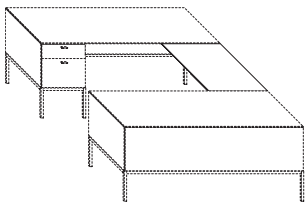

|                    |             |        |      |
|--------------------|-------------|--------|------|
| With Back Panel ‡  | w 24d 29.9h |        |      |
| Bridge/HalfPnl: 36 | 36          | GCAV.F | 3338 |
| Bridge/HalfPnl: 42 | 42          | GCAV.G | 3487 |
| Bridge/HalfPnl: 48 | 48          | GCAV.H | 3665 |
| Bridge/HalfPnl: 54 | 54          | GCAV.J | 3784 |
| Top Only           | w 24d 1.5th |        |      |
| Bridge24Top: 36    | 36          | GCAW.F | 1670 |
| Bridge24Top: 42    | 42          | GCAW.G | 1743 |
| Bridge24Top: 48    | 48          | GCAW.H | 1831 |
| Bridge24Top: 54    | 54          | GCAW.J | 1894 |

! Notes:

Width dimensions shown above are nominal.

Options:

For owner-supplied and installed stone tops (templates provided), specify Option ST.

Specify: Product Number  
Quantity  
Tagging  
Wood Finish  
Hardware Finish

• Denotes Item is illustrated.  
↯ Includes locks.  
‡ Requires field sub-assembly.

Metal finish is MBN Brushed Nickel.

Prices listed in Wood1 Finishes.

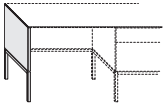
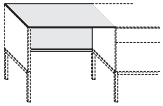
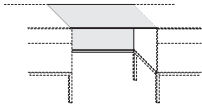
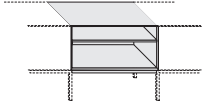
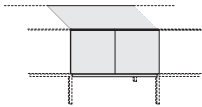
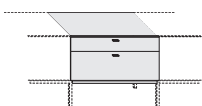
| Half-Panel Credenzas  | Includes Top ↯                | w   | Product No.     |               | List \$     |         |
|---|-------------------------------|-----|-----------------|---------------|-------------|---------|
|   |                               |     | Unfinished Back | Finished Back | Product No. | List \$ |
|   | Credenza/HalfPnl              | 24d | GG241-          | 645           | GH241-      | 645     |
|    | • End Panel                   | 1   | A               | 722           | A           | 722     |
|   | End Panel - For Runoff/Bridge | 1   | Q               | 777           | Q           | 777     |
|    | End/Back Panel 23w            | 23  | 23              | 2255          | 23          | 2339    |
|   | End/Back Panel 29w            | 29  | 29              | 2339          | 29          | 2470    |
|   | • End/Back Panel 35w          | 35  | 35              | 2426          | 35          | 2588    |
|   | End/Back Panel 41w            | 41  | 41              | 2531          | 41          | 2738    |
|   | End/Back Panel 47w            | 47  | 47              | 2666          | 47          | 2917    |
|   | End/Back Panel 53w            | 53  | 53              | 2747          | 53          | 3039    |
|    | Kneehole Panel 24w            | 24  | 24              | 2255          | 24          | 2339    |
|   | Kneehole Panel 30w            | 30  | 30              | 2339          | 30          | 2470    |
|   | • Kneehole Panel 36w          | 36  | 36              | 2426          | 36          | 2588    |
|   | Kneehole Panel 42w            | 42  | 42              | 2531          | 42          | 2738    |
|   | Kneehole Panel 48w            | 48  | 48              | 2666          | 48          | 2917    |
|   | Kneehole Panel 54w            | 54  | 54              | 2747          | 54          | 3039    |
|    | Shelving 15w                  | 15  | B               | 3074          | B           | 3141    |
|   | Shelving 18w                  | 18  | C               | 3227          | C           | 3311    |
|   | Shelving 30w                  | 30  | E               | 3782          | E           | 3929    |
|   | • Shelving 36w                | 36  | F               | 4185          | F           | 4351    |
|    | Cabinet-LH 15w                | 15  | N               | 3489          | N           | 3552    |
|   | Cabinet-LH 18w                | 18  | P               | 3645          | P           | 3731    |
|   | Cabinet-RH 15w                | 15  | R               | 3489          | R           | 3552    |
|   | Cabinet-RH 18w                | 18  | S               | 3645          | S           | 3731    |
|   | Double Cabinet 30w            | 30  | U               | 4392          | U           | 4541    |
|   | • Double Cabinet 36w          | 36  | V               | 4616          | V           | 4786    |
|  | Box/File 18w                  | 18  | M               | 4095          | M           | 4267    |
|   | 3Box 18w                      | 18  | D               | 4519          | D           | 4686    |
|   | LatBox/LatFile 30w            | 30  | T               | 4957          | T           | 5124    |
|   | • LatBox/LatFile 36w          | 36  | G               | 5483          | G           | 5760    |

! For owner-supplied and installed stone tops (templates provided), specify Option ST.

Ordering Credenza/Half-Panel Units:

Note the ProductNo and List \$ that correspond to an Unfinished or Finished Back Panel. Follow the ProductNo column down until you have located the first (left-most) end panel or pedestal desired, then append the letter/number code to the original item number and add the price to the original price. Continue adding modules in this manner until your unit is complete.

The overall unit width will be the accumulated widths of all modules chosen. The overall price will be the accumulated prices and the final item number will be the original number plus all of the letter codes for the pedestals added. Maximum width under one top is 120 inches. Components are modular and may require field assembly. Finished backs may be segmented; inquire if a continuous back is required. Verify all logistical dimensions (e.g., elevators, corridors and doorways) prior to ordering large units.

Credenza Sample Order

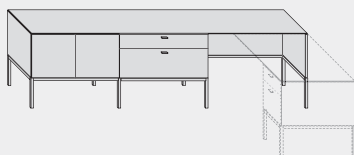

|                                 |        |      |
|---------------------------------|--------|------|
| Credenza/HalfPnl 24d, UnfinBack | GG241- | 585  |
| Double Cabinet 36               | V      | 4187 |
| LatBox/LatFile 36               | G      | 4973 |
| End/Back Panel 35               | 35     | 2200 |
| End Panel - For Runoff/Bridge   | Q      | 705  |

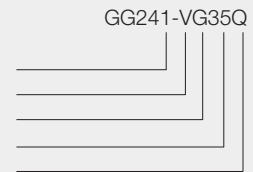

List Price: \$12650

Specify: Product Number  
Quantity  
Tagging  
Wood Finish  
Hardware Finish

• Denotes Item is illustrated.  
↯ Includes locks.  
‡ Requires field sub-assembly.

Metal finish is MBN Brushed Nickel.

Prices listed in Wood1 Finishes.

Desk-Tables & Tables

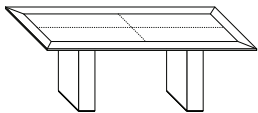
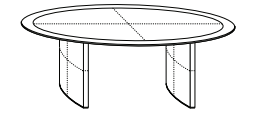
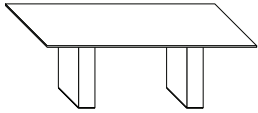
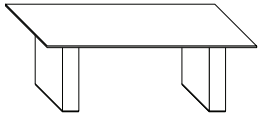

|                              |     |        |  | Product No. | List \$ | Product No.      | List \$ |
|------------------------------|-----|--------|--|-------------|---------|------------------|---------|
| Desk-Tables w Std Eased Edge |     |        |  | w           | d       | 29.9h            |         |
|                              |     |        |  | Panel Base  |         | Bowed Panel Base |         |
| RectangleDeskTbl-            | 72w | 36d    |  | GAR.7236.P  | 8643    | GAR.7236.B       | 9282    |
| RectangleDeskTbl-            | 78w | 39d    |  | GAR.7839.P  | 8930    | GAR.7839.B       | 9574    |
| • RectangleDeskTbl-          | 84w | 42d    |  | GAR.8442.P  | 9220    | GAR.8442.B       | 9866    |
| BoatDeskTbl-                 | 78w | 39/26d |  | GAB.7839.P  | 11626   | GAB.7839.B       | 12272   |
| BoatDeskTbl-                 | 84w | 42/28d |  | GAB.8442.P  | 11919   | GAB.8442.B       | 12563   |
| Tables w Std Eased Edge      |     |        |  | 84w         | d       | 29.9h            |         |
|                              |     |        |  | Panel Base  |         | Bowed Panel Base |         |
| • RectangleTbl-              | 84w | 42d    |  | GER.8442.P  | 9220    | GER.8442.B       | 9866    |
| BoatTbl-                     | 84w | 42/28d |  | GEB.8442.P  | 11997   | GEB.8442.B       | 12641   |
| EllipseTbl-                  | 84w | 42/28d |  | GEE.8442.P  | 13166   | GEE.8442.B       | 13806   |

! Notes:

See also the complete Geneva Conference Collection.  
 All units above have wood tops and wood bases.  
 An eased edge detail is standard; see kerf option below.

+ Options:

- Aluminum top reveal, specify Option AR, add 10%.
- For Silex base, specify Option LB, add 35%.
- For Stitched Silex base, specify Option SB, add 40%.
- For Silex top, specify Option LT, add 25%.
- For Stitched Silex top, specify Option SLT, add 30%.

Tops ready for customer-installed stone, specify Option ST.

Power management solutions are available in the Options section of the price schedule.

Kerf edge detail, specify Option KERF, add 3%.

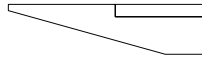

Standard

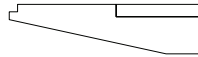

Option KERF

Desks, Double Pedestal

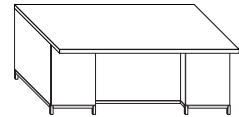
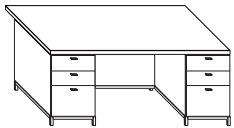
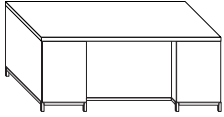
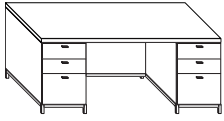

Desks, Single Pedestal

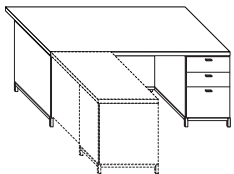
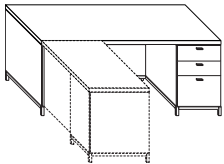

|                       |    |     |       | Product No.   | List \$ | Product No. | List \$ |
|-----------------------|----|-----|-------|---------------|---------|-------------|---------|
| Rectangular Top ↯     | w  | 36d | 29.9h | 0.5 Base Trim |         | 3.5 Base    |         |
| Desk 66x36            | 66 |     |       | GAD?.LF       | 12840   | GAA?.LF     | 15502   |
| • Desk 72x36          | 72 |     |       | GAD?.MF       | 13052   | GAA?.MF     | 15692   |
| Desk 78x36            | 78 |     |       | GAD?.NF       | 13210   | GAA?.NF     | 15841   |
| Overhang-Top ↯        | w  | 42d | 29.9h | 0.5 Base Trim |         | 3.5 Base    |         |
| Desk/Overhang 66x36   | 66 |     |       | GAF?.LF       | 12995   | GAC?.LF     | 15660   |
| • Desk/Overhang 72x36 | 72 |     |       | GAF?.MF       | 13226   | GAC?.MF     | 15861   |
| Desk/Overhang 78x36   | 78 |     |       | GAF?.NF       | 13388   | GAC?.NF     | 16017   |

? Specify configuration (user's left-right) by modifying the Product Number:

For 2BF-2BF, change the 4th digit from ? to A.

For 2F-2F, change the 4th digit from ? to B.

For 2BF-2F, change the 4th digit from ? to C.

For 2F-2BF, change the 4th digit from ? to D.

+ Options:

For Silex inset top, specify Option LT and add \$2195.

For Stitched Silex inset top, specify Option SLT and add \$2674.

For Silex drawer faces, specify Option LF and add \$1306 per drawer.

For Stitched Silex drawer faces, specify Option SF and add \$1306 per drawer.

For Silex modesty panel, specify Option LM and add \$2468.

For Stitched Silex modesty panel, specify Option SM and add \$2913.

For COM materials applied to a modesty panel, specify Option COM; see below; price per request..

! Notes:

Modesty panel is inset 5 inches.

Overhang-Tops have a 6 inch visitor's overhang.

Face locks are included as standard

|                        |    |     |       |               |       |          |       |
|------------------------|----|-----|-------|---------------|-------|----------|-------|
| Rectangular Top ↯      | w  | 36d | 29.9h | 0.5 Base Trim |       | 3.5 Base |       |
| Desk1 66x36            | 66 |     |       | GAD?.LF       | 10081 | GAA?.LF  | 11998 |
| • Desk1 72x36          | 72 |     |       | GAD?.MF       | 10296 | GAA?.MF  | 12192 |
| Desk1 78x36            | 78 |     |       | GAD?.NF       | 10451 | GAA?.NF  | 12344 |
| Overhang-Top ↯         | w  | 42d | 29.9h | 0.5 Base Trim |       | 3.5 Base |       |
| Desk1/Overhang 66x36   | 66 |     |       | GAF?.LF       | 10240 | GAC?.LF  | 12157 |
| • Desk1/Overhang 72x36 | 72 |     |       | GAF?.MF       | 10471 | GAC?.MF  | 12362 |
| Desk1/Overhang 78x36   | 78 |     |       | GAF?.NF       | 10633 | GAC?.NF  | 12517 |

? Specify configuration (user's left-right) by modifying the Product Number:

For LBase-2BF, change the 4th digit from ? to E.

For LBase-2F, change the 4th digit from ? to F.

For 2BF-LBase, change the 4th digit from ? to G.

For 2F-LBase, change the 4th digit from ? to H.

+ Options:

For Silex inset top, specify Option LT and add \$2195.

For Stitched Silex inset top, specify Option SLT and add \$2674.

For Silex drawer faces, specify Option LF and add \$1306 per drawer.

For Stitched Silex drawer faces, specify Option SF and add \$1306 per drawer.

For Silex modesty panel, specify Option LM and add \$2468.

For Stitched Silex modesty panel, specify Option SM and add \$2913.

For COM materials applied to a modesty panel, specify Option COM; see below; price per request..

! Notes:

Modesty panel is inset 5 inches.

Overhang-Tops have a 6 inch visitor's overhang.

Face locks are included as standard

Shipping address for COM/COL materials and memo samples:

TUOHY Furniture Corporation, P1 Upholstery Receiving, 42 Saint Albans Place, Chatfield, MN 55923



Specify: Product Number  
Quantity  
Tagging  
Wood Finish  
Hardware Finish

• Denotes Item is illustrated.  
‡ Requires field sub-assembly.

Metal finish is MBN Brushed Nickel.

Prices listed in Wood1 Finishes.

Desks, Bullet and P-Top

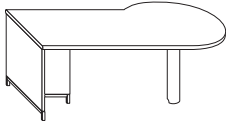
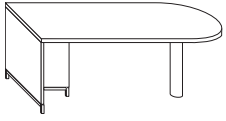

|                                 |    |     |       | Product No.   | List \$ | Product No. | List \$ |
|---------------------------------|----|-----|-------|---------------|---------|-------------|---------|
| Bullet w Post-Leg & T-Base ‡    | w  | 36d | 29.9h | 0.5 Base Trim |         | 3.5 Base    |         |
| • Desk/Bullet: Post-TBase 72x36 | 72 |     |       | GAHJ.MF       | 8770    | GAGJ.MF     | 9234    |
| Desk/Bullet: Post-TBase 78x36   | 78 |     |       | GAHJ.NF       | 9274    | GAGJ.NF     | 9738    |
| Desk/Bullet: Post-TBase 84x36   | 84 |     |       | GAHJ.OF       | 9774    | GAGJ.OF     | 10239   |
| P-Top w Post & T-Base ‡         | w  | 42d | 29.9h | 0.5 Base Trim |         | 3.5 Base    |         |
| Desk/P: Post-TBase 72x36        | 72 |     |       | GAKJ.MF       | 10537   | GAJJ.MF     | 11004   |
| Desk/P: Post-TBase 78x36        | 78 |     |       | GAKJ.NF       | 11048   | GAJJ.NF     | 11515   |
| Desk/P: Post-TBase 84x36        | 84 |     |       | GAKJ.OF       | 11559   | GAJJ.OF     | 12031   |
| • Desk/P: TBase-Post 72x36      | 72 |     |       | GAKK.MF       | 10537   | GAJK.MF     | 11004   |
| Desk/P: TBase-Post 78x36        | 78 |     |       | GAKK.NF       | 11048   | GAJK.NF     | 11515   |
| Desk/P: TBase-Post 84x36        | 84 |     |       | GAKK.OF       | 11559   | GAJK.OF     | 12031   |

+ Options:

For Silex inset top, specify Option LT and add \$2739.

For Stitched Silex inset top, specify Option SLT and add \$3219.

! Notes

Metal legs have an MBN Brushed Nickel finish; post legs are MRBS Resin Brushed Steel.

Tops have a Flush-Cut End.

Product No. List \$

Runoffs, Rectangular Top Only

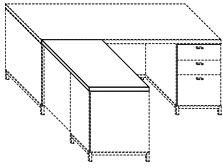

| 24d Top            | w  | 24d | 1.5th |         |      |
|--------------------|----|-----|-------|---------|------|
| Runoff24 Top: 42   | 42 |     |       | GBAL.GD | 1468 |
| Runoff24 Top: 48   | 48 |     |       | GBAL.HD | 1573 |
| • Runoff24 Top: 54 | 54 |     |       | GBAL.JD | 1671 |
| Runoff24 Top: 72   | 72 |     |       | GBAL.MD | 2109 |

+ Options:

For Silex inset top, specify Option LT and add \$1917.  
 For Stitched Silex inset top, specify Option SLT and add \$2328.

! Notes:

The recommended maximum open span under tops is 54 inches; use bases & pedestals accordingly.

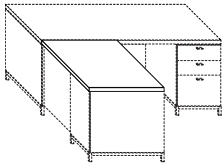

| 30d Top            | w  | 30d | 1.5th |         |      |
|--------------------|----|-----|-------|---------|------|
| Runoff30 Top: 42   | 42 |     |       | GBAL.GE | 1601 |
| Runoff30 Top: 48   | 48 |     |       | GBAL.HE | 1714 |
| • Runoff30 Top: 54 | 54 |     |       | GBAL.JE | 1825 |
| Runoff30 Top: 72   | 72 |     |       | GBAL.ME | 2202 |

+ Options:

For Silex inset top, specify Option LT and add \$2057.  
 For Stitched Silex inset top, specify Option SLT and add \$2629.

! Notes:

The maximum open span under tops is 54 inches; use bases and pedestals accordingly.

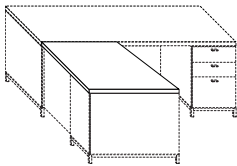

| 36d Top            | w  | 36d | 1.5th |         |      |
|--------------------|----|-----|-------|---------|------|
| Runoff36 Top: 42   | 42 |     |       | GBAL.GF | 1727 |
| Runoff36 Top: 48   | 48 |     |       | GBAL.HF | 1853 |
| • Runoff36 Top: 54 | 54 |     |       | GBAL.JF | 1976 |
| Runoff36 Top: 72   | 72 |     |       | GBAL.MF | 2284 |

+ Options:

For Silex inset top, specify Option LT and add \$2198.  
 For Stitched Silex inset top, specify Option SLT and add \$2925.

! Notes:

The maximum open span under tops is 54 inches; use bases and pedestals accordingly.

Runoffs, Bullet-Shape

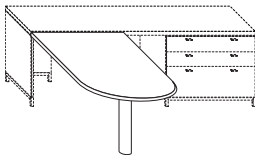

| 30d Bullet w. Post-Leg ‡     | w  | 30d | 29.9h |         |      |
|------------------------------|----|-----|-------|---------|------|
| Runoff30/Bullet: Post-Leg 48 | 48 |     |       | GBBP.HE | 6360 |
| Runoff30/Bullet: Post-Leg 54 | 54 |     |       | GBBP.JE | 6602 |
| Runoff30/Bullet: Post-Leg 60 | 60 |     |       | GBBP.KE | 6860 |
| Runoff30/Bullet: Post-Leg 66 | 66 |     |       | GBBP.LE | 7078 |
| Runoff30/Bullet: Post-Leg 72 | 72 |     |       | GBBP.ME | 7216 |

| 36d Bullet w. Post-Leg ‡       | w  | 36d | 29.9h |         |      |
|--------------------------------|----|-----|-------|---------|------|
| Runoff36/Bullet: Post-Leg 48   | 48 |     |       | GBBP.HF | 6482 |
| Runoff36/Bullet: Post-Leg 54   | 54 |     |       | GBBP.JF | 6762 |
| • Runoff36/Bullet: Post-Leg 60 | 60 |     |       | GBBP.KF | 7041 |
| Runoff36/Bullet: Post-Leg 66   | 66 |     |       | GBBP.LF | 7296 |
| Runoff36/Bullet: Post-Leg 72   | 72 |     |       | GBBP.MF | 7464 |

+ Options:

For Silex inset top, specify Option LT and add \$2739.  
 For Stitched Silex inset top, specify Option SLT and add \$3219.  
 Metal post leg has an MRBS Resin Brushed Steel finish.

Specify: Product Number  
 Quantity  
 Tagging  
 Wood Finish  
 Hardware Finish

• Denotes Item is illustrated.  
 ‡ Requires field sub-assembly.

Metal finish is MBN Brushed Nickel, except as noted.

Prices listed in Wood1 Finishes.

Bridges, Fixed Modesty Panel

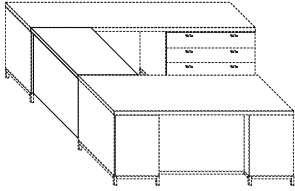

| 24d ‡          | w  | 24d | 29.9h | 0.5 Base Trim | 3.5 Base | Product No. | List \$ | Product No. | List \$ |
|----------------|----|-----|-------|---------------|----------|-------------|---------|-------------|---------|
| Bridge24: 36   | 36 |     |       |               |          | GCDM.F      | 2543    | GCAM.F      | 2718    |
| Bridge24: 42   | 42 |     |       |               |          | GCDM.G      | 2689    | GCAM.G      | 2864    |
| • Bridge24: 48 | 48 |     |       |               |          | GCDM.H      | 2868    | GCAM.H      | 3060    |
| Bridge24: 54   | 54 |     |       |               |          | GCDM.J      | 3003    | GCAM.J      | 3187    |

+ Options:

- For Silex inset top, specify Option LT and add \$1917.
- For Stitched Silex inset top, specify Option SLT and add \$2328.
- For Silex modesty panel, specify Option LM and add \$2468.
- For Stitched Silex modesty panel, specify Option SM and add \$2880.

! Notes:

- Finished modesty panel.
- Modesty panel is designed to screw to two L-Panels.

Bridges, Removable Access Panel

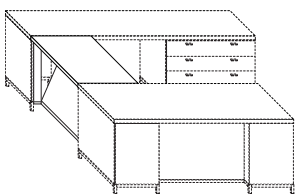

| 24d ‡                 | w  | 24d | 29.9h | 0.5 Base Trim | 3.5 Base | Product No. | List \$ | Product No. | List \$ |
|-----------------------|----|-----|-------|---------------|----------|-------------|---------|-------------|---------|
| Bridge24/Access: 36   | 36 |     |       |               |          | GCDR.F      | 2797    | GCAR.F      | 2982    |
| Bridge24/Access: 42   | 42 |     |       |               |          | GCDR.G      | 2954    | GCAR.G      | 3133    |
| • Bridge24/Access: 48 | 48 |     |       |               |          | GCDR.H      | 3132    | GCAR.H      | 3312    |
| Bridge24/Access: 54   | 54 |     |       |               |          | GCDR.J      | 3262    | GCAR.J      | 3529    |

+ Options:

- For Silex inset top, specify Option LT and add \$1917.
- For Stitched Silex inset top, specify Option SLT and add \$2328.

! Notes:

- Unfinished back on access panel.
- Access panel has 2.5 inches clearance under top.
- Access panel sits out from the wall 3 inches and is attached with Velcro® to two spacers.
- Spacers are designed to screw between two L-Panels.

Bridges, Top Only

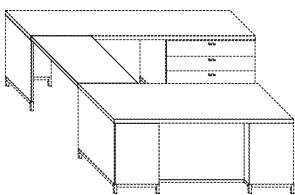

| 24d ‡             | w  | 24d | 1.5th | Product No. | List \$ |
|-------------------|----|-----|-------|-------------|---------|
| Bridge24Top: 36   | 36 |     |       | GCAL.F      | 1414    |
| Bridge24Top: 42   | 42 |     |       | GCAL.G      | 1520    |
| • Bridge24Top: 48 | 48 |     |       | GCAL.H      | 1637    |
| Bridge24Top: 54   | 54 |     |       | GCAL.J      | 1720    |

+ Options:

- For Silex inset top, specify Option LT and add \$1917.
- For Stitched Silex inset top, specify Option SLT and add \$2328.

Corner Adapter Top

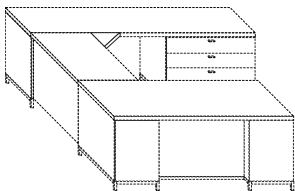

| ‡                  | 12w | 12d | 1.5th | Product No. | List \$ |
|--------------------|-----|-----|-------|-------------|---------|
| Corner Adapter Top |     |     |       | GEAL        | 533     |

! Notes:

- Available in all standard Solid Colors (only).
- Coped on two sides to mate with edge shapes of tops.

Corner Credenza

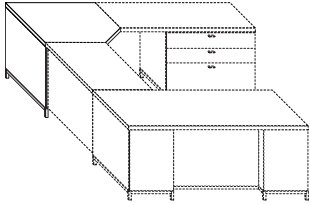

|   | Product No.   | List \$ | Product No. | List \$ |
|---|---------------|---------|-------------|---------|
| Attach Runoff/Bridges (a:b) 42w 42d 29.9h | 0.5 Base Trim |         | 3.5 Base    |         |
| CornerCredenza 24:24                      | GAMN.DD       | 3575    | GALN.DD     | 4153    |

- + Options:
- Maximum of 3 surface grommets may be used; see Options and surcharges.
- ! Notes:
- Veneer grain direction is 45 degrees.
- Corner angle dimensions are nominally 18 x 18 inches.
- Backs are finished.

Credenza Tops

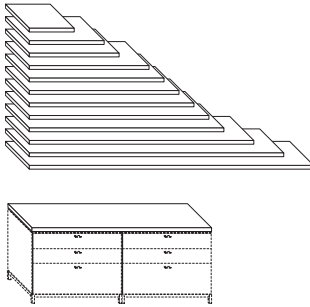

| Rectangular 24d    | w   | 24d | 1.5th |         |      |
|--------------------|-----|-----|-------|---------|------|
| CredenzaTop24: 18  | 18  |     |       | GFAL.CD | 995  |
| CredenzaTop24: 30  | 30  |     |       | GFAL.ED | 1187 |
| CredenzaTop24: 36  | 36  |     |       | GFAL.FD | 1320 |
| CredenzaTop24: 48  | 48  |     |       | GFAL.HD | 1528 |
| CredenzaTop24: 54  | 54  |     |       | GFAL.JD | 1621 |
| CredenzaTop24: 60  | 60  |     |       | GFAL.KD | 1736 |
| CredenzaTop24: 66  | 66  |     |       | GFAL.LD | 1842 |
| CredenzaTop24: 72  | 72  |     |       | GFAL.MD | 1960 |
| CredenzaTop24: 78  | 78  |     |       | GFAL.ND | 2064 |
| CredenzaTop24: 84  | 84  |     |       | GFAL.OD | 2200 |
| CredenzaTop24: 90  | 90  |     |       | GFAL.PD | 2311 |
| CredenzaTop24: 108 | 108 |     |       | GFAL.RD | 2692 |
| CredenzaTop24: 120 | 120 |     |       | GFAL.SD | 3026 |

| Rectangular 30d   | w  | 30d | 1.5th |         |      |
|-------------------|----|-----|-------|---------|------|
| CredenzaTop30: 18 | 18 |     |       | GFAL.CE | 1077 |
| CredenzaTop30: 30 | 30 |     |       | GFAL.EE | 1285 |
| CredenzaTop30: 36 | 36 |     |       | GFAL.FE | 1435 |
| CredenzaTop30: 48 | 48 |     |       | GFAL.HE | 1665 |
| CredenzaTop30: 54 | 54 |     |       | GFAL.JE | 1776 |
| CredenzaTop30: 60 | 60 |     |       | GFAL.KE | 1904 |
| CredenzaTop30: 66 | 66 |     |       | GFAL.LE | 2016 |
| CredenzaTop30: 72 | 72 |     |       | GFAL.ME | 2150 |
| CredenzaTop30: 78 | 78 |     |       | GFAL.NE | 2259 |
| CredenzaTop30: 84 | 84 |     |       | GFAL.OE | 2429 |
| CredenzaTop30: 90 | 90 |     |       | GFAL.PE | 2547 |

| Rectangular 36d   | w  | 36d | 1.5th |         |      |
|-------------------|----|-----|-------|---------|------|
| CredenzaTop36: 18 | 18 |     |       | GFAL.CF | 1185 |
| CredenzaTop36: 30 | 30 |     |       | GFAL.EF | 1411 |
| CredenzaTop36: 36 | 36 |     |       | GFAL.FF | 1545 |
| CredenzaTop36: 48 | 48 |     |       | GFAL.HF | 1805 |
| CredenzaTop36: 54 | 54 |     |       | GFAL.JF | 1923 |
| CredenzaTop36: 60 | 60 |     |       | GFAL.KF | 2069 |
| CredenzaTop36: 66 | 66 |     |       | GFAL.LF | 2185 |
| CredenzaTop36: 72 | 72 |     |       | GFAL.MF | 2345 |
| CredenzaTop36: 78 | 78 |     |       | GFAL.NF | 2470 |
| CredenzaTop36: 84 | 84 |     |       | GFAL.OF | 2649 |
| CredenzaTop36: 90 | 90 |     |       | GFAL.PF | 2776 |

- + Options:
- For Silex inset top, specify Option LT and add \$1917.
- For Stitched Silex inset top, specify Option SLT and add \$2328.
- ! Notes:
- This listing is of credenza tops only.
- The recommended maximum open span under tops is 54 inches; use bases/pedestals accordingly.

Specify: Product Number  
Quantity  
Tagging  
Wood Finish  
Hardware Finish

• Denotes Item is illustrated.  
‡ Requires field sub-assembly.

Metal finish is MBN Brushed Nickel.

Prices listed in Wood1 Finishes.

Credenza Support Keels

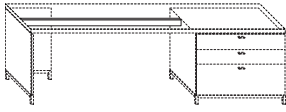

| Support Keel‡               | w  | 2d | 1h | Product No. | List \$ | Product No. | List \$ |
|-----------------------------|----|----|----|-------------|---------|-------------|---------|
| Credenza Support Keel: 52   | 52 |    |    |             |         | LG-52       | 487     |
| Credenza Support Keel: 58   | 58 |    |    |             |         | LG-58       | 503     |
| • Credenza Support Keel: 64 | 64 |    |    |             |         | LG-64       | 508     |
| Credenza Support Keel: 70   | 70 |    |    |             |         | LG-70       | 517     |
| Credenza Support Keel: 82   | 82 |    |    |             |         | LG-82       | 528     |
| Credenza Support Keel: 88   | 88 |    |    |             |         | LG-88       | 537     |

! Notes:

Required for unsupported work surface spans of 54 inches or more.  
Unit is a black rectangular 1 x 2 tube screwed to the underside of the work surface.

L/T Panels

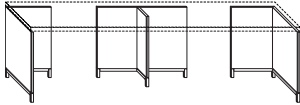

| L-Panel Unfinished Back ‡ | w  | 24d | 28.4h | 0.5 Base Trim | 3.5 Base |         |      |
|---------------------------|----|-----|-------|---------------|----------|---------|------|
| • L-Panel 18x24 LH        | 18 |     |       | GHRU.CD       | 1141     | GHNU.CD | 1608 |
| • L-Panel 18x24 RH        | 18 |     |       | GHSU.CD       | 1141     | GHPU.CD | 1608 |
| L-Panel 24x24 LH          | 24 |     |       | GHRU.DD       | 1188     | GHNU.DD | 1662 |
| L-Panel 24x24 RH          | 24 |     |       | GHSU.DD       | 1188     | GHPU.DD | 1662 |
| L-Panel 36x24 LH          | 36 |     |       | GHRU.FD       | 1285     | GHNU.FD | 1781 |
| L-Panel 36x24 RH          | 36 |     |       | GHSU.FD       | 1285     | GHPU.FD | 1781 |

| L-Panel Finished Back ‡    | w  | 24d | 28.4h | 0.5 Base Trim | 3.5 Base |         |      |
|----------------------------|----|-----|-------|---------------|----------|---------|------|
| • L-Panel FinBack 18x24 LH | 18 |     |       | GHRF.CD       | 1202     | GHNF.CD | 1638 |
| • L-Panel FinBack 18x24 RH | 18 |     |       | GHSF.CD       | 1202     | GHPF.CD | 1638 |
| L-Panel FinBack 24x24 LH   | 24 |     |       | GHRF.DD       | 1264     | GHNF.DD | 1703 |
| L-Panel FinBack 24x24 RH   | 24 |     |       | GHSF.DD       | 1264     | GHPF.DD | 1703 |
| L-Panel FinBack 36x24 LH   | 36 |     |       | GHRF.FD       | 1403     | GHNF.FD | 1843 |
| L-Panel FinBack 36x24 RH   | 36 |     |       | GHSF.FD       | 1403     | GHPF.FD | 1843 |

| T-Panel Unfinished Back ‡ | w  | 9d | 28.4h | 0.5 Base Trim | 3.5 Base |         |      |
|---------------------------|----|----|-------|---------------|----------|---------|------|
| T-Panel UnfinBack 18x9    | 18 |    |       | GHTU.C9       | 947      | GHQU.C9 | 1414 |
| • T-Panel UnfinBack 36x9  | 36 |    |       | GHTU.F9       | 1127     | GHQU.F9 | 1596 |

| T-Panel Finished Back ‡ | w  | 9d | 28.4h | 0.5 Base Trim | 3.5 Base |         |      |
|-------------------------|----|----|-------|---------------|----------|---------|------|
| T-Panel FinBack 18x9    | 18 |    |       | GHTF.C9       | 979      | GHQF.C9 | 1448 |
| • T-Panel FinBack 36x9  | 36 |    |       | GHTF.F9       | 1187     | GHQF.F9 | 1653 |

Specify: Product Number  
Quantity  
Tagging  
Wood Finish  
Hardware Finish

• Denotes Item is illustrated.

Metal finish is MBN Brushed Nickel.

Prices listed in Wood1 Finishes.

Modesty Panels, Fixed

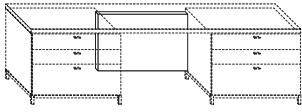

|                             |    |   |          | Product No.   | List \$ | Product No. | List \$ |
|-----------------------------|----|---|----------|---------------|---------|-------------|---------|
| Unfinished Back ‡           |    | w | 1d 28.4h | 0.5 Base Trim |         | 3.5 Base    |         |
| Modesty-Panel: 18           | 18 |   |          | GJVU.C        | 869     | GJUU.C      | 1048    |
| Modesty-Panel: 24           | 24 |   |          | GJVU.D        | 898     | GJUU.D      | 1080    |
| Modesty-Panel: 30           | 30 |   |          | GJVU.E        | 1024    | GJUU.E      | 1208    |
| • Modesty-Panel: 36         | 36 |   |          | GJVU.F        | 1127    | GJUU.F      | 1306    |
| Modesty-Panel: 42           | 42 |   |          | GJVU.G        | 1178    | GJUU.G      | 1355    |
| Modesty-Panel: 48           | 48 |   |          | GJVU.H        | 1236    | GJUU.H      | 1418    |
| Modesty-Panel: 54           | 54 |   |          | GJVU.J        | 1287    | GJUU.J      | 1467    |
| Modesty-Panel: 72           | 72 |   |          | GJVU.M        | 1439    | GJUU.M      | 1621    |
| Finished Back ‡             |    | w | 1d 28.4h | 0.5 Base Trim |         | 3.5 Base    |         |
| Modesty-Panel FinBack: 18   | 18 |   |          | GJVF.C        | 1190    | GJUF.C      | 1363    |
| Modesty-Panel FinBack: 24   | 24 |   |          | GJVF.D        | 1232    | GJUF.D      | 1406    |
| Modesty-Panel FinBack: 30   | 30 |   |          | GJVF.E        | 1373    | GJUF.E      | 1557    |
| • Modesty-Panel FinBack: 36 | 36 |   |          | GJVF.F        | 1495    | GJUF.F      | 1671    |
| Modesty-Panel FinBack: 42   | 42 |   |          | GJVF.G        | 1557    | GJUF.G      | 1728    |
| Modesty-Panel FinBack: 48   | 48 |   |          | GJVF.H        | 1635    | GJUF.H      | 1811    |
| Modesty-Panel FinBack: 54   | 54 |   |          | GJVF.J        | 1687    | GJUF.J      | 1865    |
| Modesty-Panel FinBack: 72   | 72 |   |          | GJVF.M        | 1882    | GJUF.M      | 2055    |

+ Options:

For Silex modesty panel, specify Option LM and add \$1764.

For Stitched Silex modesty panel, specify Option SM and add \$2059.

For COM materials applied to a modesty panel, specify Option COM; see below; price per request.

! Notes:

Unit is exact width with two removable cleats for mounting to L-Panels or Pedestals.

Modesty Panels, Access/Removable

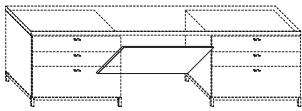

|                      |    |   |          |               |      |          |      |
|----------------------|----|---|----------|---------------|------|----------|------|
| Unfinished Back ‡    |    | w | 2d 26.9h | 0.5 Base Trim |      | 3.5 Base |      |
| Modesty-Access: 18   | 18 |   |          | GJXU.C        | 1171 | GJWU.C   | 1352 |
| Modesty-Access: 24   | 24 |   |          | GJXU.D        | 1202 | GJWU.D   | 1387 |
| Modesty-Access: 30   | 30 |   |          | GJXU.E        | 1296 | GJWU.E   | 1475 |
| • Modesty-Access: 36 | 36 |   |          | GJXU.F        | 1387 | GJWU.F   | 1566 |
| Modesty-Access: 42   | 42 |   |          | GJXU.G        | 1435 | GJWU.G   | 1616 |
| Modesty-Access: 48   | 48 |   |          | GJXU.H        | 1495 | GJWU.H   | 1677 |
| Modesty-Access: 54   | 54 |   |          | GJXU.J        | 1541 | GJWU.J   | 1723 |
| Modesty-Access: 72   | 72 |   |          | GJXU.M        | 1723 | GJWU.M   | 1913 |

! Notes:

Unit is exact width with two 3 inch deep spacers for mounting to L-Panels or Pedestals.

Panels are available with unfinished backs.

Clearance between work surface and panel is 2.5.

Shipping address for COM/COL materials and memo samples:

TUOHY Furniture Corporation, P1 Upholstery Receiving, 42 Saint Albans Place, Chatfield, MN 55923



Specify: Product Number  
Quantity  
Tagging  
Wood Finish  
Hardware Finish

• Denotes Item is illustrated.  
‡ Requires field sub-assembly.

Metal finish is MBN Brushed Nickel.

Prices listed in Wood1 Finishes.

Pedestals 28h, 0.5 Base Trim

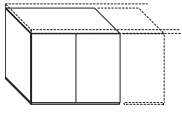

|                        |            | ProdNo. | List \$ | ProdNo. | List \$ | ProdNo. | List \$ |
|------------------------|------------|---------|---------|---------|---------|---------|---------|
| 28.4h BaseTrim         | Back       | 24d     |         | 30d     |         | 36d     |         |
| Ped 28h BaseTrim       | Unfinished | GKAU24- | 517     | GKAU30- | 558     | GKAU36- | 591     |
| Ped 28h BaseTrim FinBk | Finished   | GKAF24- | 517     | GKAF30- | 558     | GKAF36- | 591     |

| Pedestal Menu       | w  |     |      | Unfinished Back<br>24d | Unfinished Back<br>30d | Unfinished Back<br>36d | Finished Back<br>Add \$ |      |
|---------------------|----|-----|------|------------------------|------------------------|------------------------|-------------------------|------|
| Shelving 15         | 15 | B   | 2217 | —                      | —                      | —                      | +71                     |      |
| Shelving 18         | 18 | C   | 2351 | —                      | —                      | —                      | +90                     |      |
| Shelving 30         | 30 | E   | 2724 | —                      | —                      | —                      | +162                    |      |
| Shelving 36         | 36 | F   | 2913 | —                      | —                      | —                      | +190                    |      |
| Cabinet-LH 15       | 15 | N   | 2930 | —                      | —                      | —                      | +71                     |      |
| Cabinet-LH 18       | 18 | P   | 3121 | —                      | —                      | —                      | +90                     |      |
| Cabinet-RH 15       | 15 | R   | 2930 | —                      | —                      | —                      | +71                     |      |
| Cabinet-RH 18       | 18 | S   | 3121 | —                      | —                      | —                      | +90                     |      |
| Double Cabinet 30   | 30 | U   | 3606 | —                      | —                      | —                      | +162                    |      |
| • Double Cabinet 36 | 36 | V   | 3697 | —                      | —                      | —                      | +190                    |      |
| 2File 18            | 18 | W   | 3792 | W                      | 3861                   | W                      | 3975                    | +192 |
| 2Box/File 18        | 18 | Y   | 3983 | Y                      | 4056                   | Y                      | 4185                    | +192 |
| 4Box 18             | 18 | 0   | 4174 | 0                      | 4255                   | 0                      | 4392                    | +192 |
| 2LatFile 30         | 30 | 2   | 4238 | —                      | —                      | —                      | +308                    |      |
| 2LatFile 36         | 36 | 3   | 4339 | —                      | —                      | —                      | +343                    |      |
| 2LatBox/LatFile 30  | 30 | 6   | 4434 | —                      | —                      | —                      | +308                    |      |
| 2LatBox/LatFile 36  | 36 | 7   | 4917 | —                      | —                      | —                      | +343                    |      |
| LatBox/DbiCab 30    | 30 | 8   | 4680 | —                      | —                      | —                      | +162                    |      |
| LatBox/DbiCab 36    | 36 | 9   | 4820 | —                      | —                      | —                      | +190                    |      |
| Open Kneespace      |    | (#) | —    | (#)                    | —                      | (#)                    | —                       |      |
| # = inches required |    |     |      |                        |                        |                        |                         |      |

See Notes and Options on the following page.

How to Order Pedestals:

Choose the pedestal format desired from each of the listings above and on the opposite page. Note the ProductNo. and List \$ that correspond to the depth and back (finished/unfinished) desired. Follow the ProductNo. column down until you have located the first (left-most) pedestal desired, then append the letter/number code to the original item number and add the price to the original price. Continue adding pedestals in this manner until your unit is complete.

The overall pedestal width will be the accumulated widths of all pedestals chosen; the overall price will be the accumulated prices and the final item number will be the original number plus all of the letter codes for the pedestals added. Maximum width under one top is 120 inches. Components are modular and may require field assembly. Finished backs may be segmented; inquire if a continuous back is required. Verify all logistical dimensions (e.g., elevators, corridors and doorways) prior to ordering large units. Tops are to be ordered separately.

See also the information on the following pages.

Sample Order

0.5 Base, 24d, 2BF + LatFile,  
Finished Back

| w  | ProdNo. | List \$ | Add  |
|----|---------|---------|------|
| -- | GKAF24- | 469     | --   |
| 18 | Y       | 3612    | +174 |
| 36 | 3       | 3935    | +311 |

GKAF24-Y3 = \$8501 (List Price)

Specify: Product Number  
Quantity  
Tagging  
Wood Finish  
Hardware Finish

• Denotes Item is illustrated.  
‡ Requires field sub-assembly.

Metal finish is MBN Brushed Nickel.

Prices listed in Wood1 Finishes.

Pedestals 28h, 3.5 Base

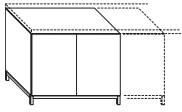

|                        |            | ProdNo. | List \$ | ProdNo. | List \$ | ProdNo. | List \$ |
|------------------------|------------|---------|---------|---------|---------|---------|---------|
| 28.4h 3.5 Base         | Back       | 24d     |         | 30d     |         | 36d     |         |
| Ped 28h 3.5 Base       | Unfinished | GKBU24- | 701     | GKBU30- | 776     | GKBU36- | 819     |
| Ped 28h 3.5 Base FinBk | Finished   | GKBF24- | 701     | GKBF30- | 776     | GKBF36- | 819     |

| Pedestal Menu →    | w  | ↑                   |                     | ↑                   |               | ↑   |      | Finished Back Add \$ |
|--------------------|----|---------------------|---------------------|---------------------|---------------|-----|------|----------------------|
|                    |    | Unfinished Back 24d | Unfinished Back 30d | Unfinished Back 36d | Finished Back |     |      |                      |
| Shelving 15        | 15 | B                   | 3524                | —                   | —             | —   | —    | +68                  |
| Shelving 18        | 18 | C                   | 3704                | —                   | —             | —   | —    | +86                  |
| Shelving 30        | 30 | E                   | 4065                | —                   | —             | —   | —    | +154                 |
| Shelving 36        | 36 | F                   | 4238                | —                   | —             | —   | —    | +180                 |
| Cabinet-LH 15      | 15 | N                   | 3911                | —                   | —             | —   | —    | +68                  |
| Cabinet-LH 18      | 18 | P                   | 4083                | —                   | —             | —   | —    | +86                  |
| Cabinet-RH 15      | 15 | R                   | 3911                | —                   | —             | —   | —    | +68                  |
| Cabinet-RH 18      | 18 | S                   | 4083                | —                   | —             | —   | —    | +86                  |
| Double Cabinet 30  | 30 | U                   | 4690                | —                   | —             | —   | —    | +154                 |
| Double Cabinet 36  | 36 | V                   | 4807                | —                   | —             | —   | —    | +180                 |
| 2File 18           | 18 | W                   | 4917                | W                   | 4995          | W   | 5111 | +183                 |
| 2Box/File 18       | 18 | Y                   | 5117                | Y                   | 5194          | Y   | 5321 | +183                 |
| 4Box 18            | 18 | 0                   | 5314                | 0                   | 5383          | 0   | 5527 | +183                 |
| 2LatFile 30        | 30 | 2                   | 5465                | —                   | —             | —   | —    | +293                 |
| 2LatFile 36        | 36 | 3                   | 5644                | —                   | —             | —   | —    | +327                 |
| 2LatBox/LatFile 30 | 30 | 6                   | 5664                | —                   | —             | —   | —    | +293                 |
| 2LatBox/LatFile 36 | 36 | 7                   | 6222                | —                   | —             | —   | —    | +327                 |
| LatBox/DbfCab 30   | 30 | 8                   | 5905                | —                   | —             | —   | —    | +154                 |
| LatBox/DbfCab 36   | 36 | 9                   | 6119                | —                   | —             | —   | —    | +180                 |
| Open Kneespace     |    | (#)                 | —                   | (#)                 | —             | (#) | —    |                      |

- ! Notes—for all Pedestals on this and opposite page.  
 Maximum width under one top is 120 inches; components are modular and may require field assembly.  
 Finished backs may be segmented; inquire if a continuous back is required.  
 Verify all logistical dimensions (e.g., elevators, corridors and doorways) prior to ordering large units.  
 Prices shown here regard Wood1 finishes; note surcharges for Wood2 finish.  
 Geneva pedestals are not modular. Faces and back panels are each made from single pieces of veneer to guarantee consistency of grain and color.  
 Pedestals have a kerf detail along edges and vertical corners.  
 All pedestals include locks where applicable.

- + Options:  
 For drawers/cabinets with Silex (faux leather), specify Option LF and add \$960 per drawer/door face.  
 For drawers/cabinets with Stitched Silex, specify Option SF and add \$1306 per drawer/door face.

To Specify Pedestals

- Construct the Product Number and List Price:  
 Choose the format desired and note the starting Prefix Code and List \$ for the depth required.  
 Specify pedestal sequence L to R by adding the Ped Code and \$ for the depth required to the Prefix Code and List \$.  
 The overall width is the sum of the pedestal widths you have added (120 is maximum).
- Required Specifications  
 Product number and price.  
 Quantity and Tagging information.  
 Wood finish selection.  
 Silex color selection if applicable.
- Options, as listed above.

Specify: Product Number  
 Quantity  
 Tagging  
 Wood Finish  
 Hardware Finish

• Denotes Item is illustrated.  
 ‡ Requires field sub-assembly.

Metal finish is MBN Brushed Nickel.

Prices listed in Wood1 Finishes.

Pedestals 40h/54h, 0.5 Base Trim

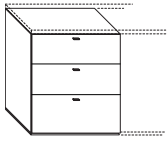

|                         |            |         | ProdNo.                | List \$ |     |     |                         |
|-------------------------|------------|---------|------------------------|---------|-----|-----|-------------------------|
| 40.5h                   | Back       | 24d     |                        |         | 30d | 36d |                         |
| Pedestal 40h Base       | Unfinished | GKCU24- | 517                    |         |     |     |                         |
| Pedestal 40h Base FinBk | Finished   | GKCF24- | 517                    |         |     |     |                         |
| Pedestal Menu ↵         | w          |         | Unfinished Back<br>24d |         |     |     | Finished Back<br>Add \$ |
| 3LatFile 30             | 30         | H       | 5839                   |         | —   | —   | +464                    |
| 3LatFile 36             | 36         | J       | 5937                   |         | —   | —   | +509                    |

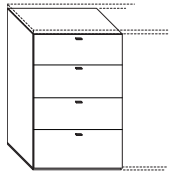

|                         |            |         |                        |  |   |   |                         |
|-------------------------|------------|---------|------------------------|--|---|---|-------------------------|
| 54.5h BaseTrim          | Back       | 24d     |                        |  |   |   |                         |
| Pedestal 54h Base       | Unfinished | GKDU24- | 517                    |  |   |   |                         |
| Pedestal 54h Base FinBk | Finished   | GKDF24- | 517                    |  |   |   |                         |
| Pedestal Menu ↵         | w          |         | Unfinished Back<br>24d |  |   |   | Finished Back<br>Add \$ |
| 4LatFile 30             | 30         | K       | 7594                   |  | — | — | +522                    |
| 4LatFile 36             | 36         | L       | 7799                   |  | — | — | +578                    |

Pedestals 40h/54h, 3.5 Base

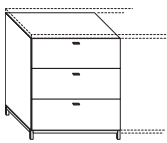

|                    |            |         |                        |  |   |   |                         |
|--------------------|------------|---------|------------------------|--|---|---|-------------------------|
| 40.5h              | Back       | 24d     |                        |  |   |   |                         |
| Pedestal 40h       | Unfinished | GKEU24- | 701                    |  |   |   |                         |
| Pedestal 40h FinBk | Finished   | GKEF24- | 701                    |  |   |   |                         |
| Pedestal Menu ↵    | w          |         | Unfinished Back<br>24d |  |   |   | Finished Back<br>Add \$ |
| 3LatFile 30        | 30         | H       | 7070                   |  | — | — | +464                    |
| 3LatFile 36        | 36         | J       | 7241                   |  | — | — | +509                    |

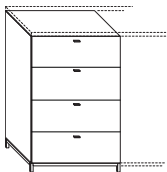

|                         |            |         |                        |  |   |   |                         |
|-------------------------|------------|---------|------------------------|--|---|---|-------------------------|
| 54.5h BaseTrim          | Back       | 24d     |                        |  |   |   |                         |
| Pedestal 54h Base       | Unfinished | GKFU24- | 701                    |  |   |   |                         |
| Pedestal 54h Base FinBk | Finished   | GKFF24- | 701                    |  |   |   |                         |
| Pedestal Menu ↵         | w          |         | Unfinished Back<br>24d |  |   |   | Finished Back<br>Add \$ |
| 4LatFile 30             | 30         | K       | 8817                   |  | — | — | +522                    |
| 4LatFile 36             | 36         | L       | 9102                   |  | — | — | +578                    |

- ! Notes—for Pedestals on this page.  
Maximum width under one top is 120 inches; components are modular and may require field assembly. Finished backs will be segmented; inquire if a continuous back is required. Verify all logistical dimensions (e.g., elevators, corridors and doorways) prior to ordering large units. Prices shown here regard Wood1 finishes; note surcharges for Wood2 finish. Geneva 3 and 4 high pedestals are shipped in logical components. Faces and back panels are each made from single pieces of veneer to guarantee consistency of grain and color. All pedestals include locks. Credenza Tops for spanning a run of pedestals are listed on a prior page and must be ordered separately. Drawer Pedestals 40/54h must be secured on location to the wall; otherwise, specify Option AT below.
- + Options:  
For Anti-Tilt Mechanisms, specify Option AT; add 1028.  
For drawers/cabinets with Silex (faux leather), specify Option LF and add \$960 per drawer/door face.  
For drawers/cabinets with Stitched Silex, specify Option SF and add \$1306 per drawer/door face.

Specify: Product Number  
Quantity  
Tagging  
Wood Finish  
Hardware Finish

• Denotes Item is illustrated.  
‡ Requires field sub-assembly.

Metal finish is MBN Brushed Nickel.

Prices listed in Wood1 Finishes.

Pedestals, Mobile

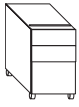

|                     |               | Product No.       | List \$ | Product No.       | List \$ |
|---------------------|---------------|-------------------|---------|-------------------|---------|
| Mobile              | 18w 24d 27.2h | Use with 0.5 Base |         | Use with 3.5 Base |         |
| PedMobile24: 2BF 18 |               | GKUF.CD           | 4690    | GKHF.CD           | 4601    |

! Notes:

- Locks are included.
- Drawers are 0.5 Birch with dovetailed corners.
- Drawer bottoms are 0.25 inch thick dadoed into drawer sides.
- Slides are ball bearing full extension.
- Box drawers come with drawer dividers.
- File drawers come with Pendaflex file hanging system.
- Units have a 20 deep drawer and are finished on all sides.

Hutches, Wood Shelving1

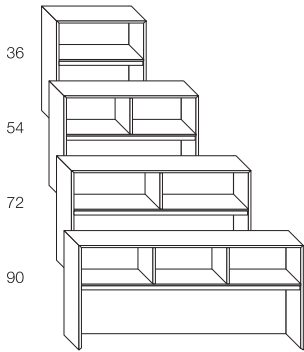

| 42.1h (72h installed)    |    | w  | 15d | Shv | COM      | Fabric Back Panel | Wood Back Panel |      |
|--------------------------|----|----|-----|-----|----------|-------------------|-----------------|------|
| • Hutch72: WoodShelving1 | 36 | 36 | 0\1 | 1.8 | GLAF.FBM | 6026              | GLAW.FBM        | 5262 |
| • Hutch72: WoodShelving1 | 54 | 54 | 1\1 | 2   | GLAF.JBM | 7130              | GLAW.JBM        | 6217 |
| • Hutch72: WoodShelving1 | 72 | 72 | 0\2 | 2.3 | GLAF.MBM | 8229              | GLAW.MBM        | 7170 |
| • Hutch72: WoodShelving1 | 90 | 90 | 1\2 | 2.8 | GLAF.PBM | 9332              | GLAW.PBM        | 8128 |

| 42.1h w/Cubby (72h installed) |    | w  | 15d | Shv | COM      | Fabric Back Panel | Wood Back Panel |       |
|-------------------------------|----|----|-----|-----|----------|-------------------|-----------------|-------|
| Hutch72: WdShelv1/Cubby       | 36 | 36 | 0\1 | 1.8 | GLBF.FBM | 6996              | GLBW.FBM        | 6196  |
| Hutch72: WdShelv1/Cubby       | 54 | 54 | 1\1 | 2   | GLBF.JBM | 8424              | GLBW.JBM        | 7466  |
| Hutch72: WdShelv1/Cubby       | 72 | 72 | 0\2 | 2.3 | GLBF.MBM | 10121             | GLBW.MBM        | 9004  |
| Hutch72: WdShelv1/Cubby       | 90 | 90 | 1\2 | 2.8 | GLBF.PBM | 11442             | GLBW.PBM        | 10169 |

! Notes:

Units have a 3 grade top surface.  
 Units have an unfinished back and are designed to go up against a wall.  
 Fabric/Wood Back Panels are removable for wire access and management.  
 The back of the units have a cord access cutout located 2.5 up from the bottom.  
 The removable back panel has 0.5 clearance at the bottom and 0.75 clearance at the top.  
 Dividers: None at 36w; one at 54-72w; two at 90.

Hutches, Wood Shelving Full Height

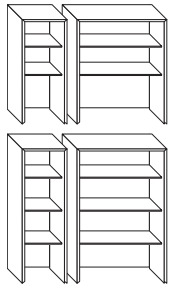

| 42.1h (72h installed)    |    | w  | 15d | Shv |  | Wood Back Panel |      |
|--------------------------|----|----|-----|-----|--|-----------------|------|
| • Hutch72: WoodShelving3 | 18 | 18 | 3\0 |     |  | GLEW.CBM        | 4373 |
| • Hutch72: WoodShelving3 | 36 | 36 | 0\3 |     |  | GLEW.FBM        | 5904 |

| 55.1h (85h installed)    |    | w  | 15d | Shv |  | Wood Back Panel |      |
|--------------------------|----|----|-----|-----|--|-----------------|------|
| • Hutch85: WoodShelving4 | 18 | 18 | 4\0 |     |  | GLEW.CB8        | 5129 |
| • Hutch85: WoodShelving4 | 36 | 36 | 0\4 |     |  | GLEW.FB8        | 6809 |

! Notes:

Units have a 3 grade top surface.  
 Units have an unfinished back and are designed to go up against a wall.  
 Number of adjustable shelves varies approximately on 14 inch openings.

Hutches, Paper Management

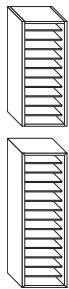

| 42.1h (72h installed)   |     | 18w | d  | Shv | Glass Shelves | Wood Shelves |          |      |
|-------------------------|-----|-----|----|-----|---------------|--------------|----------|------|
| • Hutch72: PaperManager | 15d | 15  | 11 |     | GLNW.CBM      | 7724         | GLPW.CBM | 5811 |
| • Hutch72: PaperManager | 18d | 18  | 11 |     | GLNW.CCM      | 8576         | GLPW.CCM | 6111 |

| 55.1h (85h installed)   |     | 18w | d  | Shv | Glass Shelves | Wood Shelves |          |      |
|-------------------------|-----|-----|----|-----|---------------|--------------|----------|------|
| • Hutch85: PaperManager | 15d | 15  | 14 |     | GLNW.CB8      | 9784         | GLPW.CB8 | 7317 |
| • Hutch85: PaperManager | 18d | 18  | 14 |     | GLNW.CC8      | 10577        | GLPW.CC8 | 7704 |

! Notes:

Units have a 3 grade top surface and wood back panel.  
 Units have an unfinished back and are designed to go up against a wall.  
 Glass Shelves are 0.25 inch thick and spaced 3.78 inches (96mm) on center vertically.  
 Wood Shelves are 0.5 inch thick and spaced 3.78 inches (96mm) on center vertically.

Shipping address for COM/COL materials and memo samples:  
 TUOHY Furniture Corporation, P1 Upholstery Receiving, 42 Saint Albans Place, Chatfield, MN 55923



Specify: Product Number      • Denotes Item is illustrated.  
 Quantity  
 Tagging  
 Wood Finish  
 Hardware Finish

Prices listed in Wood1 Finishes.

Hutches, Cabinet1

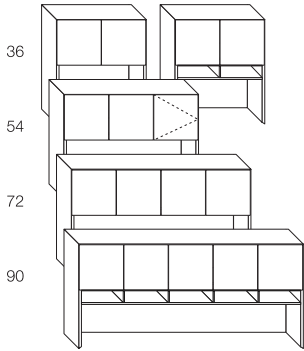

| 42.1h (72h installed)  | w  | 15d | Shv | COM      | Fabric Back Panel | Wood Back Panel |
|------------------------|----|-----|-----|----------|-------------------|-----------------|
| • Hutch72: Cabinet1 36 | 36 | 0\1 | 1.8 | GLFF.FBM | 6391              | GLFW.FBM 5814   |
| • Hutch72: Cabinet1 54 | 54 | 1\1 | 2   | GLFF.JBM | 8419              | GLFW.JBM 7474   |
| • Hutch72: Cabinet1 72 | 72 | 0\2 | 2.3 | GLFF.MBM | 9427              | GLFW.MBM 8420   |
| Hutch72: Cabinet1 90   | 90 | 1\2 | 2.8 | GLFF.PBM | 10184             | GLFW.PBM 9033   |

| 42.1h w/Cubby (72h installed) | w  | 15d | Shv | COM      | Fabric Back Panel | Wood Back Panel |
|-------------------------------|----|-----|-----|----------|-------------------|-----------------|
| • Hutch72: Cabinet1/Cubby 36  | 36 | 0\1 | 1.8 | GLGF.FBM | 7351              | GLGW.FBM 6740   |
| Hutch72: Cabinet1/Cubby 54    | 54 | 1\1 | 2   | GLGF.JBM | 9731              | GLGW.JBM 8749   |
| Hutch72: Cabinet1/Cubby 72    | 72 | 0\2 | 2.3 | GLGF.MBM | 11305             | GLGW.MBM 10240  |
| • Hutch72: Cabinet1/Cubby 90  | 90 | 1\2 | 2.8 | GLGF.PBM | 12252             | GLGW.PBM 11045  |

+ Options:

For Silex-wrapped doors, specify Opton LF and add \$960 per door.  
 For StitchedSilex-wrapped doors, specify Opton SF and add \$1306 per door.

! Notes:

Units have a 3 grade top surface.  
 Units have an unfinished back and are designed to go up against a wall.  
 Units are available with either a COM fabric panel or wood panel. These panels are removable and are used to cover cord access.  
 The back of the units have a cord access cutout located 2.5 up from the bottom.  
 The removable back panel has 0.5 clearance at the bottom and 0.75 clearance at the top.

Hutches, Cabinet2

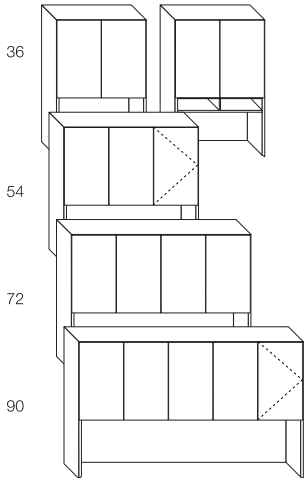

| 55.1h (85 installed)   | w  | 15d | Shv | COM      | Fabric Back Panel | Wood Back Panel |
|------------------------|----|-----|-----|----------|-------------------|-----------------|
| • Hutch85: Cabinet2 36 | 36 | 0\2 | 1.8 | GLHF.FB8 | 7319              | GLHW.FB8 6741   |
| • Hutch85: Cabinet2 54 | 54 | 2\2 | 2   | GLHF.JB8 | 9422              | GLHW.JB8 8488   |
| • Hutch85: Cabinet2 72 | 72 | 0\4 | 2.3 | GLHF.MB8 | 10503             | GLHW.MB8 9496   |
| • Hutch85: Cabinet2 90 | 90 | 2\4 | 2.8 | GLHF.PB8 | 11334             | GLHW.PB8 10184  |

| 55.1h w/Cubby (85 installed) | w  | 15d | Shv | COM      | Fabric Back Panel | Wood Back Panel |
|------------------------------|----|-----|-----|----------|-------------------|-----------------|
| • Hutch85: Cabinet2/Cubby 36 | 36 | 0\2 | 1.8 | GLJF.FB8 | 8330              | GLJW.FB8 7719   |
| Hutch85: Cabinet2/Cubby 54   | 54 | 2\2 | 2   | GLJF.JB8 | 10788             | GLJW.JB8 9804   |
| Hutch85: Cabinet2/Cubby 72   | 72 | 0\4 | 2.3 | GLJF.MB8 | 12434             | GLJW.MB8 11378  |
| Hutch85: Cabinet2/Cubby 90   | 90 | 2\4 | 2.8 | GLJF.PB8 | 13460             | GLJW.PB8 12252  |

+ Options:

For Silex-wrapped doors, specify Opton LF and add \$960 per door.  
 For StitchedSilex-wrapped doors, specify Opton SF and add \$1306 per door.

! Notes:

Units have a 3 grade top surface.  
 Units have an unfinished back and are designed to go up against a wall.  
 Units are available with either a COM fabric panel or wood panel. These panels are removable and are used to cover cord access.  
 The back of the units have a cord access cutout located 2.5 up from the bottom.  
 The removable back panel has 0.5 clearance at the bottom and 0.75 clearance at the top.

Hutches, Full Height Cabinet

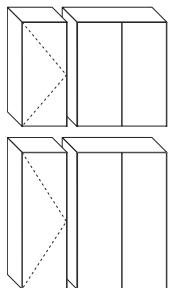

| 42.1h (72 installed)      | w  | 15d | Shv | Wood Back Panel |
|---------------------------|----|-----|-----|-----------------|
| Hutch72: Cabinet3 LH 18   | 18 | 3\0 |     | GLKW.CBM 4811   |
| • Hutch72: Cabinet3 RH 18 | 18 | 3\0 |     | GLLW.CBM 4811   |
| • Hutch72: Cabinet3 36    | 36 | 0\3 |     | GLMW.FBM 6710   |

| 55.1h (85 installed)      | w  | 15d | Shv | Wood Back Panel |
|---------------------------|----|-----|-----|-----------------|
| Hutch85: Cabinet4 LH 18   | 18 | 4\0 |     | GLKW.CB8 5679   |
| • Hutch85: Cabinet4 RH 18 | 18 | 4\0 |     | GLLW.CB8 5679   |
| • Hutch85: Cabinet4 36    | 36 | 0\4 |     | GLMW.FB8 7646   |

+ Options:

For Silex-wrapped doors, specify Opton LF and add \$960 per door.  
 For StitchedSilex-wrapped doors, specify Opton SF and add \$1306 per door.

! Notes:

Units have a 3 grade top surface.  
 Units have an unfinished back and are designed to go up against a wall.  
 Number of adjustable shelves varies approximately on 14 inch openings.

Shipping address for COM/COL materials and memo samples:  
 TUOHY Furniture Corporation, P1 Upholstery Receiving, 42 Saint Albans Place, Chatfield, MN 55923



Specify: Product Number      • Denotes Item is illustrated.  
 Quantity  
 Tagging  
 Wood Finish  
 Hardware Finish

Prices listed in Wood1 Finishes.

Wall Hutches, Shelving & Cabinet

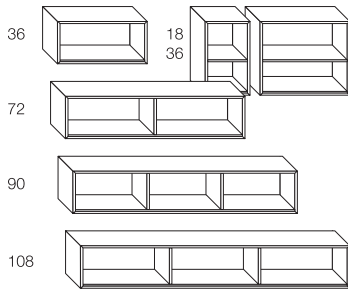

| 18h/24.25h (Wall Cleat Included)   |  |  | w   | 15d | Sgl\Tbl Shelf | Wall Hutch, 18h            | Product No. | List \$ | Product No. | List \$ |
|------------------------------------|--|--|-----|-----|---------------|----------------------------|-------------|---------|-------------|---------|
| • WallHutch: WoodShelf1 36         |  |  | 36  | 0\1 |               | Wall Hutch w/Cubby, 24.25h | GMA.FB      | 3537    | GMB.FB      | 4350    |
| • WallHutch: WoodShelf1 72         |  |  | 72  | 0\2 |               |                            | GMA.MB      | 6018    | GMB.MB      | 7720    |
| • WallHutch: WoodShelf1 90         |  |  | 90  | 0\3 |               |                            | GMA.PB      | 7020    | GMB.PB      | 8931    |
| • WallHutch: WoodShelf1 108        |  |  | 108 | 0\3 |               |                            | GMA.RB      | 8366    | GMB.RB      | 10482   |
| 30.6h/37.25h (Wall Cleat Included) |  |  | w   | 15d | Sgl\Tbl Shelf | Wall Hutch, 30.6h          | Product No. | List \$ | Product No. | List \$ |
| • WallHutch: WoodShelf2 18         |  |  | 18  | 2\0 |               | Wall Hutch w/Cubby, 37.25h | GMC.FB      | 3176    | GMD.FB      | 3750    |
| • WallHutch: WoodShelf2 36         |  |  | 36  | 0\2 |               |                            | GMC.MB      | 4957    | GMD.MB      | 6098    |
| • WallHutch: WoodShelf2 72         |  |  | 72  | 0\4 |               |                            | GMC.PB      | 8552    | GMD.PB      | 10381   |
| • WallHutch: WoodShelf2 90         |  |  | 90  | 0\6 |               |                            | GMC.RB      | 9899    | GMD.RB      | 11954   |

! Notes:

Units have a 3-grade top surface.

Dividers: None through 36w; one at 72w; two at 90 or more.

Wall-mount cleats are included for field installation; wall hutches must be screwed through the back into the wall cleat.

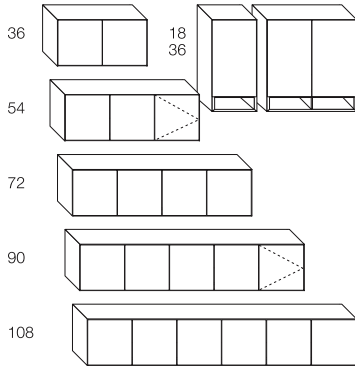

| 18h/24.25h (Wall Cleat Included)   |  |  | w   | 15d | Sgl\Tbl Shelf | Wall Hutch, 18h            | Product No. | List \$ | Product No. | List \$ |
|------------------------------------|--|--|-----|-----|---------------|----------------------------|-------------|---------|-------------|---------|
| • WallHutch: Cabinet1 36           |  |  | 36  | 0\1 |               | Wall Hutch w/Cubby, 24.25h | GMF.FB      | 4323    | GMG.FB      | 5177    |
| • WallHutch: Cabinet1 54           |  |  | 54  | 1\1 |               |                            | GMF.JB      | 6437    | GMG.JB      | 7650    |
| • WallHutch: Cabinet1 72           |  |  | 72  | 0\2 |               |                            | GMF.MB      | 7464    | GMG.MB      | 9241    |
| • WallHutch: Cabinet1 90           |  |  | 90  | 1\2 |               |                            | GMF.PB      | 8582    | GMG.PB      | 10421   |
| • WallHutch: Cabinet1 108          |  |  | 108 | 0\3 |               |                            | GMF.RB      | 9488    | GMG.RB      | 11661   |
| 30.6h/37.25h (Wall Cleat Included) |  |  | w   | 15d | Sgl\Tbl Shelf | Wall Hutch, 30.6h          | Product No. | List \$ | Product No. | List \$ |
| • WallHutch: Cabinet2 LH 18        |  |  | 18  | 2\0 |               | Wall Hutch w/Cubby, 37.25h | GMN.CB      | 3476    | GMP.CB      | 4065    |
| • WallHutch: Cabinet2 RH 18        |  |  | 18  | 2\0 |               |                            | GMQ.CB      | 3476    | GMR.CB      | 4065    |
| • WallHutch: Cabinet2 36           |  |  | 36  | 0\2 |               |                            | GMH.FB      | 5437    | GMJ.FB      | 6347    |
| • WallHutch: Cabinet2 54           |  |  | 54  | 2\2 |               |                            | GMH.JB      | 7369    | GMJ.JB      | 8639    |
| • WallHutch: Cabinet2 72           |  |  | 72  | 0\4 |               |                            | GMH.MB      | 9667    | GMJ.MB      | 11559   |
| • WallHutch: Cabinet2 90           |  |  | 90  | 2\4 |               |                            | GMH.PB      | 11120   | GMJ.PB      | 13080   |

+ Options:

For Silex-wrapped doors, specify Opton LF and add \$960 per door.

For StitchedSilex-wrapped doors, specify Opton SF and add \$1306 per door.

! Notes:

Units have a 3-grade top surface.

Wall-mount cleats are included for field installation; hutches must be screwed through the back into the wall cleat.

Fabric Panels, Wall Hung

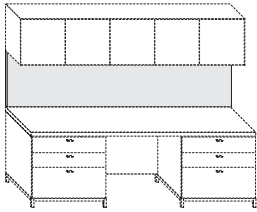

|                                |     |       |     | Product No. | List \$ | Product No.        | List \$ |
|--------------------------------|-----|-------|-----|-------------|---------|--------------------|---------|
| 23.4h (Includes Wall Cleats) ‡ | w   | 23.4h | COM | Wall Hutch  |         | Wall Hutch w/Cubby |         |
| Fabric Wall Panel: 36          | 36  |       | 1.8 | LN-36-23.4  | 574     | LN-36-17.4         | 574     |
| Fabric Wall Panel: 54          | 54  |       | 2   | LN-54-23.4  | 939     | LN-54-17.4         | 939     |
| Fabric Wall Panel: 72          | 72  |       | 2.3 | LN-72-23.4  | 1008    | LN-72-17.4         | 1008    |
| • Fabric Wall Panel: 90        | 90  |       | 2.8 | LN-90-23.4  | 1127    | LN-90-17.4         | 1127    |
| Fabric Wall Panel: 108         | 108 |       | 3.2 | LN-108-23.4 | 1222    | LN-108-17.4        | 1222    |
| 36h (Includes Wall Cleats) ‡   | w   | 36h   | COM | Wall Hutch  |         | Wall Hutch w/Cubby |         |
| Fabric Wall Panel: 36X         | 36  |       | 1.8 | LN-36-36    | 574     | LN-30-30           | 574     |
| Fabric Wall Panel: 54X         | 54  |       | 2   | LN-54-36    | 939     | LN-54-30           | 939     |
| Fabric Wall Panel: 72X         | 72  |       | 2.3 | LN-72-36    | 1008    | LN-72-30           | 1008    |
| Fabric Wall Panel: 90X         | 90  |       | 2.8 | LN-90-36    | 1127    | LN-90-30           | 1127    |
| Fabric Wall Panel: 108X        | 108 |       | 3.2 | LN-108-36   | 1222    | LN-108-30          | 1222    |

! Notes:

- Cord management behind Fabric Panels is feasible.
- For use with Wall Hung Hutches.
- Fabric Panels for Wall Hutches with Shelf Added will be 6 inches shorter in height.
- Fabric Panels over 96w are produced in two sections.

Shipping address for COM/COL materials and memo samples:  
 TUOHY Furniture Corporation, P1 Upholstery Receiving, 42 Saint Albans Place, Chatfield, MN 55923



Specify: Product Number      • Denotes Item is illustrated.  
 Quantity  
 Tagging  
 Wood Finish  
 Hardware Finish

Prices listed in Wood1 Finishes.

Towers, Shelving

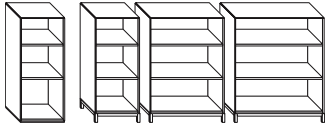

|                            |           | Product No.   | List \$ | Product No. | List \$ |
|----------------------------|-----------|---------------|---------|-------------|---------|
| 42 high                    |           | 0.5 Base Trim |         | 3.5 Base    |         |
| • Tower 42/15: Shelving 18 | w 15d 42h | GPKU.CBG      | 5417    | GPAU.CBG    | 6238    |
| • Tower 42/15: Shelving 30 | 30        | GPKU.EBG      | 6050    | GPAU.EBG    | 6888    |
| • Tower 42/15: Shelving 36 | 36        | GPKU.FBG      | 6338    | GPAU.FBG    | 7218    |

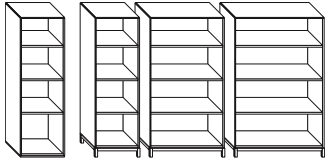

|                            |           |               |      |          |      |
|----------------------------|-----------|---------------|------|----------|------|
| 56 high                    |           | 0.5 Base Trim |      | 3.5 Base |      |
| • Tower 56/15: Shelving 18 | w 15d 56h | GPKU.CB6      | 5857 | GPAU.CB6 | 6677 |
| • Tower 56/15: Shelving 30 | 30        | GPKU.EB6      | 6717 | GPAU.EB6 | 7545 |
| • Tower 56/15: Shelving 36 | 36        | GPKU.FB6      | 7091 | GPAU.FB6 | 7968 |

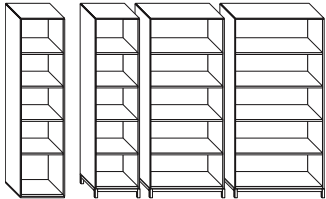

|                            |           |               |      |          |      |
|----------------------------|-----------|---------------|------|----------|------|
| 72 high                    |           | 0.5 Base Trim |      | 3.5 Base |      |
| • Tower 72/15: Shelving 18 | w 15d 72h | GPKU.CBM      | 6293 | GPAU.CBM | 7112 |
| • Tower 72/15: Shelving 30 | 30        | GPKU.EBM      | 7355 | GPAU.EBM | 8187 |
| • Tower 72/15: Shelving 36 | 36        | GPKU.FBM      | 7807 | GPAU.FBM | 8688 |

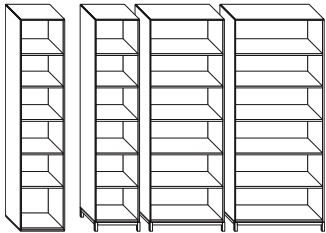

|                            |           |               |      |          |      |
|----------------------------|-----------|---------------|------|----------|------|
| 85 high                    |           | 0.5 Base Trim |      | 3.5 Base |      |
| • Tower 85/15: Shelving 18 | w 15d 85h | GPKU.CB8      | 6761 | GPAU.CB8 | 7578 |
| • Tower 85/15: Shelving 30 | 30        | GPKU.EB8      | 8033 | GPAU.EB8 | 8870 |
| • Tower 85/15: Shelving 36 | 36        | GPKU.FB8      | 8593 | GPAU.FB8 | 9475 |

! Notes:

- Number of adjustable shelves: 2 @ 42h, 3 @ 56h, 4 @ 72h, and 5 @ 85h.
- Units 72 and taller have a 3 grade top surface.
- Unfinished backs are standard.

Towers, Cabinet Single Door



|                |                            |    |    | Product No.   | List \$ | Product No. | List \$ |
|----------------|----------------------------|----|----|---------------|---------|-------------|---------|
| <b>72 high</b> |                            |    |    | 0.5 Base Trim |         | 3.5 Base    |         |
| •              | Tower 72/15: Cabinet LH 18 | 18 | 15 | GPLU.CBM      | 6486    | GPBU.CBM    | 7310    |
|                | Tower 72/15: Cabinet RH 18 | 18 | 15 | GPMU.CBM      | 6486    | GPCU.CBM    | 7310    |
|                | Tower 72/15: Cabinet LH 24 | 24 | 15 | GPLU.DBM      | 7448    | GPBU.DBM    | 8278    |
|                | Tower 72/15: Cabinet RH 24 | 24 | 15 | GPMU.DBM      | 7448    | GPCU.DBM    | 8278    |
| •              | Tower 72/24: Cabinet LH 18 | 18 | 24 | GPLU.CDM      | 7001    | GPBU.CDM    | 7881    |
|                | Tower 72/24: Cabinet RH 18 | 18 | 24 | GPMU.CDM      | 7001    | GPCU.CDM    | 7881    |
|                | Tower 72/24: Cabinet LH 24 | 24 | 24 | GPLU.DDM      | 8025    | GPBU.DDM    | 8955    |
|                | Tower 72/24: Cabinet RH 24 | 24 | 24 | GPMU.DDM      | 8025    | GPCU.DDM    | 8955    |
| <b>85 high</b> |                            |    |    | 0.5 Base Trim |         | 3.5 Base    |         |
| •              | Tower 85/15: Cabinet LH 18 | 18 | 15 | GPLU.CB8      | 6892    | GPBU.CB8    | 7715    |
|                | Tower 85/15: Cabinet RH 18 | 18 | 15 | GPMU.CB8      | 6892    | GPCU.CB8    | 7715    |
|                | Tower 85/15: Cabinet LH 24 | 24 | 15 | GPLU.DB8      | 8044    | GPBU.DB8    | 8882    |
|                | Tower 85/15: Cabinet RH 24 | 24 | 15 | GPMU.DB8      | 8044    | GPCU.DB8    | 8882    |
| •              | Tower 85/24: Cabinet LH 18 | 18 | 24 | GPLU.CD8      | 7462    | GPBU.CD8    | 8342    |
|                | Tower 85/24: Cabinet RH 18 | 18 | 24 | GPMU.CD8      | 7462    | GPCU.CD8    | 8342    |
|                | Tower 85/24: Cabinet LH 24 | 24 | 24 | GPLU.DD8      | 8701    | GPBU.DD8    | 9630    |
|                | Tower 85/24: Cabinet RH 24 | 24 | 24 | GPMU.DD8      | 8701    | GPCU.DD8    | 9630    |

+ Options:

For Silex-wrapped doors, specify Opton LF and add \$1204 per door.  
 For StitchedSilex-wrapped doors, specify Opton SF and add \$1905 per door.  
 Locks are optional.

! Notes:

Number of shelves: 1 fixed and 3 adjustable @ 72h, 1 fixed and 3 adjustable @ 85h.  
 Units have 3 grade top surface.  
 Unfinished backs are standard.

Towers, Cabinet Double Door

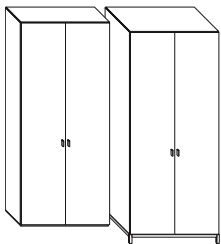
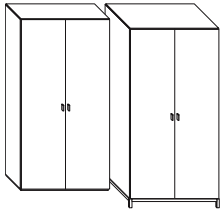

|                |                             | 36w | d  | 72h | 0.5 Base Trim | 3.5 Base |                |
|----------------|-----------------------------|-----|----|-----|---------------|----------|----------------|
| <b>72 high</b> |                             |     |    |     |               |          |                |
| •              | Tower 72/15: Cabinet DBL 36 |     | 15 |     | GPNU.FBM      | 7789     | GPDU.FBM 8668  |
| •              | Tower 72/24: Cabinet DBL 36 |     | 24 |     | GPNU.FDM      | 8459     | GPDU.FDM 9383  |
| <b>85 high</b> |                             |     |    |     |               |          |                |
| •              | Tower 85/15: Cabinet DBL 36 |     | 15 |     | GPNU.FB8      | 8955     | GPDU.FB8 9839  |
| •              | Tower 85/24: Cabinet DBL 36 |     | 24 |     | GPNU.FD8      | 9785     | GPDU.FD8 10709 |

+ Options:

For Silex-wrapped doors, specify Opton LF and add \$1204 per door.  
 For StitchedSilex-wrapped doors, specify Opton SF and add \$1905 per door.  
 Locks are optional.

! Notes:

Number of shelves: 1 fixed and 3 adjustable @ 72h, 1 fixed and 3 adjustable @ 85h.  
 Units have 3 grade top surface.  
 Unfinished backs are standard.

Towers, Garment

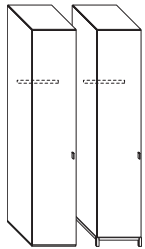
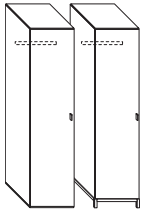

|                              |    |     | Product No. | List \$       | Product No. | List \$       |
|------------------------------|----|-----|-------------|---------------|-------------|---------------|
| 72 high                      | w  | 24d | 72h         | 0.5 Base Trim | 3.5 Base    |               |
| • Tower 72/24: Garment LH 18 | 18 |     |             | GPPU.CDM      | 6249        | GPEU.CDM 7071 |
| Tower 72/24: Garment RH 18   | 18 |     |             | GPQU.CDM      | 6249        | GPFU.CDM 7071 |
| Tower 72/24: Garment LH 24   | 24 |     |             | GPPU.DDM      | 6498        | GPEU.DDM 7332 |
| Tower 72/24: Garment RH 24   | 24 |     |             | GPQU.DDM      | 6498        | GPFU.DDM 7332 |
| 85 high                      | w  | 24d | 85h         | 0.5 Base Trim | 3.5 Base    |               |
| • Tower 85/24: Garment LH 18 | 18 |     |             | GPPU.CD8      | 6705        | GPEU.CD8 7522 |
| Tower 85/24: Garment RH 18   | 18 |     |             | GPQU.CD8      | 6705        | GPFU.CD8 7522 |
| Tower 85/24: Garment LH 24   | 24 |     |             | GPPU.DD8      | 7159        | GPEU.DD8 7988 |
| Tower 85/24: Garment RH 24   | 24 |     |             | GPQU.DD8      | 7159        | GPFU.DD8 7988 |

+ Options:

For Silex-wrapped doors, specify Opton LF and add \$1204 per door.  
 For StitchedSilex-wrapped doors, specify Opton SF and add \$1905 per door.  
 Locks are optional.

! Notes:

Units 85 high have an adjustable shelf above the coat rod.  
 Units have 3 grade top surface.  
 Unfinished backs are standard.

Towers, Garment-Cabinet

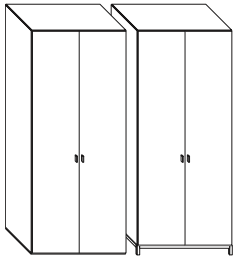
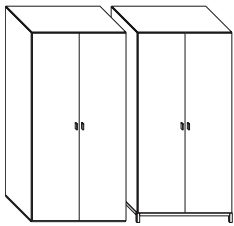

|                               |     |     |     | 0.5 Base Trim | 3.5 Base |               |
|-------------------------------|-----|-----|-----|---------------|----------|---------------|
| 72h                           | 36w | 24d | 72h |               |          |               |
| • Tower 72/24: Garment:Cab 36 |     |     |     | GPRU.FDM      | 8569     | GPGU.FDM 9449 |
| Tower 72/24: Cab:Garment 36   |     |     |     | GPSU.FDM      | 8569     | GPHU.FDM 9449 |

|                               |     |     |     | 0.5 Base Trim | 3.5 Base |                |
|-------------------------------|-----|-----|-----|---------------|----------|----------------|
| 85h                           | 36w | 24d | 85h |               |          |                |
| • Tower 85/24: Garment:Cab 36 |     |     |     | GPRU.FD8      | 9378     | GPGU.FD8 10260 |
| Tower 85/24: Cab:Garment 36   |     |     |     | GPSU.FD8      | 9378     | GPHU.FD8 10260 |

+ Options:

For Silex-wrapped doors, specify Opton LF and add \$1204 per door.  
 For StitchedSilex-wrapped doors, specify Opton SF and add \$1905 per door.  
 Locks are optional.

! Notes:

Number of shelves: 1 fixed and 3 adjustable @ 72h, 1 fixed and 3 adjustable @ 85h.  
 Units 85 high get an additional adjustable shelf above the coat rod.  
 Units have 3 grade top surface.  
 Unfinished backs are standard.

Towers, Cabinet/LatFile

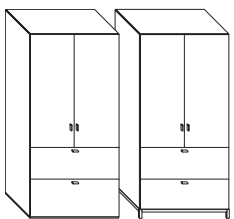

|                            |    |     |     | 0.5 Base Trim | 3.5 Base |                |
|----------------------------|----|-----|-----|---------------|----------|----------------|
| 72h                        | w  | 24d | 72h |               |          |                |
| • Tower 72/24: Cab/LatF 30 | 30 |     |     | GPTU.EDM      | 12014    | GPJU.EDM 12894 |
| Tower 72/24: Cab/LatF 36   | 36 |     |     | GPTU.FDM      | 12141    | GPJU.FDM 13074 |

+ Options:

For Silex-wrapped doors, specify Opton LF and add \$1204 per door.  
 For StitchedSilex-wrapped doors, specify Opton SF and add \$1905 per door.  
 Locks are optional.

! Notes:

Cabinet areas have 2 adjustable shelves.  
 Units have 3 grade top surface.  
 Unfinished backs are standard.

Specify: Product Number  
 Quantity  
 Tagging  
 Wood Finish  
 Hardware Finish

• Denotes Item is illustrated.

Metal finish is MBN Brushed Nickel.

Prices listed in Wood1 Finishes.

Gallery Modules 25d

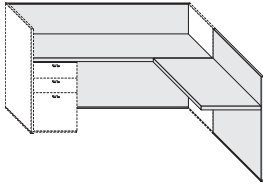

|                        |           | Product No.   | List \$ | Product No. | List \$ |
|------------------------|-----------|---------------|---------|-------------|---------|
| Back Panel and Top 25d | w 25d 42h | 0.5 Base Trim |         | 3.5 Base    |         |
| Gallery Shell: 42x25   | 42        | GSA.GD-       | 3794    | GSB.GD-     | 4309    |
| • Gallery Shell: 48x25 | 48        | GSA.HD-       | 4020    | GSB.HD-     | 4571    |
| Gallery Shell: 54x25   | 54        | GSA.JD-       | 4232    | GSB.JD-     | 4809    |
| Gallery Shell: 60x25   | 60        | GSA.KD-       | 4442    | GSB.KD-     | 5045    |
| Gallery Shell: 66x25   | 66        | GSA.LD-       | 4652    | GSB.LD-     | 5289    |
| • Gallery Shell: 72x25 | 72        | GSA.MD-       | 4878    | GSB.MD-     | 5541    |
| Gallery Shell: 78x25   | 78        | GSA.ND-       | 5084    | GSB.ND-     | 5778    |
| Gallery Shell: 84x25   | 84        | GSA.OD-       | 5324    | GSB.OD-     | 6049    |
| Gallery Shell: 90x25   | 90        | GSA.PD-       | 5530    | GSB.PD-     | 6286    |

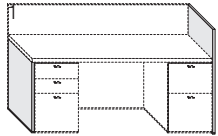

|                               |           |   |      |   |      |
|-------------------------------|-----------|---|------|---|------|
| 1 Gallery End Panel 25d x 42h | +1 to w   | Z | 1299 | Z | 1569 |
| Modules: -                    | 24d 28.4h |   |      |   |      |
| 2 End Panel 24                | 1         | A | 857  | A | 1125 |
| Shelving 15                   | 15        | B | 2505 | B | 3984 |
| 3 Shelving 18                 | 18        | C | 2658 | C | 4187 |
| Shelving 30                   | 30        | E | 3079 | E | 4594 |
| Shelving 36                   | 36        | F | 3292 | F | 4791 |

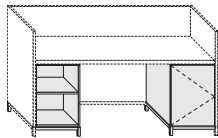

|                   |    |   |      |   |      |
|-------------------|----|---|------|---|------|
| Cabinet-LH 15     | 15 | N | 3311 | N | 4422 |
| Cabinet-LH 18     | 18 | P | 3526 | P | 4616 |
| Cabinet-RH 15     | 15 | R | 3311 | R | 4422 |
| 4 Cabinet-RH 18   | 18 | S | 3526 | S | 4616 |
| Double Cabinet 30 | 30 | U | 4075 | U | 5301 |
| Double Cabinet 36 | 36 | V | 4177 | V | 5433 |

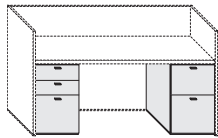

|                  |    |   |      |   |      |
|------------------|----|---|------|---|------|
| 5 2File 18       | 18 | W | 4285 | W | 5559 |
| 6 2Box/File 18   | 18 | Y | 4501 | Y | 5784 |
| 4Box 18          | 18 | 0 | 4720 | 0 | 6005 |
| 2LatFile 30      | 30 | 2 | 4791 | 2 | 6178 |
| 2LatFile 36      | 36 | 3 | 4905 | 3 | 6380 |
| 2LatB/LatFile 30 | 30 | 6 | 5013 | 6 | 6402 |
| 2LatB/LatFile 36 | 36 | 7 | 5559 | 7 | 6917 |

7 Open Kneespace

(#) — (#) —  
# = inches required

Gallery Ordering Information

Choose the Gallery Shell size desired from each of the listings above and on the opposite page; a shell is comprised of a top and a 42h panel. Note the ItemNo and List \$ that correspond to the depth and base treatment desired. Follow the ItemNo column down until you have located the first (left-most) end panel or pedestal desired, then append the letter/number code to the original item number and add the price to the original price. Continue adding modules in this manner until your unit is complete.

The overall unit width will be the accumulated widths of all modules chosen; this dimension cannot be greater than your shell width. The overall price will be the accumulated prices and the final item number will be the original number plus all of the letter codes for the pedestals added.

Gallery Module Sample Order

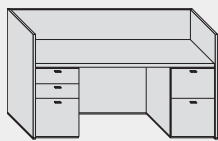

|                                |         |      |
|--------------------------------|---------|------|
| Gallery Shell: 72x25, 0.5 Base | GSA.MD- | 4425 |
| End Gallery Panel              | Z       | 1178 |
| 2Box/File 18w                  | Y       | 4083 |
| Open Kneespace--36 inches      | (36)    | 0    |
| 2File 18w                      | W       | 3887 |
| End Gallery Panel              | Z       | 1178 |

List Price: \$14751

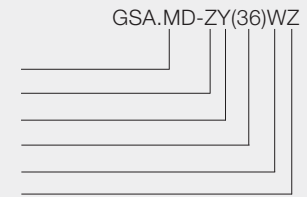

Specify: Product Number  
Quantity  
Tagging  
Wood Finish  
Hardware Finish

• Denotes Item is illustrated.

Metal finish is MBN Brushed Nickel.

Prices listed in Wood1 Finishes.

Gallery Modules 31d

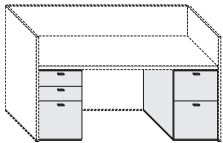
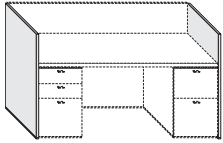
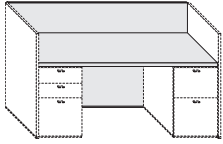

| Gallery Shell        | w  | 31d | 42h | 0.5 Base Trim | 3.5 Base | Product No. | List \$ | Product No. | List \$ |
|----------------------|----|-----|-----|---------------|----------|-------------|---------|-------------|---------|
| Gallery Shell: 42x31 | 42 |     |     |               |          | GSA.GE-     | 3927    | GSB.GE-     | 4461    |
| Gallery Shell: 48x31 | 48 |     |     |               |          | GSA.HE-     | 4163    | GSB.HE-     | 4726    |
| Gallery Shell: 54x31 | 54 |     |     |               |          | GSA.JE-     | 4375    | GSB.JE-     | 4970    |
| Gallery Shell: 60x31 | 60 |     |     |               |          | GSA.KE-     | 4606    | GSB.KE-     | 5233    |
| Gallery Shell: 66x31 | 66 |     |     |               |          | GSA.LE-     | 4826    | GSB.LE-     | 5481    |
| Gallery Shell: 72x31 | 72 |     |     |               |          | GSA.ME-     | 5073    | GSB.ME-     | 5762    |
| Gallery Shell: 78x31 | 78 |     |     |               |          | GSA.NE-     | 5287    | GSB.NE-     | 6005    |
| Gallery Shell: 84x31 | 84 |     |     |               |          | GSA.OE-     | 5549    | GSB.OE-     | 6305    |
| Gallery Shell: 90x31 | 90 |     |     |               |          | GSA.PE-     | 5762    | GSB.PE-     | 6548    |

|                               |    |     |       |     |      |     |      |  |  |
|-------------------------------|----|-----|-------|-----|------|-----|------|--|--|
| • Gallery End Panel 31d x 42h | +1 |     |       | Z   | 1420 | Z   | 1687 |  |  |
| Modules: -                    |    | 30d | 28.4h |     |      |     |      |  |  |
| End Panel 30                  | 1  |     |       | A   | 980  | A   | 1244 |  |  |
| • 2File 18                    | 18 |     |       | W   | 4365 | W   | 5646 |  |  |
| • 2Box/File 18                | 18 |     |       | Y   | 4585 | Y   | 5873 |  |  |
| • 4Box 18                     | 18 |     |       | 0   | 4809 | 0   | 6085 |  |  |
| • Open Kneespace              |    |     |       | (#) | —    | (#) | —    |  |  |

# = inches required

Gallery Modules 37d

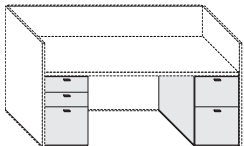
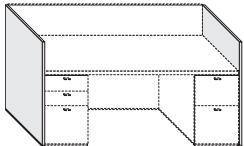
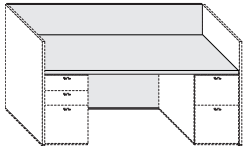

| Gallery Shell        | w  | 37d | 42h | 0.5 Base Trim | 3.5 Base | Product No. | List \$ | Product No. | List \$ |
|----------------------|----|-----|-----|---------------|----------|-------------|---------|-------------|---------|
| Gallery Shell: 72x37 | 72 |     |     |               |          | GSA.MF-     | 5257    | GSB.MF-     | 5970    |
| Gallery Shell: 78x37 | 78 |     |     |               |          | GSA.NF-     | 5483    | GSB.NF-     | 6238    |
| Gallery Shell: 84x37 | 84 |     |     |               |          | GSA.OF-     | 5773    | GSB.OF-     | 6558    |
| Gallery Shell: 90x37 | 90 |     |     |               |          | GSA.PF-     | 5997    | GSB.PF-     | 6815    |

|                             |    |     |       |     |      |     |      |  |  |
|-----------------------------|----|-----|-------|-----|------|-----|------|--|--|
| Gallery End Panel 37d x 42h | +1 |     |       | Z   | 1547 | Z   | 1814 |  |  |
| Modules: -                  |    | 36d | 28.4h |     |      |     |      |  |  |
| End Panel 36                | 1  |     |       | A   | 1107 | A   | 1368 |  |  |
| 2File 18                    | 18 |     |       | W   | 4494 | W   | 5778 |  |  |
| 2Box/File 18                | 18 |     |       | Y   | 4730 | Y   | 6015 |  |  |
| 4Box 18                     | 18 |     |       | 0   | 4964 | 0   | 6248 |  |  |
| Open Kneespace              |    |     |       | (#) | —    | (#) | —    |  |  |

# = inches required

! Notes

To specify, add the appropriate letter codes to the end of the Gallery Shell number above, in L to R order. Item numbers and pricing are shown for cost estimation purposes.

After receiving a customer supplied layout, TUOHY will construct a complete bill of material to include the proper components to create the layout.

Pedestals (28.4h—Locks included where applicable) -:

Gallery Added Elements

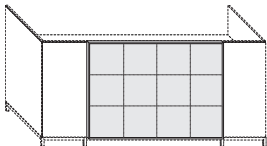
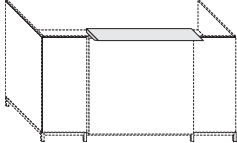
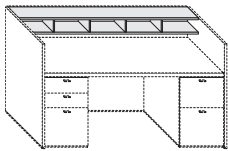
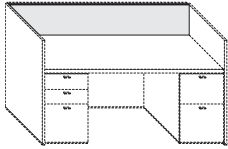
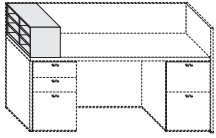

Product No. List \$

| Document Manager      | 11.7w d 12.1h |        |      |
|-----------------------|---------------|--------|------|
| • Document Manager 24 | 24            | GSDM.D | 2658 |
| Document Manager 30   | 30            | GSDM.E | 3079 |
| Document Manager 36   | 36            | GSDM.F | 3292 |

| Fabric Panel      | w  | 1d 12.1h | COM |        |      |
|-------------------|----|----------|-----|--------|------|
| Fabric Panel 24   | 24 |          | 0.7 | GSFP.D | 534  |
| Fabric Panel 30   | 30 |          | 1   | GSFP.E | 579  |
| Fabric Panel 36   | 36 |          | 1.1 | GSFP.F | 622  |
| Fabric Panel 42   | 42 |          | 1.3 | GSFP.G | 753  |
| Fabric Panel 48   | 48 |          | 1.5 | GSFP.H | 882  |
| Fabric Panel 54   | 54 |          | 1.6 | GSFP.J | 1011 |
| Fabric Panel 60   | 60 |          | 1.7 | GSFP.K | 1034 |
| Fabric Panel 66   | 66 |          | 2   | GSFP.L | 1058 |
| • Fabric Panel 72 | 72 |          | 2.1 | GSFP.M | 1078 |
| Fabric Panel 78   | 78 |          | 2.3 | GSFP.N | 1137 |
| Fabric Panel 84   | 84 |          | 2.5 | GSFP.O | 1176 |
| Fabric Panel 90   | 90 |          | 2.7 | GSFP.P | 1235 |

| Cubby Manager      | w  | 11d 6.8h |        |      |
|--------------------|----|----------|--------|------|
| Cubby Manager 48   | 48 |          | GSCM.H | 2883 |
| Cubby Manager 54   | 54 |          | GSCM.J | 2946 |
| Cubby Manager 60   | 60 |          | GSCM.K | 3003 |
| Cubby Manager 66   | 66 |          | GSCM.L | 3066 |
| Cubby Manager 72   | 72 |          | GSCM.M | 3129 |
| • Cubby Manager 78 | 78 |          | GSCM.N | 3173 |
| Cubby Manager 84   | 84 |          | GSCM.O | 3211 |
| Cubby Manager 90   | 90 |          | GSCM.P | 3377 |

| Transaction Top | w  | 12d 1.5th |        |      |
|-----------------|----|-----------|--------|------|
| GalleryTop 36   | 36 |           | GSTT.F | 1896 |
| GalleryTop 42   | 42 |           | GSTT.G | 1958 |
| GalleryTop 48   | 48 |           | GSTT.H | 2020 |
| • GalleryTop 54 | 54 |           | GSTT.J | 2086 |
| GalleryTop 60   | 60 |           | GSTT.K | 2155 |
| GalleryTop 66   | 66 |           | GSTT.L | 2222 |
| GalleryTop 72   | 72 |           | GSTT.M | 2288 |
| GalleryTop 78   | 78 |           | GSTT.N | 2332 |
| GalleryTop 84   | 84 |           | GSTT.O | 2364 |
| GalleryTop 90   | 90 |           | GSTT.P | 2534 |

For Gallery Tops ready for customer-supplied and installed stone, specify Option GT.

| Gallery Front Panel | w  | 1.9d38.5h | Wood1  | Opt LM<br>Silex | Opt SM<br>Stch Silex |
|---------------------|----|-----------|--------|-----------------|----------------------|
| Gallery Front 36    | 36 |           | GSTP.F | 5032            | 7558 7982            |
| Gallery Front 42    | 42 |           | GSTP.G | 5326            | 7849 8273            |
| Gallery Front 48    | 48 |           | GSTP.H | 5597            | 8122 8546            |
| • Gallery Front 54  | 54 |           | GSTP.J | 5855            | 8381 8805            |
| Gallery Front 60    | 60 |           | GSTP.K | 6123            | 8646 9074            |
| Gallery Front 66    | 66 |           | GSTP.L | 6387            | 8911 9336            |
| Gallery Front 72    | 72 |           | GSTP.M | 6654            | 9181 9606            |
| Gallery Front 78    | 78 |           | GSTP.N | 6914            | 9443 9869            |
| Gallery Front 84    | 84 |           | GSTP.O | 7187            | 9715 10139           |
| Gallery Front 90    | 90 |           | GSTP.P | 7449            | 9973 10400           |

For Silex Gallery Front panel, specify Option LM; price is as listed above right.

• For stitched Silex Gallery Front panel, specify Option SM; price is as listed above far right.

For customer materials on the Gallery Front panel, specify Option COM; price is per Customer Service.

Shipping address for COM/COL materials and memo samples:

TUOHY Furniture Corporation, P1 Upholstery Receiving, 42 Saint Albans Place, Chatfield, MN 55923



Specify: Item Number  
Quantity  
Tagging  
Wood Finish

• Denotes Item is illustrated.  
‡ Requires field sub-assembly.

Metal finish is MBN Brushed Nickel.

Prices listed in Wood1 Finishes.

Double Pedestal Desks, AdjHt

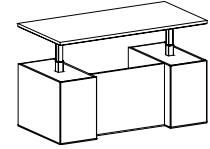
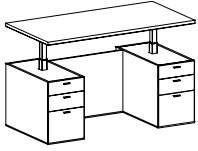

0.5 Base, 29.9-48h

Desk 66w

Desk 72w

Desk 78w

Product No.

List \$

36d

GAD?.LFAH 15813

GAD?.MFAH 16023

GAD?.NFAH 16182

? Specify configuration (user's left-right) by modifying the Product Number:

For 2BF-2BF, change the 4th digit from ? to A

For 2F-2F, change the 4th digit from ? to B

For 2BF-2F, change the 4th digit from ? to C

For 2F-2BF, change the 4th digit from ? to D

Single Pedestal Desks, AdjHt

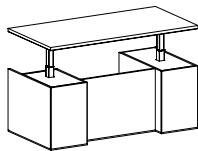
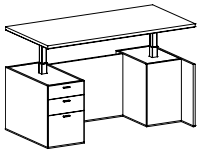

0.5 Base, 29.9-48h

Desk 66w

Desk 72w

Desk 78w

36d

GAD?.LFAH 13057

GAD?.MFAH 13270

GAD?.NFAH 13425

? Specify configuration (user's left-right) by modifying the Product Number:

For P base-2BF, change the 4th digit from ? to E

For P base-2F, change the 4th digit from ? to F

For 2BF-P base, change the 4th digit from ? to G

For 2F-P base, change the 4th digit from ? to H

Inquire with Customer Service about adding lift shrouds and modesty panels that follow the top.

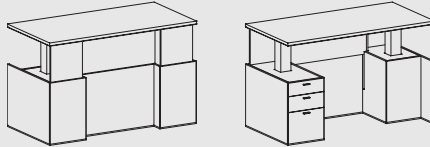

Runoffs/2BF-Modesty, AdjHt

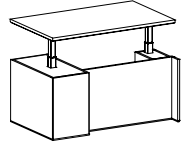
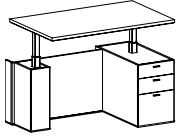

| Product No.        | List \$ | Product No.  | List \$ | Product No.  | List \$ |
|--------------------|---------|--------------|---------|--------------|---------|
| 0.5 Base, 29.9-48h |         | 30d          |         | 36d          |         |
| Runoff LH 42w      |         | GBAL.GEL.AAH | 13413   | GBAL.GFL.BAH | 13668   |
| Runoff LH 48w      |         | GBAL.HEL.AAH | 13668   | GBAL.HFL.BAH | 13935   |
| Runoff LH 54w      |         | GBAL.JEL.AAH | 13897   | GBAL.JFL.BAH | 14179   |
| Runoff LH 60w      |         | GBAL.KEL.AAH | 14113   | GBAL.KFL.BAH | 14369   |
| Runoff RH 42w      |         | GBAL.GER.AAH | 13413   | GBAL.GFR.BAH | 13668   |
| Runoff RH 48w      |         | GBAL.HER.AAH | 13668   | GBAL.HFR.BAH | 13935   |
| Runoff RH 54w      |         | GBAL.JER.AAH | 13897   | GBAL.JFR.BAH | 14179   |
| Runoff RH 60w      |         | GBAL.KER.AAH | 14113   | GBAL.KFR.BAH | 14369   |

Runoffs/2F-Modesty, AdjHt

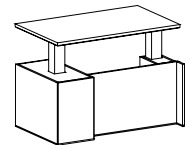
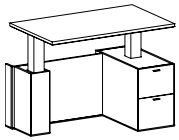

| Product No.        | List \$ | Product No.  | List \$ | Product No.  | List \$ |
|--------------------|---------|--------------|---------|--------------|---------|
| 0.5 Base, 29.9-48h |         | 30d          |         | 36d          |         |
| Runoff LH 42w      |         | GBAL.GEL.CAH | 13216   | GBAL.GFL.DAH | 13458   |
| Runoff LH 48w      |         | GBAL.HEL.CAH | 13470   | GBAL.HFL.DAH | 13728   |
| Runoff LH 54w      |         | GBAL.JEL.CAH | 13701   | GBAL.JFL.DAH | 13970   |
| Runoff LH 60w      |         | GBAL.KEL.CAH | 13917   | GBAL.KFL.DAH | 14160   |
| Runoff RH 42w      |         | GBAL.GER.CAH | 13216   | GBAL.GFR.DAH | 13458   |
| Runoff RH 48w      |         | GBAL.HER.CAH | 13470   | GBAL.HFR.DAH | 13728   |
| Runoff RH 54w      |         | GBAL.JER.CAH | 13701   | GBAL.JFR.DAH | 13970   |
| Runoff RH 60w      |         | GBAL.KER.CAH | 13917   | GBAL.KFR.DAH | 14160   |

Runoffs/Plinth-Modesty, AdjHt

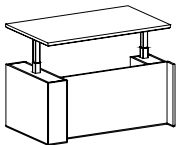
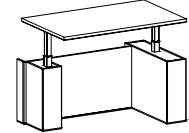

| Product No.        | List \$ | Product No.  | List \$ | Product No.  | List \$ |
|--------------------|---------|--------------|---------|--------------|---------|
| 0.5 Base, 29.9-48h |         | 24d          |         | 30d          |         |
| Runoff LH 42w      |         | GBAL.GEL.EAH | 12726   | GBAL.GEL.FAH | 12970   |
| Runoff LH 48w      |         | GBAL.HEL.EAH | 12973   | GBAL.HEL.FAH | 13226   |
| Runoff LH 54w      |         | GBAL.JEL.EAH | 13190   | GBAL.JEL.FAH | 13456   |
| Runoff LH 60w      |         | GBAL.KEL.EAH | 13349   | GBAL.KEL.FAH | 13670   |
| Runoff RH 42w      |         | GBAL.GER.EAH | 12726   | GBAL.GER.FAH | 12970   |
| Runoff RH 48w      |         | GBAL.HER.EAH | 12973   | GBAL.HER.FAH | 13226   |
| Runoff RH 54w      |         | GBAL.JER.EAH | 13190   | GBAL.JER.FAH | 13456   |
| Runoff RH 60w      |         | GBAL.KER.EAH | 13349   | GBAL.KER.FAH | 13670   |

Bridges/Modesty, AdjHt

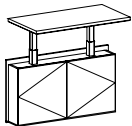

| Product No.            | List \$ | Product No.   | List \$ |
|------------------------|---------|---------------|---------|
| 0.5 Base, 29.9-48h     |         | Finished Back |         |
| Bridge 36w 9d, 24d top |         | GCDM.FAAH     | 10959   |
| Bridge 42w 9d, 24d top |         | GCDM.GAAH     | 11556   |
| Bridge 48w 9d, 24d top |         | GCDM.HAAH     | 12170   |
| Bridge 54w 9d, 24d top |         | GCDM.JAAH     | 12751   |

Tops



|         | Product No. | List \$ | Product No. | List \$ | Product No. | List \$ |
|---------|-------------|---------|-------------|---------|-------------|---------|
| 1.5th   | 24d         |         | 30d         |         | 36d         |         |
| Top 42w | GCAL.F24AH  | 1468    | GCAL.F30AH  | 1601    | GCAL.F36AH  | 1727    |
| Top 48w | GCAL.G24AH  | 1573    | GCAL.G30AH  | 1714    | GCAL.G36AH  | 1853    |
| Top 54w | GCAL.H24AH  | 1671    | GCAL.H30AH  | 1825    | GCAL.H36AH  | 1976    |
| Top 60w | GCAL.J24AH  | 1767    | GCAL.J30AH  | 1976    | GCAL.J36AH  | 2103    |
| Top 72w | GCAL.K24AH  | 2109    | GCAL.K30AH  | 2202    | GCAL.K36AH  | 2284    |
| Top 78w | GCAL.L24AH  | 2206    | GCAL.L30AH  | 2372    | GCAL.L36AH  | 2462    |

Modesty Panels



|                   | Product No.   | List \$ |  |
|-------------------|---------------|---------|--|
| 0.5 Base, 27.4h   | Finished Back |         |  |
| Modesty Panel 24w | GJVF.DAH      | 1232    |  |
| Modesty Panel 30w | GJVF.EAH      | 1373    |  |
| Modesty Panel 36w | GJVF.FAH      | 1495    |  |
| Modesty Panel 42w | GJVF.GAH      | 1557    |  |
| Modesty Panel 48w | GJVF.HAH      | 1635    |  |

File/File

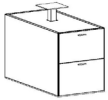

|                 | Product No. | List \$ | Product No. | List \$ |
|-----------------|-------------|---------|-------------|---------|
| 0.5 Base, 27.4h |             |         | 30d         |         |
| File/File 18w   |             |         | GKAF30AH-W  | 5539    |
|                 |             |         | GKAF36AH-W  | 5654    |

Pencil/Box/File



|                     | Product No. | List \$ | Product No. | List \$ |
|---------------------|-------------|---------|-------------|---------|
| 0.5 Base, 27.4h     |             |         | 30d         |         |
| Pencil/Box/File 18w |             |         | GKAF30AH-Y  | 5737    |
|                     |             |         | GKAF36AH-Y  | 5864    |

Plinths



|                   | Product No. | List \$ | Product No. | List \$ | Product No. | List \$ |
|-------------------|-------------|---------|-------------|---------|-------------|---------|
| 0.5 Base, 27.4h   |             |         |             |         |             |         |
| Plinth 9.5w 9.25d | GKAAH9.P    | 4845    |             |         |             |         |
| Plinth 9.5w 14d   | GKAAH14.P   | 4961    |             |         |             |         |
| Plinth 9.5w 18d   | GKAAH18.P   | 5034    |             |         |             |         |
| Plinth 9.5w 24d   | GKAAH24.P   | 5181    |             |         |             |         |
| Plinth 9.5w 30d   | GKAAH30.P   | 5294    |             |         |             |         |
| Plinth 9.5w 36d   | GKAAH36.P   | 5425    |             |         |             |         |

Plinths Extended End



|                         |  | 30d (14d Plinth) |      | 36d (20d Plinth) |      |
|-------------------------|--|------------------|------|------------------|------|
| 0.5 Base, 27.4h         |  |                  |      |                  |      |
| Plinth ExtendEnd 18w LH |  | GKAAH30.PEL      | 6389 | GKAAH36.PEL      | 6591 |
| Plinth ExtendEnd 18w RH |  | GKAAH30.PER      | 6389 | GKAAH36.PER      | 6591 |

Wall Hung Plinths

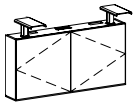

|                         | 0.5 Base, 29.9-48h | Unfinished Back |
|-------------------------|--------------------|-----------------|
| Wall Hung Plinth 54w 9d | GKAWH.54           | 9861            |
| Wall Hung Plinth 60w 9d | GKAWH.60           | 10296           |
| Wall Hung Plinth 66w 9d | GKAWH.66           | 10735           |
| Wall Hung Plinth 72w 9d | GKAWH.72           | 11177           |
| Wall Hung Plinth 78w 9d | GKAWH.78           | 11638           |

! Notes:

- Short plinth must be attached to adjacent credenza for support.
- 2 short plinths cannot be used on one desk.
- All worksurfaces have 1" space to adjacent surfaces for pinch point.
- 48" maximum worksurface height.
- Tops are 1.5" thick.
- Inquire with Customer Service regarding widths over 78".
- Default leg color is Black.
- Each top is designed to accept 30lbs. of added weight for computers and user items.
- Accessory power: Dean Z mount ELDZ321SBLK 3-port (2) Simplex (1) USB A+C, soft plug, black.
- Units come with 120" soft plug power cord.
- Face locks are included as standard on all pedestals except where noted.
- Locks not available on Bridge and wall hung units.
- Height adjustable units are not available with Silex top inserts or Silex wrapped height adj modesty panels.
- For Silex drawer faces, specify Option LF; add \$960 per drawer.
- For Stitched Silex drawer faces, specify Option SF; add \$1306 per drawer.
- For Silex modesty panel (fixed modesty only), specify Option LM; add \$2468.
- For Stitched Silex modesty panel (fixed modesty only), specify Option SM; add \$2880.
- All units have finished backs unless otherwise noted.
- Tops are not included on Wall Hung units.
- Tops are maximum depth of 24" on Bridge and Wall Hung units.

+ Options:

- For shrouds over legs specify Option SH; add \$840.
- For shrouds and modesty specify Option SHM; add \$840 PLUS cost of modesty from above.
- Inquire with Customer Service regarding alternate leg color options (White or Silver).

Desks/Double Pedestal, AdjHt



|                    | Product No. | List \$ |
|--------------------|-------------|---------|
| 3.5 Base, 29.9-48h | 36d         |         |
| Desk 66w           | GAAA.LFAH   | 18477   |
| Desk 72w           | GAAA.MFAH   | 18663   |
| Desk 78w           | GAAA.NFAH   | 18814   |

Desks/Single Pedestal, AdjHt



|                    | Product No. | List \$ |
|--------------------|-------------|---------|
| 3.5 Base, 29.9-48h | 36d         |         |
| Desk 66w           | GAA?.LFAH   | 14971   |
| Desk 72w           | GAA?.MFAH   | 15164   |
| Desk 78w           | GAA?.NFAH   | 15318   |

? Specify configuration (user's left-right) by modifying the Product Number:  
 For P base-2BF, change the 4th digit from ? to E  
 For 2BF-P base, change the 4th digit from ? to G

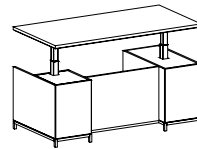

Inquire with Customer Service about adding lift shrouds and modesty panels that follow the top.

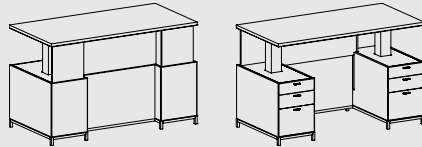

Runoffs/2BF-Modesty, AdjHt

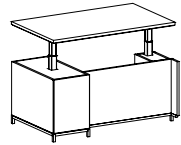

| Product No.        | List \$ | Product No.  | List \$ | Product No.  | List \$ |
|--------------------|---------|--------------|---------|--------------|---------|
| 3.5 Base, 29.9-48h |         | 30d          |         | 36d          |         |
| Runoff LH 42w      |         | GBAL.GEL.GAH | 15059   | GBAL.GFL.HAH | 15311   |
| Runoff LH 48w      |         | GBAL.HEL.GAH | 15323   | GBAL.HFL.HAH | 15589   |
| Runoff LH 54w      |         | GBAL.JEL.GAH | 15547   | GBAL.JFL.HAH | 15828   |
| Runoff LH 60w      |         | GBAL.KEL.GAH | 15762   | GBAL.KFL.HAH | 16013   |
| Runoff RH 42w      |         | GBAL.GER.GAH | 15059   | GBAL.GFR.HAH | 15311   |
| Runoff RH 48w      |         | GBAL.HER.GAH | 15323   | GBAL.HFR.HAH | 15589   |
| Runoff RH 54w      |         | GBAL.JER.GAH | 15547   | GBAL.JFR.HAH | 15828   |
| Runoff RH 60w      |         | GBAL.KER.GAH | 15762   | GBAL.KFR.HAH | 16013   |

Runoffs/Plinth-Modesty, AdjHt

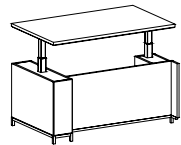

| Product No.        | List \$ | Product No.  | List \$ | Product No.  | List \$ |
|--------------------|---------|--------------|---------|--------------|---------|
| 3.5 Base, 29.9-48h |         | 24d          |         | 30d          |         |
| Runoff LH 42w      |         | GBAL.GEL.LAH | 13958   | GBAL.GEL.MAH | 14201   |
| Runoff LH 48w      |         | GBAL.HEL.LAH | 14213   | GBAL.HEL.MAH | 14463   |
| Runoff LH 54w      |         | GBAL.JEL.LAH | 14422   | GBAL.JEL.MAH | 14688   |
| Runoff LH 60w      |         | GBAL.KEL.LAH | 14578   | GBAL.KEL.MAH | 14901   |
| Runoff RH 42w      |         | GBAL.GER.LAH | 13958   | GBAL.GER.MAH | 14201   |
| Runoff RH 48w      |         | GBAL.HER.LAH | 14213   | GBAL.HER.MAH | 14463   |
| Runoff RH 54w      |         | GBAL.JER.LAH | 14422   | GBAL.JER.MAH | 14688   |
| Runoff RH 60w      |         | GBAL.KER.LAH | 14578   | GBAL.KER.MAH | 14901   |

Bridges/Modesty, AdjHt

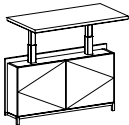

| Product No.            | List \$ | Product No.   | List \$ |
|------------------------|---------|---------------|---------|
| 3.5 Base, 29.9-48h     |         | Finished Back |         |
| Bridge 36w 9d, 24d top |         | GCDM.FBAH     | 11488   |
| Bridge 42w 9d, 24d top |         | GCDM.GBAH     | 12083   |
| Bridge 48w 9d, 24d top |         | GCDM.HBAH     | 13537   |
| Bridge 54w 9d, 24d top |         | GCDM.JBAH     | 13280   |

Tops



|         | Product No. | List \$ | Product No. | List \$ | Product No. | List \$ |
|---------|-------------|---------|-------------|---------|-------------|---------|
| 1.5th   | 24 d        |         | 30d         |         | 36d         |         |
| Top 42w | GCAL.F24AH  | 1468    | GCAL.F30AH  | 1601    | GCAL.F36AH  | 1727    |
| Top 48w | GCAL.G24AH  | 1573    | GCAL.G30AH  | 1714    | GCAL.G36AH  | 1853    |
| Top 54w | GCAL.H24AH  | 1671    | GCAL.H30AH  | 1825    | GCAL.H36AH  | 1976    |
| Top 60w | GCAL.J24AH  | 1767    | GCAL.J30AH  | 1976    | GCAL.J36AH  | 2103    |
| Top 72w | GCAL.K24AH  | 2109    | GCAL.K30AH  | 2202    | GCAL.K36AH  | 2284    |
| Top 78w | GCAL.L24AH  | 2206    | GCAL.L30AH  | 2372    | GCAL.L36AH  | 2462    |

Modesty Panels



|                   | Product No.   | List \$ |  |
|-------------------|---------------|---------|--|
| 3.5 Base, 27.4h   | Finished Back |         |  |
| Modesty Panel 24w | GJUF.DAH      | 1406    |  |
| Modesty Panel 30w | GJUF.EAH      | 1557    |  |
| Modesty Panel 36w | GJUF.FAH      | 1671    |  |
| Modesty Panel 42w | GJUF.GAH      | 1728    |  |
| Modesty Panel 48w | GJUF.HAH      | 1811    |  |

Pencil/Box/File



|                     | Product No. | List \$ | Product No. | List \$ |
|---------------------|-------------|---------|-------------|---------|
| 3.5 Base, 27.4h     |             |         | 30d         |         |
| Pencil/Box/File 18w |             |         | GKBF30AH-Y  | 6681    |
|                     |             |         | 36d         |         |
|                     |             |         | GKBF36AH-Y  | 6807    |

Plinth



|                   | Product No. | List \$ | Product No. | List \$ | Product No. | List \$ |
|-------------------|-------------|---------|-------------|---------|-------------|---------|
| 3.5 Base, 27.4h   |             |         |             |         |             |         |
| Plinth 9.5w 9.25d | GKBAH9.P    | 5373    |             |         |             |         |
| Plinth 9.5w 14d   | GKBAH14.P   | 5493    |             |         |             |         |
| Plinth 9.5w 18d   | GKBAH18.P   | 5563    |             |         |             |         |
| Plinth 9.5w 24d   | GKBAH24.P   | 5710    |             |         |             |         |
| Plinth 9.5w 30d   | GKBAH30.P   | 5821    |             |         |             |         |
| Plinth 9.5w 36d   | GKBAH36.P   | 5954    |             |         |             |         |

Plinths Extended End



| 3.5 Base, 27.4h         | 30d (14d Plinth) |      | 36d (20d Plinth) |      |
|-------------------------|------------------|------|------------------|------|
| Plinth ExtendEnd LH 18w | GKBAH30.PEL      | 6753 | GKBAH36.PEL      | 6937 |
| Plinth ExtendEnd RH 18w | GKBAH30.PER      | 6753 | GKBAH36.PER      | 6937 |

Wall Hung Plinths, AdjHt

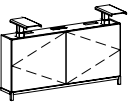

| 3.5 Base, 29.9-48h      | Unfinished Back |       |  |
|-------------------------|-----------------|-------|--|
| Wall Hung Plinth 54w 9d | GKBWH.54        | 10390 |  |
| Wall Hung Plinth 60w 9d | GKBWH.60        | 10826 |  |
| Wall Hung Plinth 66w 9d | GKBWH.66        | 11386 |  |
| Wall Hung Plinth 72w 9d | GKBWH.72        | 11964 |  |
| Wall Hung Plinth 78w 9d | GKBWH.78        | 12670 |  |

! Notes:

- Short plinth must be attached to adjacent credenza for support.
- 2 short plinths cannot be used on one desk.
- All worksurfaces have 1" space to adjacent surfaces for pinch point.
- 48" maximum worksurface height.
- Tops are 1.5" thick.
- Inquire with Customer Service regarding widths over 78".
- Default leg color is Black.
- Each top is designed to accept 30lbs. of added weight for computers and user items.
- Accessory power: Dean Z mount ELDZ321SBLK 3-port (2) Simplex (1) USB A+C, soft plug, black.
- Units come with 120" soft plug power cord.
- Face locks are included as standard on all pedestals except where noted.
- Locks not available on Bridge and wall hung units.
- Height adjustable units are not available with Silex top inserts or Silex wrapped height adj modesty panels.
- For Silex drawer faces, specify Option LF; add \$ 960 per drawer.
- For Stitched Silex drawer faces, specify Option SF; add \$1306 per drawer.
- For Silex modesty panel (fixed modesty only), specify Option LM; add \$2468.
- For Stitched Silex modesty panel (fixed modesty only), specify Option SM; add \$2880.
- All units have finished backs unless otherwise noted.
- Tops are not included on Wall Hung units.
- Tops are maximum depth of 24" on Bridge and Wall Hung units.

+ Options:

- For shrouds over legs specify Option SH; add \$ 840.
- For shrouds and modesty specify Option SHM; add \$840 PLUS cost of modesty from above.
- Inquire with Customer Service regarding alternate leg color options (White or Silver).

