

TUOHY

Prima

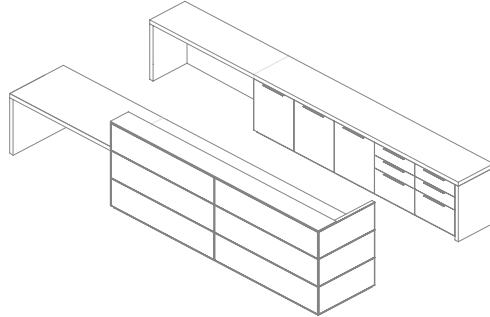

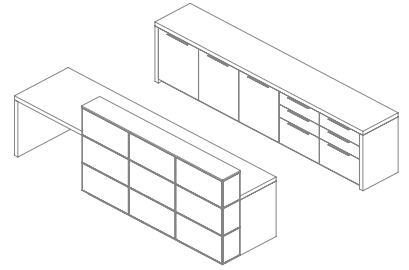
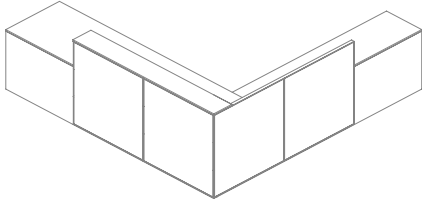

Design: John Nelson

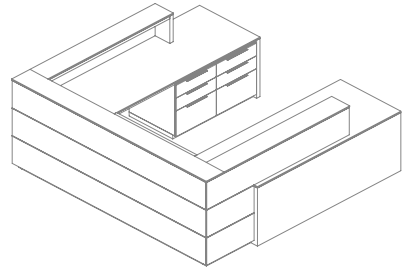

Reception: *Prima*

- | | |
|-----------------------------------|------|
| Desks, 0.5th Top | BP6 |
| Bridges, 0.5th Top | BP7 |
| Runoffs, 0.5th Top | BP7 |
| Desks, 2th Top | BP8 |
| Credenzas, 2th Top | BP8 |
| Bridges, 2th Top | BP8 |
| Runoffs, 2th Top | BP9 |
| Pedestals | BP10 |
| Support Keels | BP11 |
| Gallery Tops, 10.8d 0.5th* | BP12 |
| Gallery Backsplashes, 12.2h 1.5th | BP12 |
| Gallery Backsplash Magnet | BP13 |
| Gallery & Surround Tackboards | BP13 |
| Gallery Surround Panels | BP14 |
| - Wood1 | BP14 |
| - Polished Acrylic Solid Surface | BP16 |
| - 3Form® Reflect | BP18 |
| - Carrara Marble | BP20 |
| - Satin Brushed Nickel | BP22 |
| - Silex Faux Leather | BP24 |
| - Back-Painted Glass | BP26 |
| - Stainless Steel Wire Mesh | BP28 |
| - Gilded Cork | BP30 |

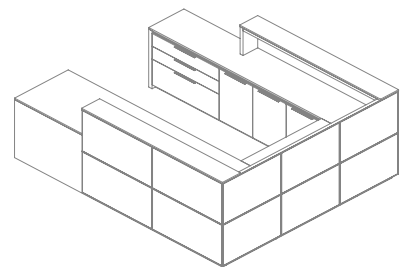
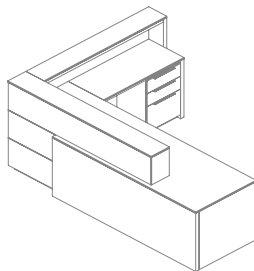
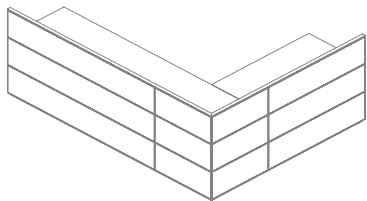
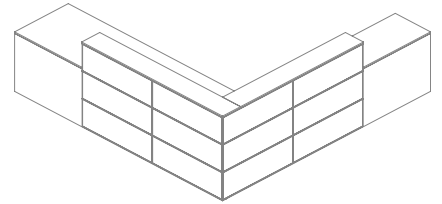
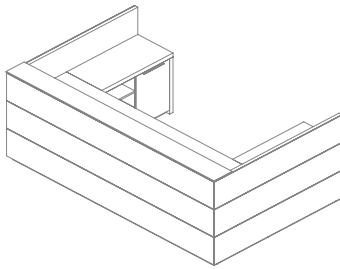

Drawer Layouts: Plan View

Slides: Side-Mount

Pedestal Units 18d
Drawers 16d

16w 20w 24w 28w 32w 36w

Box Drawers w Divider

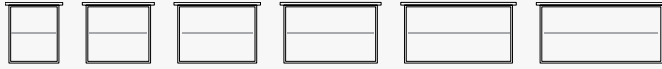

File Drawers: Lateral

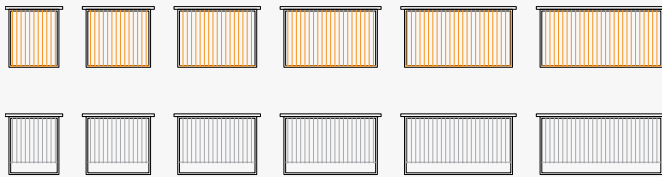

File Drawers: Front-to-Back



Pedestal Units 28d
Drawers 20.1d

16w 20w 24w 28w 32w 36w

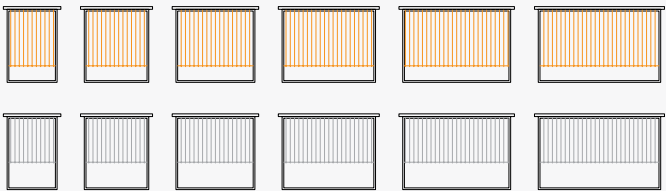

DRAWER CONSTRUCTION

A fine point for a quality casegood product is the inner drawer construction. Each TUOHY casegood offers you uncompromised excellence in this area as well. Drawer boxes are constructed with dovetail joinery for maximum durability. The drawer face is mounted separately to this box (i.e., five-sided construction) to maintain integrity.

Drawer bottoms are dadoed on all four sides. Slides for box drawers are rated at 100 pounds per drawer; slides for file drawers are rated at a heavy duty 150 pound load per drawer. All slides have progressive action.

Box drawers have a removable divider, adjustable when depicted (+). File drawers have file frames for filing laterally or front-to-back, as depicted. For Drawers for Lap Area, Drawer Pencil Tray, and Locks: See the Introduction/Terms-Options section of the Master Price List, page 12.

Specify: Product Number
Quantity
Color/Finish
Tagging

‡ Requires field sub-assembly.

— Legal Filing
— Letter Filing
+ Adjustable Divider

Desks, Credenzas, Bridges & Runoffs
See pages BP6 to BP10

Pedestals
See page BP11

Prima Collection is a highly flexible system of furniture components that combine to create an extensive, elegant and creative series of reception and administrative assistant workstations.

Simply configure desk, runoff, bridge and credenza shells to form in-line, L-shaped and U-shaped layouts. Add pedestals and situate galleries and/or surround panels as needed.

You have considerable flexibility in the scale and placement of these elements. Surround panels and gallery fronts may be defined in whatever segmented matrix and material you desire.

In addition to what is presented here, Prima has been designed to accept a nearly limitless range of customers' architectural and interior materials and finishes. Use Prima for maximum impact in reception areas, but with considerably less rigor and expense than custom millwork solutions.



0.5-inch Top, Closed Shell
0.5-inch Top, Closed Shell for Recessed Galleries
2-inch Top, Open Shell



Choose from the following in a range of widths and materials/finishes, and arrange in modular sequence:

- Shelving
- Cabinets
- Box and File Storage Drawers
- Trash/Recycle Drawers
- Utility Drawers

Add power/data accessories as needed.

Surround Panels and Galleries

See pages BP12 to BP37

Width & Placement Relative to Shell



Function and form are achieved by your relative placement of surround panels and galleries on the casegood shells, whether centered, shifted left or shifted right by any dimension you desire.

Surround Panels are 2 inches thick, modular, and specified in left-to-right approach sequence at widths from 21 inches to 124 inches. Each surround panel is one segment wide by up to three segments tall (see 1x1, 1x2 and 1x3 at right). Surround panels may abut galleries.

Galleries are single mass, 10.8 inches deep, specified according to the desired matrix layout as shown at right. Galleries receive a transaction top and backsplash or tackable surface, all of which are specified separately.

All panels and galleries have a mitered/quirk detail at corners to perpendicular runs.

Matrix Layouts



Specify: Finish / Color / Material / Tagging / Assembly

Matrix Face Material / Matrix Edge / (user-side)

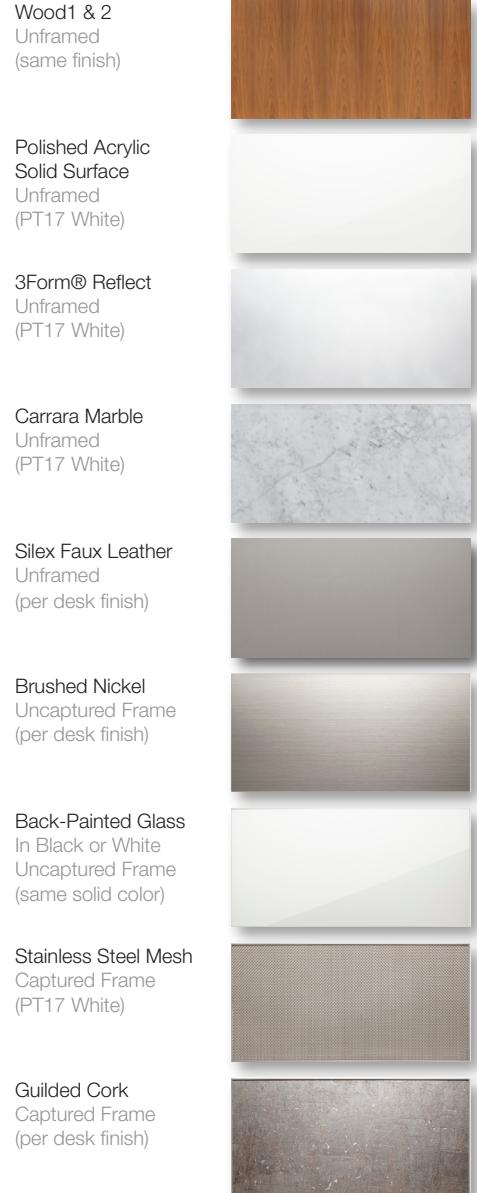

Desks, 0.5th Top

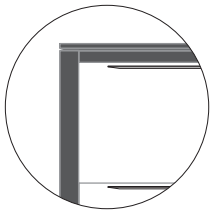

32d Wood1 Closed Shell	w	Wood1 Top	\$	Solid Surface Top	\$
Desk/0.5Top 76w 32d 29.5h	76	PZDWC76	5219	PZDWCC76	6729
Desk/0.5Top 84w 32d 29.5h	84	PZDWC84	5493	PZDWCC84	7159
Desk/0.5Top 92w 32d 29.5h	92	PZDWC92	5709	PZDWCC92	7534
Desk/0.5Top 100w 32d 29.5h	100	PZDWC100	5928	PZDWCC100	7914
Desk/0.5Top 108w 32d 29.5h	108	PZDWC108	6148	PZDWCC108	8290
Desk/0.5Top 116w 32d 29.5h	116	PZDWC116	6365	PZDWCC116	8667
Desk/0.5Top 124w 32d 29.5h	124	PZDWC124	6584	PZDWCC124	9045

36d Wood1 Shell for Recessed Gallery	w	Wood1 Top	\$	Solid Surface Top	\$
Desk/0.5Top-RecGal 76w 36d 29.5h LH	76	PZDRWC76L	5441	PZDRWCC76L	7205
Desk/0.5Top-RecGal 76w 36d 29.5h RH	76	PZDRWC76R	5441	PZDRWCC76R	7205
Desk/0.5Top-RecGal 84w 36d 29.5h LH	84	PZDRWC84L	5794	PZDRWCC84L	7313
Desk/0.5Top-RecGal 84w 36d 29.5h RH	84	PZDRWC84R	5794	PZDRWCC84R	7313
Desk/0.5Top-RecGal 92w 36d 29.5h LH	92	PZDRWC92L	6026	PZDRWCC92L	8082
Desk/0.5Top-RecGal 92w 36d 29.5h RH	92	PZDRWC92R	6026	PZDRWCC92R	8082
Desk/0.5Top-RecGal 100w 36d 29.5h LH	100	PZDRWC100L	6259	PZDRWCC100L	8493
Desk/0.5Top-RecGal 100w 36d 29.5h RH	100	PZDRWC100R	6259	PZDRWCC100R	8493
Desk/0.5Top-RecGal 108w 36d 29.5h LH	108	PZDRWC108L	6492	PZDRWCC108L	8904
Desk/0.5Top-RecGal 108w 36d 29.5h RH	108	PZDRWC108R	6492	PZDRWCC108R	8904
Desk/0.5Top-RecGal 116w 36d 29.5h LH	116	PZDRWC116L	6729	PZDRWCC116L	9317
Desk/0.5Top-RecGal 116w 36d 29.5h RH	116	PZDRWC116R	6729	PZDRWCC116R	9317
Desk/0.5Top-RecGal 124w 36d 29.5h LH	124	PZDRWC124L	6962	PZDRWCC124L	9728
Desk/0.5Top-RecGal 124w 36d 29.5h RH	124	PZDRWC124R	6962	PZDRWCC124R	9728

! Notes:

Specify wood species/color from TUOHY Wood1 offerings; inquire about upcharges for Wood2 finishes or custom finishes. Solid Surface is Avonite® 8016 White, Matte.

+ Options/Parametrics:

Width range: 68-124; specify by replacing the last digits of the product number and use next larger standard size for pricing.

Credenzas, 0.5th Top

21d Wood1 Closed Shell	w	Wood1 Top	\$	Solid Surface Top	\$	Option FB
Credenza 76w 21d 29.5h	76	PZCSWC76	4529	PZCSWCC76	5517	+995
Credenza 84w 21d 29.5h	84	PZCSWC84	4670	PZCSWCC84	5762	+1101
Credenza 92w 21d 29.5h	92	PZCSWC92	4811	PZCSWCC92	6009	+1208
Credenza 100w 21d 29.5h	100	PZCSWC100	4953	PZCSWCC100	6254	+1313
Credenza 108w 21d 29.5h	108	PZCSWC108	5094	PZCSWCC108	6497	+1416
Credenza 116w 21d 29.5h	116	PZCSWC116	5233	PZCSWCC116	6743	+1524
Credenza 124w 21d 29.5h	124	PZCSWC124	5375	PZCSWCC124	6988	+1625

! Notes:

Specify wood species/color from TUOHY Wood1 offerings; inquire about upcharges for Wood2 finishes or custom finishes. Solid Surface is Avonite® 8016 White, Matte.

+ Options/Parametrics:

Width range: 60-124; specify by replacing the last digits of the product number and use next larger standard size for pricing. For Finished Back, specify Option FB; add the amount as shown in the far right column.

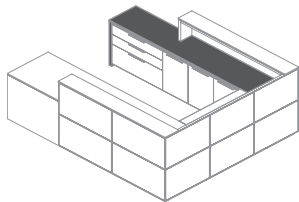

Specify: Product Number
Quantity
Color/Finish
Tagging

‡ Requires field sub-assembly.

	21d Wood1 Closed Shell	w	Wood1 Top	\$	Solid Surface Top	\$
Bridges, 0.5th Top	Bridge/0.5Top 40w 21d 29.5h	40	PZBWC40	1542	PZBWCC40	2064
	Bridge/0.5Top 48w 21d 29.5h	48	PZBWC48	1617	PZBWCC48	2244

! Notes:

Specify wood species/color from TUOHY Wood1 offerings; inquire about upcharges for Wood2 finishes or custom finishes.
Solid Surface is Avonite® 8016 White, Matte.

+ Options/Parametrics:

Width range: 36-48; specify by modifying the last two digits of the product number and use next larger standard size for pricing.

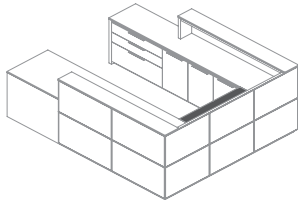

Runoffs, 0.5th Top

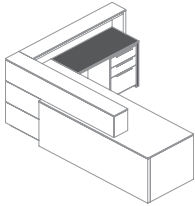

	21d Wood1 Closed Shell	w	Wood1 Top	\$	Solid Surface Top	\$
	Runoff/0.5Top 40w 21d 29.5h LH	40	PZRSWC40L	3161	PZRSWCC40L	3681
	Runoff/0.5Top 40w 21d 29.5h RH	40	PZRSWC40R	3161	PZRSWCC40R	3681
	Runoff/0.5Top 48w 21d 29.5h LH	48	PZRSWC48L	3342	PZRSWCC48L	3940
	Runoff/0.5Top 48w 21d 29.5h RH	48	PZRSWC48R	3342	PZRSWCC48R	3940
	Runoff/0.5Top 56w 21d 29.5h LH	56	PZRSWC56L	3522	PZRSWCC56L	4198
	Runoff/0.5Top 56w 21d 29.5h RH	56	PZRSWC56R	3522	PZRSWCC56R	4198
	Runoff/0.5Top 64w 21d 29.5h LH	64	PZRSWC64L	3701	PZRSWCC64L	4454
	Runoff/0.5Top 64w 21d 29.5h RH	64	PZRSWC64R	3701	PZRSWCC64R	4454
	Runoff/0.5Top 72w 21d 29.5h LH	72	PZRSWC72L	3881	PZRSWCC72L	4715
	Runoff/0.5Top 72w 21d 29.5h RH	72	PZRSWC72R	3881	PZRSWCC72R	4715
	Runoff/0.5Top 80w 21d 29.5h LH	80	PZRSWC80L	4058	PZRSWCC80L	4970
	Runoff/0.5Top 80w 21d 29.5h RH	80	PZRSWC80R	4058	PZRSWCC80R	4970
	Runoff/0.5Top 88w 21d 29.5h LH	88	PZRSWC88L	4240	PZRSWCC88L	5230
	Runoff/0.5Top 88w 21d 29.5h RH	88	PZRSWC88R	4240	PZRSWCC88R	5230
	Runoff/0.5Top 96w 21d 29.5h LH	96	PZRSWC96L	4417	PZRSWCC96L	5485
	Runoff/0.5Top 96w 21d 29.5h RH	96	PZRSWC96R	4417	PZRSWCC96R	5485

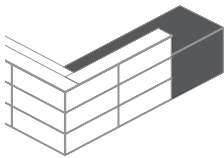

	32d Wood1 Closed Shell	w	Wood1 Top	\$	Solid Surface Top	\$
	Runoff/0.5Top 40w 32d 29.5h LH	40	PZRRWC40L	3434	PZRRWCC40L	4227
	Runoff/0.5Top 40w 32d 29.5h RH	40	PZRRWC40R	3434	PZRRWCC40R	4227
	Runoff/0.5Top 48w 32d 29.5h LH	48	PZRRWC48L	3640	PZRRWCC48L	4564
	Runoff/0.5Top 48w 32d 29.5h RH	48	PZRRWC48R	3640	PZRRWCC48R	4564
	Runoff/0.5Top 56w 32d 29.5h LH	56	PZRRWC56L	3845	PZRRWCC56L	4902
	Runoff/0.5Top 56w 32d 29.5h RH	56	PZRRWC56R	3845	PZRRWCC56R	4902
	Runoff/0.5Top 64w 32d 29.5h LH	64	PZRRWC64L	4049	PZRRWCC64L	5242
	Runoff/0.5Top 64w 32d 29.5h RH	64	PZRRWC64R	4049	PZRRWCC64R	5242
	Runoff/0.5Top 72w 32d 29.5h LH	72	PZRRWC72L	4257	PZRRWCC72L	5581
	Runoff/0.5Top 72w 32d 29.5h RH	72	PZRRWC72R	4257	PZRRWCC72R	5581
	Runoff/0.5Top 80w 32d 29.5h LH	80	PZRRWC80L	4460	PZRRWCC80L	5919
	Runoff/0.5Top 80w 32d 29.5h RH	80	PZRRWC80R	4460	PZRRWCC80R	5919
	Runoff/0.5Top 88w 32d 29.5h LH	88	PZRRWC88L	4668	PZRRWCC88L	6257
	Runoff/0.5Top 88w 32d 29.5h RH	88	PZRRWC88R	4668	PZRRWCC88R	6257
	Runoff/0.5Top 96w 32d 29.5h LH	96	PZRRWC96L	4872	PZRRWCC96L	6595
	Runoff/0.5Top 96w 32d 29.5h RH	96	PZRRWC96R	4872	PZRRWCC96R	6595

! Notes:

Specify wood species/color from TUOHY Wood1 offerings; inquire about upcharges for Wood2 finishes or custom finishes.
Handedness is user's side attachment to Desk.
Solid Surface is Avonite® 8016 White, Matte.

+ Options/Parametrics:

Width range: 36-96; specify by replacing the last digits of the product number and use next larger standard size for pricing.

Specify: Product Number
Quantity
Color/Finish
Tagging

‡ Requires field sub-assembly.

Desks, 2th Top



32d Wood1	w	Open Shell	\$
Desk/2Top 76w 32d 29.5h	76	PZDW76	4692
Desk/2Top 84w 32d 29.5h	84	PZDW84	4900
Desk/2Top 92w 32d 29.5h	92	PZDW92	5103
Desk/2Top 100w 32d 29.5h	100	PZDW100	5309
Desk/2Top 108w 32d 29.5h	108	PZDW108	5515
Desk/2Top 116w 32d 29.5h	116	PZDW116	5718
Desk/2Top 124w 32d 29.5h	124	PZDW124	5926

! Notes:

Specify wood species/color from TUOHY Wood1 offerings; inquire about upcharges for Wood2 finishes or custom finishes. Maximum open span under desk tops is 56-in; use pedestals and Support Keels as needed.

+ Options/Parametrics:

Width range: 68-124; specify by replacing the last digits of the product number and use next larger standard size for pricing.

Credenzas, 2th Top

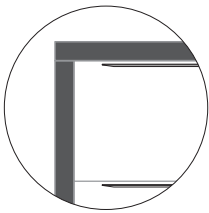

21d Wood1	w	Closed Shell	\$	Option FB
Credenza/2Top 76w 21d 29.5h	76	PZCSW76	4746	+162
Credenza/2Top 84w 21d 29.5h	84	PZCSW84	4940	+180
Credenza/2Top 92w 21d 29.5h	92	PZCSW92	5137	+194
Credenza/2Top 100w 21d 29.5h	100	PZCSW100	5333	+212
Credenza/2Top 108w 21d 29.5h	108	PZCSW108	5531	+230
Credenza/2Top 116w 21d 29.5h	116	PZCSW116	5726	+247
Credenza/2Top 124w 21d 29.5h	124	PZCSW124	5921	+264

! Notes:

Specify wood species/color from TUOHY Wood1 offerings; inquire about upcharges for Wood2 finishes or custom finishes. Maximum open span under Credenza Tops is 56-in; use pedestals and Support Keels as needed.

+ Options/Parametrics:

Width range: 60-124; specify by replacing the last digits of the product number and use next larger standard size for pricing.

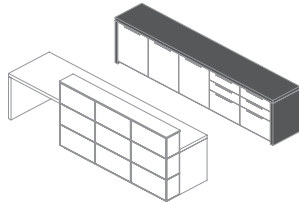

Bridges, 2th Top

21d Wood1	w	Open Shell	\$	Closed Shell	\$
Bridge/2Top 40w 21d 29.5h	40	PZBW40	1280	PZBWB40	2597
Bridge/2Top 48w 21d 29.5h	48	PZBW48	1347	PZBWB48	2769

! Notes:

Specify wood species/color from TUOHY Wood1 offerings; inquire about upcharges for Wood2 finishes or custom finishes.

+ Options/Parametrics:

Width range: 36-48; specify by modifying the last two digits of the product number and use next larger standard size for pricing.

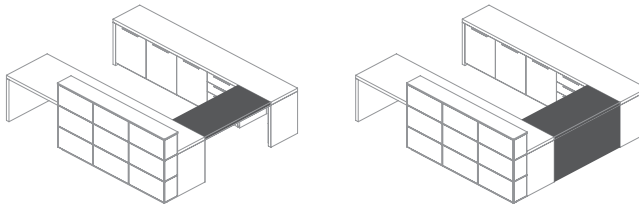

Specify: Product Number
Quantity
Color/Finish
Tagging

‡ Requires field sub-assembly.

Runoffs, 2th Top	21d Wood1	w	Open Shell	\$	Closed Shell LH	\$	Closed Shell RH	\$
	Runoff Shell 40w 21d 29.5h	40	PZRSW40	2394	PZRSWB40L	2932	PZRSWB40R	2932
	Runoff Shell 48w 21d 29.5h	48	PZRSW48	2474	PZRSWB48L	3115	PZRSWB48R	3115
	Runoff Shell 56w 21d 29.5h	56	PZRSW56	2554	PZRSWB56L	3298	PZRSWB56R	3298
	Runoff Shell 64w 21d 29.5h	64	PZRSW64	2630	PZRSWB64L	3486	PZRSWB64R	3486
	Runoff Shell 72w 21d 29.5h	72	PZRSW72	2710	PZRSWB72L	3772	PZRSWB72R	3772
	Runoff Shell 80w 21d 29.5h	80	PZRSW80	2787	PZRSWB80L	3850	PZRSWB80R	3850
	Runoff Shell 88w 21d 29.5h	88	PZRSW88	2868	PZRSWB88L	4032	PZRSWB88R	4032
	Runoff Shell 96w 21d 29.5h	96	PZRSW96	2946	PZRSWB96L	4217	PZRSWB96R	4217
	32d Wood1	w	Open Shell	\$	Closed Shell LH	\$	Closed Shell RH	\$
	Runoff Shell 40w 32d 29.5h	40	PZRRW40	2746	PZRRWB40L	3140	PZRRWB40R	3140
	Runoff Shell 48w 32d 29.5h	48	PZRRW48	2864	PZRRWB48L	3363	PZRRWB48R	3363
	Runoff Shell 56w 32d 29.5h	56	PZRRW56	2988	PZRRWB56L	3589	PZRRWB56R	3589
	Runoff Shell 64w 32d 29.5h	64	PZRRW64	3105	PZRRWB64L	3814	PZRRWB64R	3814
	Runoff Shell 72w 32d 29.5h	72	PZRRW72	3224	PZRRWB72L	4143	PZRRWB72R	4143
	Runoff Shell 80w 32d 29.5h	80	PZRRW80	3344	PZRRWB80L	4259	PZRRWB80R	4259
	Runoff Shell 88w 32d 29.5h	88	PZRRW88	3464	PZRRWB88L	4489	PZRRWB88R	4489
	Runoff Shell 96w 32d 29.5h	96	PZRRW96	3585	PZRRWB96L	4713	PZRRWB96R	4713

! Notes:

Specify wood species/color from TUOHY Wood1 offerings; inquire about upcharges for Wood2 finishes or custom finishes.
 Maximum open span under runoff tops is 56-in; use pedestals and Support Keels as needed.

+ Options/Parametrics:

Width range: 36-96; specify by replacing the last digits of the product number and use next larger standard size for pricing.

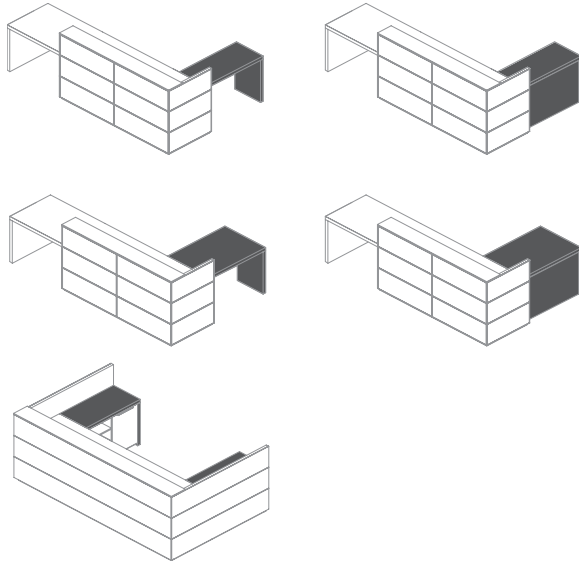

Specify: Product Number
 Quantity
 Color/Finish
 Tagging

‡ Requires field sub-assembly.

Pedestals	Wood1, Unfinished Back and Sides (shell required)	18d		28d	
	Pedestals	PZPED18	\$ sum	PZPED28	\$ sum
		Spec Code	▲	Spec Code	▲
	Open Shelving 16w	F16	1946	F16	2160
	Open Shelving 20w	F20	2059	F20	2314
	Open Shelving 24w	F24	2172	F24	2466
	Open Shelving 28w	F28	2284	F28	2618
	Open Shelving 32w	F32	2398	F32	2772
	Open Shelving 36w	F36	2510	F36	2922
	Cabinet w/Shelf 16w LH	GL16	3095	GL16	3308
	Cabinet w/Shelf 16w RH	GR16	3095	GR16	3308
	Cabinet w/Shelf 20w LH	GL20	3255	GL20	3506
	Cabinet w/Shelf 20w RH	GR20	3255	GR20	3506
	Cabinet w/Shelf 24w LH	GL24	3411	GL24	3704
	Cabinet w/Shelf 24w RH	GR24	3411	GR24	3704
	Cabinet w/Shelf 28w DBL	GD28	3628	GD28	3962
	Cabinet w/Shelf 32w DBL	GD32	3784	GD32	4160
	Cabinet w/Shelf 36w DBL	GD36	3944	GD36	4358
		4Box 16w	M16	4278	M16
4Box 20w		M20	4393	M20	4536
4Box 24w		M24	4573	M24	4737
4Box 28w		M28	4753	M28	4934
4Box 32w		M32	4869	M32	5068
4Box 36w		M36	5031	M36	5248
	2Box/File 16w	L16	3249	L16	3369
	2Box/File 20w	L20	3358	L20	3498
	2Box/File 24w	L24	3521	L24	3674
	2Box/File 28w	L28	3701	L28	3875
	2Box/File 32w	L32	3814	L32	4003
	2Box/File 36w	L36	3962	L36	4167
	2File 16w	K16	3153	K16	3269
	2File 20w	K20	3260	K20	3389
	2File 24w	K24	3401	K24	3547
	2File 28w	K28	3585	K28	3751
	2File 32w	K32	3694	K32	3868
	2File 36w	K36	3822	K36	4041
	Utility Drawer 20w	W20	3225	W20	3563
	Utility Drawer 24w	W24	3375	W24	3807
	TrashRecycle 20w: Dwr/Bin(18d) Dwr/2Bins(28d)	Y20	3150	Y20	3315
	TrashRecycle 24w: Dwr/2Bins(18d) 4Bins(28d)	Y24	3312	Y24	4340
	Removable KneePanel 16w	R16	835	R16	835
	Removable KneePanel 20w	R20	862	R20	862
	Removable KneePanel 24w	R24	895	R24	895
	Removable KneePanel 28w	R28	922	R28	922
	Removable KneePanel 32w	R32	950	R32	950
	Removable KneePanel 36w	R36	977	R36	977

(See Notes and Options on the opposite page.)

Specify: Product Number
Quantity
Color/Finish
Tagging

‡ Requires field sub-assembly.

Pedestals (cont.)



! Notes:

To order, specify the Product Number listed at top, then list the Spec Codes in L to R order in your description.
 The maximum width of a pedestal run under one shell is 120 inches.
 The total price is the sum of the Spec Code prices you itemized.
 Order Shells for Desks, Runoffs, Bridges and Credenzas separately, from the listings on prior pages.
 Utility Drawers include a vent/cord exit in the rear panel.
 Cabinet doors have soft-close hinges.

+ Options:

Specify metal pull and toeboard finish: MSBN Satin Brushed Nickel or MPNA Polished Natural Aluminum;
 (for MPNA Polished Natural Aluminum, refer to Wilsonart® 6251-419).
 Face Locks are included on all drawer and door pedestals. For no locks, specify Option NL.
 For ventilation cutout (where not included), specify Option VS; add \$506.
 For a secondary Wood1 selection on door/drawer fronts, specify Option W1F; add \$296.
 For finished left side, specify Option FL; add \$238.
 For finished right side, specify Option FR; add \$238.
 For finished both sides, specify Option FS; add \$477.

Support Keels



‡	w	2d	1h	MRB Resin Black	
Support Keel: 56	56			LG-56	487
Support Keel: 60	60			LG-60	503
Support Keel: 64	64			LG-64	508
Support Keel: 72	72			LG-72	517
Support Keel: 80	80			LG-80	527
• Support Keel: 88	88			LG-88	538

! Notes:

Required for unsupported work surface spans of 56 inches or more.
 Unit is an MRB Resin Black, 1 x 2 steel tube screwed to the underside of the work surface.

Specify: Product Number
 Quantity
 Color/Finish
 Tagging

‡ Requires field sub-assembly.

Gallery Tops, 10.8d 0.5th*

	Wood1		SolidSurf Matte		BPGlass		Carrara Marble		MRBAS Br Alum/St	
Gallery Top 40w	PZGTW40	969	PZGTC40	1350	PZGTG40	1844	PZGTS40	2107	PZGTA40	4069
Gallery Top 44w	PZGTW44	979	PZGTC44	1391	PZGTG44	1932	PZGTS44	2224	PZGTA44	4381
Gallery Top 48w	PZGTW48	992	PZGTC48	1430	PZGTG48	2018	PZGTS48	2339	PZGTA48	4690
Gallery Top 52w	PZGTW52	1004	PZGTC52	1471	PZGTG52	2107	PZGTS52	2456	PZGTA52	5004
Gallery Top 56w	PZGTW56	1013	PZGTC56	1508	PZGTG56	2201	PZGTS56	2573	PZGTA56	5315
Gallery Top 60w	PZGTW60	1026	PZGTC60	1550	PZGTG60	2287	PZGTS60	2688	PZGTA60	5627
Gallery Top 64w	PZGTW64	1035	PZGTC64	1591	PZGTG64	2376	PZGTS64	2802	PZGTA64	5937
Gallery Top 68w	PZGTW68	1046	PZGTC68	1633	PZGTG68	2466	PZGTS68	2918	PZGTA68	6250
Gallery Top 72w	PZGTW72	1057	PZGTC72	1674	PZGTG72	2555	PZGTS72	3035	PZGTA72	6565
Gallery Top 76w	PZGTW76	1066	PZGTC76	1714	PZGTG76	2644	PZGTS76	3150	PZGTA76	6873
Gallery Top 80w	PZGTW80	1079	PZGTC80	1755	PZGTG80	2731	PZGTS80	3267	PZGTA80	7186
Gallery Top 84w	PZGTW84	1089	PZGTC84	1792	PZGTG84	2820	PZGTS84	3382	PZGTA84	7499
Gallery Top 88w	PZGTW88	1100	PZGTC88	1833	PZGTG88	2913	PZGTS88	3499	PZGTA88	7808
Gallery Top 92w	PZGTW92	1110	PZGTC92	1872	PZGTG92	2999	PZGTS92	3612	PZGTA92	8122
Gallery Top 96w	PZGTW96	1119	PZGTC96	1914	PZGTG96	3086	PZGTS96	3731	PZGTA96	8430
Gallery Top 100w	PZGTW100	1132	PZGTC100	1952	PZGTG100	3178	PZGTS100	3845	PZGTA100	8744
Gallery Top 104w	PZGTW104	1142	PZGTC104	1993	-	-	PZGTS104	3964	PZGTA104	9055
Gallery Top 108w	PZGTW108	1153	PZGTC108	2033	-	-	PZGTS108	4077	PZGTA108	9369
Gallery Top 112w	PZGTW112	1163	PZGTC112	2071	-	-	PZGTS112	4195	PZGTA112	9679
Gallery Top 116w	PZGTW116	1175	PZGTC116	2113	-	-	PZGTS116	4307	PZGTA116	9993
Gallery Top 120w	PZGTW120	1185	PZGTC120	2151	-	-	PZGTS120	4423	PZGTA120	10304
Gallery Top 124w	PZGTW124	1198	PZGTC124	2195	-	-	PZGTS124	4540	PZGTA124	10612

! Notes:

To order, specify product number and list price is as shown; Identify which gallery is to receive each specified top.

* All tops are 0.5 inch thick plus a 0.25 inch subtop reveal spacer.

Solid Surface is Avonite® 8016 White, Matte.

+ Options/Parametrics:

Width range: 10-124; specify by replacing the last digits of the product number and use next larger standard size for pricing.

BPGlass (Back-Painted) available in (S.BLK) Black or (S.BWT) White.

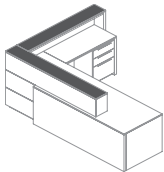

Gallery Backsplashes, 12.2h 1.5th

	Wood1/Magnet		SolidSurf Gloss		BPGlass/Magnet		Metal/Magnet	
Gallery Backsplash 40w	PZGBW40	1658	PZGBC40	1880	PZGBG40	2030	PZGBMM40	1692
Gallery Backsplash 44w	PZGBW44	1700	PZGBC44	1936	PZGBG44	2098	PZGBMM44	1729
Gallery Backsplash 48w	PZGBW48	1744	PZGBC48	1994	PZGBG48	2172	PZGBMM48	1767
Gallery Backsplash 52w	PZGBW52	1785	PZGBC52	2050	PZGBG52	2243	PZGBMM52	1807
Gallery Backsplash 56w	PZGBW56	1827	PZGBC56	2107	PZGBG56	2315	PZGBMM56	1845
Gallery Backsplash 60w	PZGBW60	1867	PZGBC60	2166	PZGBG60	2386	PZGBMM60	1882
Gallery Backsplash 64w	PZGBW64	1906	PZGBC64	2220	PZGBG64	2457	PZGBMM64	1920
Gallery Backsplash 68w	PZGBW68	1949	PZGBC68	2279	PZGBG68	2527	PZGBMM68	1959
Gallery Backsplash 72w	PZGBW72	1991	PZGBC72	2334	PZGBG72	2601	PZGBMM72	1998
Gallery Backsplash 76w	PZGBW76	2032	PZGBC76	2393	PZGBG76	2672	PZGBMM76	2035
Gallery Backsplash 80w	PZGBW80	2071	PZGBC80	2450	PZGBG80	2746	PZGBMM80	2075
Gallery Backsplash 84w	PZGBW84	2113	PZGBC84	2508	PZGBG84	2817	PZGBMM84	2112
Gallery Backsplash 88w	PZGBW88	2155	PZGBC88	2563	PZGBG88	2888	PZGBMM88	2150
Gallery Backsplash 92w	PZGBW92	2199	PZGBC92	2621	PZGBG92	2959	PZGBMM92	2186
Gallery Backsplash 96w	PZGBW96	2240	PZGBC96	2678	PZGBG96	3033	PZGBMM96	2227

! Notes:

To order, specify product number and list price is as shown; Identify which gallery is to receive each specified backsplash.

Wood1 includes all Wood1 veneer species and solid paint colors; inquire regarding other species/colors.

Standard Metal finish is MSBN Satin Brushed Nickel.

Acrylic Solid Surface standard is Avonite® 8016 White, Polished.

All Backsplash Panels with the Magnet designation accept CNL Magnets listed on the following page.

For widths greater than what is listed, combine two or more panels as needed to fill the desired opening.

+ Options/Parametrics:

Width range: 10-124; specify by replacing the last digits of the product number and use next larger standard size for pricing.

BPGlass (Back-Painted) available in (S.BLK) Black or (S.BWT) White.

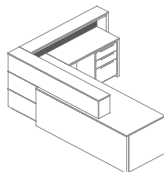

Specify: Product Number
Quantity
Color/Finish
Tagging

‡ Requires field sub-assembly.

Gallery Backsplash Magnet



For Magnet-Ready Backsplashes	w	d	Product No.	\$
Magnet	0.8	0.8	CNL	122

! Note:
Standard finish is MRBS Resin Brushed Steel.

Gallery & Surround Tackboards

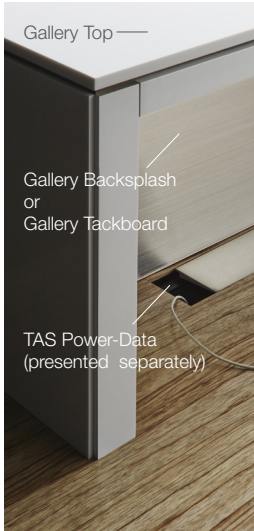

12.2h 1th	w	yds	Prod.No.	COM	F1	F2	F3	F4	F5	F6	F7	F8
Tackboard 40w	40	1.3	PZFT40	532	619	630	641	654	669	685	704	724
Tackboard 44w	44	1.4	PZFT44	565	659	670	683	697	712	730	750	772
Tackboard 48w	48	1.5	PZFT48	632	733	745	758	773	790	809	830	854
Tackboard 52w	52	1.6	PZFT52	680	787	800	814	830	848	869	891	917
Tackboard 56w	56	1.7	PZFT56	735	849	863	878	895	914	936	959	987
Tackboard 60w	60	1.8	PZFT60	813	934	948	964	982	1002	1025	1051	1079
Tackboard 64w	64	1.9	PZFT64	845	972	988	1005	1024	1045	1069	1096	1126
Tackboard 68w	68	2.1	PZFT68	888	1029	1046	1064	1085	1109	1136	1165	1199
Tackboard 72w	72	2.2	PZFT72	907	1054	1072	1092	1114	1138	1167	1197	1233
Tackboard 76w	76	2.3	PZFT76	931	1085	1104	1124	1147	1173	1202	1235	1271
Tackboard 80w	80	2.4	PZFT80	962	1123	1142	1164	1188	1214	1245	1279	1317
Tackboard 84w	84	2.5	PZFT84	991	1159	1179	1201	1226	1254	1286	1321	1361
Tackboard 88w	88	2.6	PZFT88	1020	1194	1215	1238	1264	1293	1327	1363	1405
Tackboard 92w	92	2.7	PZFT92	1046	1227	1249	1273	1300	1330	1365	1402	1446
Tackboard 96w	96	2.8	PZFT96	1110	1298	1320	1345	1373	1404	1440	1480	1524
Tackboard 100w	100	2.9	PZFT100	1137	1331	1355	1381	1410	1442	1479	1520	1566
Tackboard 104w	104	3.1	PZFT104	1166	1374	1399	1426	1457	1492	1532	1575	1625
Tackboard 108w	108	3.2	PZFT108	1198	1412	1438	1467	1499	1534	1576	1620	1672
Tackboard 112w	112	3.3	PZFT112	1229	1450	1477	1506	1539	1576	1618	1665	1717
Tackboard 116w	116	3.4	PZFT116	1260	1488	1515	1546	1580	1617	1661	1709	1763
Tackboard 120w	120	3.5	PZFT120	1304	1539	1567	1598	1633	1672	1717	1766	1822
Tackboard 124w	124	3.6	PZFT124	1357	1598	1627	1659	1695	1735	1782	1832	1890

	w	yds	Prod.No.	F9	F10	F11	F12	F13	F14	F15	F16	F17
Tackboard 40w	40	1.3	PZFT40	748	774	802	835	871	912	957	1009	1066
Tackboard 44w	44	1.4	PZFT44	797	825	856	891	930	974	1023	1079	1140
Tackboard 48w	48	1.5	PZFT48	881	911	944	982	1024	1070	1123	1183	1249
Tackboard 52w	52	1.6	PZFT52	946	978	1013	1053	1098	1147	1203	1267	1338
Tackboard 56w	56	1.7	PZFT56	1017	1051	1089	1131	1179	1231	1291	1359	1434
Tackboard 60w	60	1.8	PZFT60	1112	1148	1187	1232	1283	1339	1402	1474	1553
Tackboard 64w	64	1.9	PZFT64	1160	1198	1240	1288	1341	1400	1466	1542	1626
Tackboard 68w	68	2.1	PZFT68	1237	1279	1325	1377	1436	1501	1575	1659	1751
Tackboard 72w	72	2.2	PZFT72	1272	1316	1365	1420	1481	1549	1626	1714	1811
Tackboard 76w	76	2.3	PZFT76	1313	1359	1409	1467	1531	1603	1683	1775	1876
Tackboard 80w	80	2.4	PZFT80	1360	1408	1461	1521	1588	1663	1747	1843	1948
Tackboard 84w	84	2.5	PZFT84	1406	1456	1511	1574	1644	1721	1809	1909	2019
Tackboard 88w	88	2.6	PZFT88	1452	1504	1561	1626	1699	1779	1870	1974	2089
Tackboard 92w	92	2.7	PZFT92	1494	1548	1608	1675	1751	1834	1929	2037	2156
Tackboard 96w	96	2.8	PZFT96	1575	1631	1692	1762	1841	1928	2026	2138	2261
Tackboard 100w	100	2.9	PZFT100	1618	1676	1740	1813	1894	1984	2085	2201	2329
Tackboard 104w	104	3.1	PZFT104	1681	1743	1811	1888	1975	2071	2180	2304	2440
Tackboard 108w	108	3.2	PZFT108	1729	1793	1864	1944	2033	2132	2244	2372	2513
Tackboard 112w	112	3.3	PZFT112	1777	1843	1915	1998	2090	2193	2308	2440	2585
Tackboard 116w	116	3.4	PZFT116	1824	1892	1967	2052	2147	2253	2372	2508	2657
Tackboard 120w	120	3.5	PZFT120	1885	1955	2032	2120	2218	2326	2449	2589	2743
Tackboard 124w	124	3.6	PZFT124	1955	2027	2106	2196	2297	2408	2534	2678	2837

! Notes:
To order, specify Product Number; list price is as shown by fabric grade.
Identify which gallery or panel is to receive each specified tackboard.
Yardage requirements shown above are sufficient to cover up to four panels, assuming 54w material.
IMPORTANT: Refer to the Upholstery Guide on p.8 of the TUOHY List Price Schedule for COM fabric ordering information.
+ Options/Parametrics:
Width range: 10-124; replace the last digits of the Prod.No. and use the next larger standard size for price and yardage.



Gallery Surround Panels
Wood1
Unframed

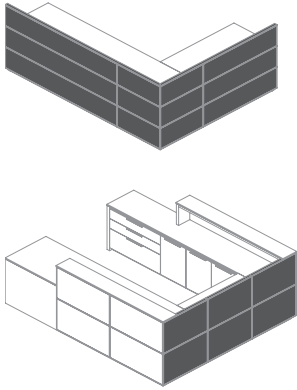

2d 43.8h	Prefix Code/Width Code:		Matrix Code:		
	PZG1W...1x1	...1x2	...1x3
Gallery/Surround W1 21w	...21...		4161	5333	6350
Gallery/Surround W1 24w	...24...		4356	5520	6549
Gallery/Surround W1 28w	...28...		4524	5697	6723
Gallery/Surround W1 32w	...32...		4660	5838	6862
Gallery/Surround W1 36w	...36...		4807	5982	7009
Gallery/Surround W1 40w	...40...		4925	6098	7126
Gallery/Surround W1 44w	...44...		5033	6200	7218
Gallery/Surround W1 48w	...48...		5147	6319	7337
Gallery/Surround W1 52w	...52...		5270	6432	7453
Gallery/Surround W1 56w	...56...		5494	6660	7680
Gallery/Surround W1 60w	...60...		5639	6806	7826
Gallery/Surround W1 64w	...64...		5771	6941	7961
Gallery/Surround W1 68w	...68...		5910	7081	8101
Gallery/Surround W1 72w	...72...		6056	7230	8248
Gallery/Surround W1 76w	...76...		6208	7383	8399
Gallery/Surround W1 80w	...80...		6338	7510	8534
Gallery/Surround W1 84w	...84...		6468	7636	8669
Gallery/Surround W1 88w	...88...		6606	7775	8811
Gallery/Surround W1 92w	...92...		6744	7914	8947
Gallery/Surround W1 96w	...96...		6886	8051	9085
Gallery/Surround W1 100w	...100...		7016	8190	9204
Gallery/Surround W1 104w	...104...		7504	8707	9626
Gallery/Surround W1 108w	...108...		7643	8845	9765
Gallery/Surround W1 112w	...112...		7804	8989	9924
Gallery/Surround W1 116w	...116...		7935	9131	10064
Gallery/Surround W1 120w	...120...		8065	9258	10193
Gallery/Surround W1 124w	...124...		8202	9400	10334

! Notes:
Determine product number by merging Prefix, Width and Matrix Codes; reference the price. Ex: PZG1W211X1 = \$4161.
+ Options/Parametrics:
Width range: 8-124; specify as Width Code and use next larger standard size for pricing.

PT17 Satin White

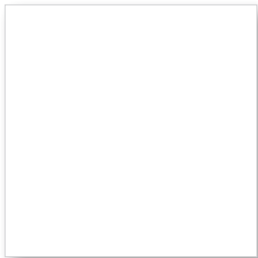

PT07 Matte Ebony



TUOHY Wood1 Species/Finishes, unframed.
19 standard hardwood offers, plus four solid color offerings.

TUOHY Wood2 species and finishes are also readily available, as are all the world's finest natural and reconstituted veneers. Inquire with Customer Service for a full presentation.

Specify: Product Number
Quantity
Color/Finish
Tagging

‡ Requires field sub-assembly.

TUOHY

Galleries for Desks & Credenzas
Wood1
Unframed

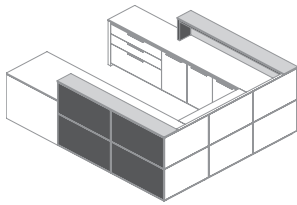

		Prefix Code/Width Code:	Matrix Code:								
10.8d	43.8h	PZG2W...	...1x1	...1x2	...1x3	...2x1	...2x2	...2x3	...3x1	...3x2	...3x3
Gallery/DeskCred W1 76w76...	8918	10547	11789	9339	10899	12620	9645	11264	12443
Gallery/DeskCred W1 80w80...	9046	10679	11922	9472	11029	12750	9755	11352	12554
Gallery/DeskCred W1 84w84...	9173	10797	12053	9601	11162	12880	9843	11483	12664
Gallery/DeskCred W1 88w88...	9347	10973	12227	9778	11335	13056	10061	11699	12880
Gallery/DeskCred W1 92w92...	9479	11105	12357	9907	11466	13188	10169	11789	12991
Gallery/DeskCred W1 96w96...	9615	11243	12496	10046	11606	13327	10285	11926	13107
Gallery/DeskCred W1 100w100...	9743	11375	12604	10163	11736	13457	10463	12103	13283
Gallery/DeskCred W1 104w104...	10224	11884	13019	10659	12193	14069	11316	12846	13851
Gallery/DeskCred W1 108w108...	10351	12015	13150	10787	12320	14201	11423	12979	13962
Gallery/DeskCred W1 112w112...	10529	12174	13327	10966	12496	14377	11645	13195	14178
Gallery/DeskCred W1 116w116...	10659	12315	13464	11105	12636	14514	11759	13290	14292
Gallery/DeskCred W1 120w120...	10835	12486	13641	11280	12808	14688	11913	13464	14449
Gallery/DeskCred W1 124w124...	10966	12620	13769	11409	12941	14820	12067	13641	14624

! Notes:

Determine product number by merging Prefix, Width and Matrix Codes; reference the price. Ex: PZG2W761X1 = \$8918.
Order Gallery Top and Backsplash separately and tag to your selection here.
Designate placement of Gallery on Desk or Credenza as user's Left, Center or Right.

+ Options/Parametrics:

Width range: 60-124; specify as Width Code and use next larger standard size for pricing.

Galleries for Runoffs
Wood1
Unframed

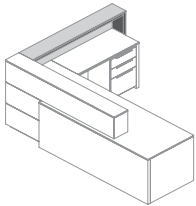

		Prefix Code/Width Code:	Matrix Code:								
10.8d	43.8h	PZG3W...	...1x1	...1x2	...1x3	...2x1	...2x2	...2x3	...3x1	...3x2	...3x3
Gallery/Runoff W1 40w LH40L...	6717	7888	8873	7137	8254	9158	7430	8590	9509
Gallery/Runoff W1 40w RH40R...	6717	7888	8873	7137	8254	9158	7430	8590	9509
Gallery/Runoff W1 48w LH48L...	6975	8145	9121	7410	8524	9428	7658	8815	9732
Gallery/Runoff W1 48w RH48R...	6975	8145	9121	7410	8524	9428	7658	8815	9732
Gallery/Runoff W1 56w LH56L...	7241	8406	9383	7671	8783	9689	7940	9077	10019
Gallery/Runoff W1 56w RH56R...	7241	8406	9383	7671	8783	9689	7940	9077	10019
Gallery/Runoff W1 64w LH64L...	7502	8673	9654	7923	9055	9959	8231	9391	10307
Gallery/Runoff W1 64w RH64R...	7502	8673	9654	7923	9055	9959	8231	9391	10307
Gallery/Runoff W1 72w LH72L...	7809	8983	9959	8231	9332	10267	8496	9654	10570
Gallery/Runoff W1 72w RH72R...	7809	8983	9959	8231	9332	10267	8496	9654	10570
Gallery/Runoff W1 80w LH80L...	8070	9245	10224	8496	9594	10529	8777	9916	10855
Gallery/Runoff W1 80w RH80R...	8070	9245	10224	8496	9594	10529	8777	9916	10855
Gallery/Runoff W1 88w LH88L...	8333	9497	10493	8768	9863	10797	9046	10230	11145
Gallery/Runoff W1 88w RH88R...	8333	9497	10493	8768	9863	10797	9046	10230	11145
Gallery/Runoff W1 96w LH96L...	8596	9761	10753	9026	10125	11061	9265	10446	11363
Gallery/Runoff W1 96w RH96R...	8596	9761	10753	9026	10125	11061	9265	10446	11363

! Notes:

Determine product number by merging Prefix, Width and Matrix Codes; reference the price. Ex: PZG3W40L1X1 = \$6717.
Order Gallery Top and Backsplash separately and tag to your selection here.

+ Options/Parametrics:

Width range: 32-96; specify as Width Code and use next larger standard size for pricing.

Galleries for Bridges
Wood1
Unframed

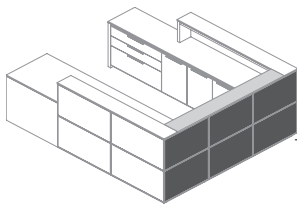

		Prefix Code/Width Code:	Matrix Code:								
10.8d	43.8h	PZG4W...	...1x1	...1x2	...1x3	...2x1	...2x2	...2x3	...3x1	...3x2	...3x3
Gallery/Bridge W1 96w (40)96...	7578	8282	9010	8004	8646	8797	8246	8966	9626
Gallery/Bridge W1 104w (48)104...	9332	10536	11409	9768	10839	11933	10402	11496	12219

! Notes:

Determine product number by merging Prefix, Width and Matrix Codes; reference the price. Ex: PZG4W961X1 = \$7578.
Order Gallery Top and Backsplash separately and tag to your selection here.

+ Options/Parametrics:

Width range: 92-104; specify as Width Code and use next larger standard size for pricing; bridge top must be 56-in less.

Specify: Product Number
Quantity
Color/Finish
Tagging

‡ Requires field sub-assembly.

Gallery Surround Panels
Polished Acrylic Solid Surface
Unframed

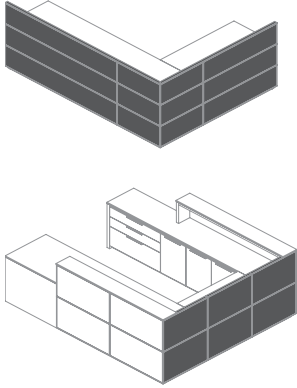

	Prefix Code/Width Code:	Matrix Code:		
2d 43.8h	PZG1C...	...1x1	...1x2	...1x3
Gallery/Surround CW 21w	...21...	6886	7504	8822
Gallery/Surround CW 24w	...24...	7218	7840	9174
Gallery/Surround CW 28w	...28...	7583	8202	9524
Gallery/Surround CW 32w	...32...	7914	8534	9858
Gallery/Surround CW 36w	...36...	8248	8866	10201
Gallery/Surround CW 40w	...40...	8553	9174	10493
Gallery/Surround CW 44w	...44...	8860	9479	10807
Gallery/Surround CW 48w	...48...	9168	9787	11121
Gallery/Surround CW 52w	...52...	9473	10091	11412
Gallery/Surround CW 56w	...56...	9887	10507	11836
Gallery/Surround CW 60w	...60...	10224	10843	12176
Gallery/Surround CW 64w	...64...	10553	11173	12487
Gallery/Surround CW 68w	...68...	10877	11496	12824
Gallery/Surround CW 72w	...72...	11207	11836	13145
Gallery/Surround CW 76w	...76...	11549	12176	13496
Gallery/Surround CW 80w	...80...	11871	12498	13822
Gallery/Surround CW 84w	...84...	12198	12824	14136
Gallery/Surround CW 88w	...88...	12524	13151	14471
Gallery/Surround CW 92w	...92...	12853	13482	14808
Gallery/Surround CW 96w	...96...	13182	13806	15120
Gallery/Surround CW 100w	...100...	13507	14136	15455
Gallery/Surround CW 104w	...104...	14298	14959	16339
Gallery/Surround CW 108w	...108...	14624	15286	16673
Gallery/Surround CW 112w	...112...	14977	15636	17029
Gallery/Surround CW 116w	...116...	15303	15966	17344
Gallery/Surround CW 120w	...120...	15626	16287	17669
Gallery/Surround CW 124w	...124...	15950	16613	18008

- ! Notes:
 Determine product number by merging Prefix, Width and Matrix Codes; reference the price. Ex: PZG1C211X1 = \$6886.
 Acrylic Solid Surface standard is Avonite® 8016 White, Polished.
 + Options/Parametrics:
 Width range: 8-124; specify as Width Code and use next larger standard size for pricing.



Polished Acrylic Solid Surface: Avonite® 8016 White, Polished, unframed.
 Other vendor colors and patterns are available on a project basis; contact Customer Service.

Specify: Product Number
 Quantity
 Color/Finish
 Tagging

‡ Requires field sub-assembly.

Galleries for Desks & Credenzas
Polished Acrylic Solid Surface
Unframed

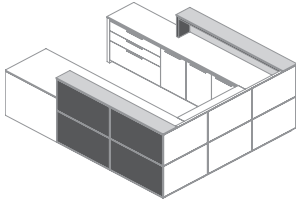

		Prefix Code/Width Code:		Matrix Code:								
10.8d	43.8h	PZG2C...	...1x1	...1x2	...1x3	...2x1	...2x2	...2x3	...3x1	...3x2	...3x3	
Gallery/DeskCred CW 76w	...76...	15841	16670	18738	16629	18247	20228	17442	19963	22591		
Gallery/DeskCred CW 80w	...80...	16161	16991	19070	16950	18550	20534	17705	20228	22829		
Gallery/DeskCred CW 84w	...84...	16483	17312	19375	17269	18887	20840	17948	20491	23069		
Gallery/DeskCred CW 88w	...88...	16846	17678	19747	17634	19237	21235	18451	20973	23617		
Gallery/DeskCred CW 92w	...92...	17164	17995	20075	17952	19570	21539	18691	21235	23856		
Gallery/DeskCred CW 96w	...96...	17497	18326	20388	18284	19886	21853	18960	21503	24104		
Gallery/DeskCred CW 100w	...100...	17814	18647	20714	18602	20222	22159	19419	21940	24543		
Gallery/DeskCred CW 104w	...104...	18594	19464	21591	19243	21140	23471	19963	22772	25306		
Gallery/DeskCred CW 108w	...108...	18916	19784	21920	19566	21444	23774	20228	23034	25614		
Gallery/DeskCred CW 112w	...112...	19278	20147	22289	19928	21824	24169	20730	23517	26094		
Gallery/DeskCred CW 116w	...116...	19607	20475	22602	20260	22137	24484	20978	23784	26342		
Gallery/DeskCred CW 120w	...120...	19975	20840	22976	20623	22516	24836	21284	24093	26627		
Gallery/DeskCred CW 124w	...124...	20294	21164	23306	20943	22821	25184	21743	24524	27129		

! Notes:
Determine product number by merging Prefix, Width and Matrix Codes; reference the price. Ex: PZG2C761X1= \$15841.
Order Gallery Top separately and tag to your selection here.
Designate placement of Gallery on Desk or Credenza as user's Left, Center or Right.
Acrylic Solid Surface standard is Avonite® 8016 White, Polished.

+ Options/Parametrics:
Width range: 60-124; specify as Width Code and use next larger standard size for pricing.

Galleries for Runoffs
Polished Acrylic Solid Surface
Unframed

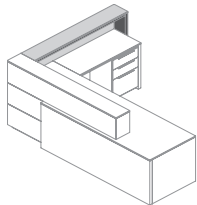

		Prefix Code/Width Code:		Matrix Code:								
10.8d	43.8h	PZG3C...	...1x1	...1x2	...1x3	...2x1	...2x2	...2x3	...3x1	...3x2	...3x3	
Gallery/Runoff CW 40w LH	...40L...	10913	11503	13094	11694	13063	14578	12511	14800	16940		
Gallery/Runoff CW 40w RH	...40R...	10913	11503	13094	11694	13063	14578	12511	14800	16940		
Gallery/Runoff CW 48w LH	...48L...	11563	12151	13757	12343	13712	15200	13019	15332	17431		
Gallery/Runoff CW 48w RH	...48R...	11563	12151	13757	12343	13712	15200	13019	15332	17431		
Gallery/Runoff CW 56w LH	...56L...	12203	12792	14390	12983	14354	15856	13739	16029	18173		
Gallery/Runoff CW 56w RH	...56R...	12203	12792	14390	12983	14354	15856	13739	16029	18173		
Gallery/Runoff CW 64w LH	...64L...	12853	13446	15032	13632	14999	16520	14449	16737	18856		
Gallery/Runoff CW 64w RH	...64R...	12853	13446	15032	13632	14999	16520	14449	16737	18856		
Gallery/Runoff CW 72w LH	...72L...	13529	14129	15707	14316	15690	17173	14996	17307	19447		
Gallery/Runoff CW 72w RH	...72R...	13529	14129	15707	14316	15690	17173	14996	17307	19447		
Gallery/Runoff CW 80w LH	...80L...	14172	14769	16366	14957	16329	17831	15715	18005	20125		
Gallery/Runoff CW 80w RH	...80R...	14172	14769	16366	14957	16329	17831	15715	18005	20125		
Gallery/Runoff CW 88w LH	...88L...	14820	15417	17006	15606	16976	18493	16421	18708	20875		
Gallery/Runoff CW 88w RH	...88R...	14820	15417	17006	15606	16976	18493	16421	18708	20875		
Gallery/Runoff CW 96w LH	...96L...	15462	16058	17641	16250	17619	19104	16926	19237	21357		
Gallery/Runoff CW 96w RH	...96R...	15462	16058	17641	16250	17619	19104	16926	19237	21357		

! Notes:
Determine product number by merging Prefix, Width and Matrix Codes; reference the price. Ex: PZG3C40L1X1= \$10913.
Order Gallery Top separately and tag to your selection here.
Acrylic Solid Surface standard is Avonite® 8016 White, Polished.

+ Options/Parametrics:
Width range: 32-96; specify as Width Code and use next larger standard size for pricing.

Galleries for Bridges
Polished Acrylic Solid Surface
Unframed

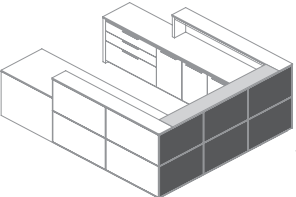

		Prefix Code/Width Code:		Matrix Code:								
10.8d	43.8h	PZG4C...	...1x1	...1x2	...1x3	...2x1	...2x2	...2x3	...3x1	...3x2	...3x3	
Gallery/Bridge CW 96w (40)	...96...	12329	12657	13692	13256	14098	14741	13889	15702	17407		
Gallery/Bridge CW 104w (48)	...104...	16479	17072	18655	17265	18618	20118	17942	20250	22392		

! Notes:
Determine product number by merging Prefix, Width and Matrix Codes; reference the price. Ex: PZG4C961X1= \$12329.
Order Gallery Top separately and tag to your selection here.
Acrylic Solid Surface standard is Avonite® 8016 White, Polished.

+ Options/Parametrics:
Width range: 92-104; specify as Width Code and use next larger standard size for pricing; bridge top must be 56-in less.

Specify: Product Number ‡ Requires field sub-assembly.
Quantity
Color/Finish
Tagging

Gallery Surround Panels
3Form® Reflect
Unframed

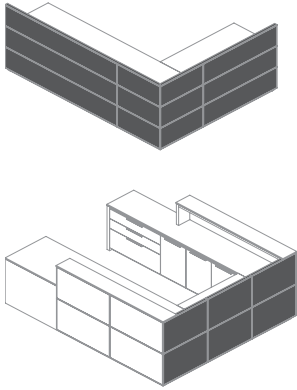

2d 43.8h	Prefix Code/Width Code:		Matrix Code:		
	PZG1F...	...1x1	...1x2	...1x3	
Gallery/Surround FR 21w	...21...	8470	9414	10267	
Gallery/Surround FR 24w	...24...	9326	10260	11121	
Gallery/Surround FR 28w	...28...	10377	11309	12170	
Gallery/Surround FR 32w	...32...	11389	12321	13182	
Gallery/Surround FR 36w	...36...	12402	13340	14201	
Gallery/Surround FR 40w	...40...	13391	14333	15192	
Gallery/Surround FR 44w	...44...	14384	15325	16183	
Gallery/Surround FR 48w	...48...	15370	16315	17173	
Gallery/Surround FR 52w	...52...	16360	17290	18167	
Gallery/Surround FR 56w	...56...	17460	18391	19268	
Gallery/Surround FR 60w	...60...	18480	19411	20265	
Gallery/Surround FR 64w	...64...	19487	20424	21279	
Gallery/Surround FR 68w	...68...	20498	21440	22289	
Gallery/Surround FR 72w	...72...	21519	22461	23311	
Gallery/Surround FR 76w	...76...	22536	23486	24337	
Gallery/Surround FR 80w	...80...	23546	24478	25345	
Gallery/Surround FR 84w	...84...	24557	25490	26356	
Gallery/Surround FR 88w	...88...	25562	26502	27370	
Gallery/Surround FR 92w	...92...	26576	27514	28383	

- ! Notes:
 Determine product number by merging Prefix, Width and Matrix Codes; reference the price. Ex: PZG1F211X1= \$8470.
 + Options/Parameters:
 Width range: 8-92; specify as Width Code and use next larger standard size for pricing.



3Form® Reflect, unframed.
 Other vendor colors and patterns are available on a project basis; contact Customer Service.

Specify: Product Number
 Quantity
 Color/Finish
 Tagging

‡ Requires field sub-assembly.

Galleries for Desks & Credenzas
3Form® Reflect
Unframed

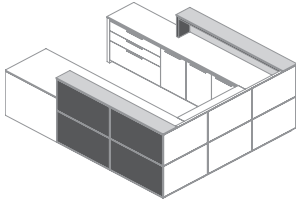

		Prefix Code/Width Code:		Matrix Code:								
10.8d	43.8h	PZG2F...	...1x1	...1x2	...1x3	...2x1	...2x2	...2x3	...3x1	...3x2	...3x3	
Gallery/DeskCred FR 76w	...76...	28265	28533	28774	28346	28595	28842	28646	28899	29148		
Gallery/DeskCred FR 80w	...80...	29272	29527	29782	29335	29601	29846	29409	29642	29912		
Gallery/DeskCred FR 84w	...84...	30277	30533	30786	30345	30606	30853	30174	30430	30681		
Gallery/DeskCred FR 88w	...88...	31319	31583	31837	31395	31655	31903	31685	31959	32207		
Gallery/DeskCred FR 92w	...92...	32324	32588	32844	32397	32660	32907	32451	32705	32976		
Gallery/DeskCred FR 96w	...96...	33341	33600	33854	33411	33672	33877	33221	33496	33746		
Gallery/DeskCred FR 100w	...100...	-	-	-	34417	34678	34882	34708	34985	35233		
Gallery/DeskCred FR 104w	...104...	-	-	-	35465	35802	36063	35561	35902	36198		
Gallery/DeskCred FR 108w	...108...	-	-	-	36471	36807	37069	36326	36689	36957		
Gallery/DeskCred FR 112w	...112...	-	-	-	37522	37858	38118	37858	38178	38490		
Gallery/DeskCred FR 116w	...116...	-	-	-	38535	38840	39130	38631	38971	39265		
Gallery/DeskCred FR 120w	...120...	-	-	-	39584	39888	40184	39438	39759	40072		
Gallery/DeskCred FR 124w	...124...	-	-	-	40589	40895	41189	40901	41242	41560		

! Notes:
Determine product number by merging Prefix, Width and Matrix Codes; reference the price. Ex: PZG2F761X1= \$28265.
Order Gallery Top separately and tag to your selection here.
Designate placement of Gallery on Desk or Credenza as user's Left, Center or Right.

+ Options/Parametrics:
Width range: 60-124; specify as Width Code and use next larger standard size for pricing.

Galleries for Runoffs
3Form® Reflect
Unframed

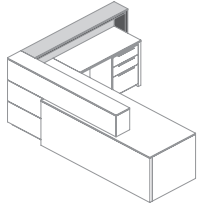

		Prefix Code/Width Code:		Matrix Code:								
10.8d	43.8h	PZG3F...	...1x1	...1x2	...1x3	...2x1	...2x2	...2x3	...3x1	...3x2	...3x3	
Gallery/Runoff FR 40w LH	...40L...	16452	16618	16788	16525	16692	16833	16833	16969	17135		
Gallery/Runoff FR 40w RH	...40R...	16452	16618	16788	16525	16692	16833	16833	16969	17135		
Gallery/Runoff FR 48w LH	...48L...	18461	18638	18807	18545	18708	18851	18347	18507	18675		
Gallery/Runoff FR 48w RH	...48R...	18461	18638	18807	18545	18708	18851	18347	18507	18675		
Gallery/Runoff FR 56w LH	...56L...	20475	20635	20817	20540	20725	20862	20600	20780	20927		
Gallery/Runoff FR 56w RH	...56R...	20475	20635	20817	20540	20725	20862	20600	20780	20927		
Gallery/Runoff FR 64w LH	...64L...	22486	22655	22815	22559	22712	22880	22859	23018	23188		
Gallery/Runoff FR 64w RH	...64R...	22486	22655	22815	22559	22712	22880	22859	23018	23188		
Gallery/Runoff FR 72w LH	...72L...	24543	24710	24871	24613	24768	24936	24434	24591	24760		
Gallery/Runoff FR 72w RH	...72R...	24543	24710	24871	24613	24768	24936	24434	24591	24760		
Gallery/Runoff FR 80w LH	...80L...	26547	26708	26881	26612	26777	26948	26686	26826	27013		
Gallery/Runoff FR 80w RH	...80R...	26547	26708	26881	26612	26777	26948	26686	26826	27013		
Gallery/Runoff FR 88w LH	...88L...	28557	28726	28899	28630	28797	28967	28922	29104	29272		
Gallery/Runoff FR 88w RH	...88R...	28557	28726	28899	28630	28797	28967	28922	29104	29272		
Gallery/Runoff FR 96w LH	...96L...	30568	30737	30910	30640	30809	30935	30452	30633	30803		
Gallery/Runoff FR 96w RH	...96R...	30568	30737	30910	30640	30809	30935	30452	30633	30803		

! Notes:
Determine product number by merging Prefix, Width and Matrix Codes; reference the price. Ex: PZG3F40L1X1= \$16452.
Order Gallery Top separately and tag to your selection here.

+ Options/Parametrics:
Width range: 32-96; specify as Width Code and use next larger standard size for pricing.

Galleries for Bridges
3Form® Reflect
Unframed

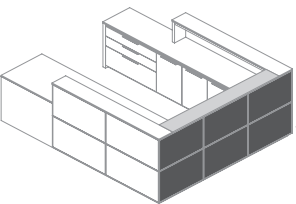

		Prefix Code/Width Code:		Matrix Code:								
10.8d	43.8h	PZG4F...	...1x1	...1x2	...1x3	...2x1	...2x2	...2x3	...3x1	...3x2	...3x3	
Gallery/Bridge FR 96w (40)	...96...	27799	27874	27965	27871	27947	27990	27684	27774	27857		
Gallery/Bridge FR 104w (48)	...104...	-	-	-	33699	33948	34126	33556	33829	34017		

! Notes:
Determine product number by merging Prefix, Width and Matrix Codes; reference the price. Ex: PZG4F961X1= \$27799.
Order Gallery Top separately and tag to your selection here.

+ Options/Parametrics:
Width range: 92-104; specify as Width Code and use next larger standard size for pricing; bridge top must be 56-in. less.

Specify: Product Number
Quantity
Color/Finish
Tagging

‡ Requires field sub-assembly.

Gallery Surround Panels
Carrara Marble
Unframed

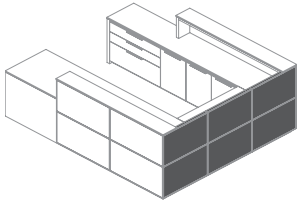
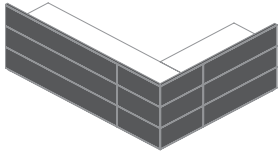

2d 43.8h	Prefix Code/Width Code:		Matrix Code:		
	PZG1S...1x1	...1x2	...1x3
Gallery/Surround SC 21w	...21...		7337	7694	8101
Gallery/Surround SC 24w	...24...		8051	8407	8822
Gallery/Surround SC 28w	...28...		8918	9268	9698
Gallery/Surround SC 32w	...32...		9748	10106	10515
Gallery/Surround SC 36w	...36...		10580	10936	11360
Gallery/Surround SC 40w	...40...		11389	11754	12156
Gallery/Surround SC 44w	...44...		12198	12554	12970
Gallery/Surround SC 48w	...48...		13008	13356	13784
Gallery/Surround SC 52w	...52...		13806	14173	14582
Gallery/Surround SC 56w	...56...		14726	15085	15505
Gallery/Surround SC 60w	...60...		15565	15914	16331
Gallery/Surround SC 64w	...64...		16393	16754	17169
Gallery/Surround SC 68w	...68...		17220	17575	17987
Gallery/Surround SC 72w	...72...		18058	18423	18827
Gallery/Surround SC 76w	...76...		18901	19261	19682
Gallery/Surround SC 80w	...80...		19726	20077	20492
Gallery/Surround SC 84w	...84...		20549	20911	21329
Gallery/Surround SC 88w	...88...		21380	21736	22143
Gallery/Surround SC 92w	...92...		22211	22560	22983
Gallery/Surround SC 96w	...96...		23044	23398	23820

- ! Notes:
 - Determine product number by merging Prefix, Width and Matrix Codes; reference the price. Ex: PZG1S211X1= \$7337.
 - Inquire with Customer Service for customer-supplied stone.
- + Options/Parametrics:
 - Width range: 8-96; specify as Width Code and specify as Width Code and use next larger standard size for pricing.



Carrara Marble, unframed.
Inquire with Customer Service about using customer-supplied stone.

Specify: Product Number
Quantity
Color/Finish
Tagging

‡ Requires field sub-assembly.

Galleries for Desks & Credenzas
Carrara Marble
Unframed

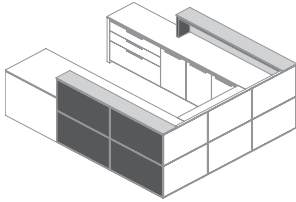

Prefix Code/Width Code:		Matrix Code:									
10.8d	43.8h	PZG2S...	...1x1	...1x2	...1x3	...2x1	...2x2	...2x3	...3x1	...3x2	...3x3
Gallery/DeskCred SC 76w	...76...	24630	25153	25585	24836	25385	25781	25438	26000	26414	
Gallery/DeskCred SC 80w	...80...	25452	25971	26392	25650	26217	26612	26073	26612	27049	
Gallery/DeskCred SC 84w	...84...	26270	26802	27223	26483	27021	27440	26686	27271	27684	
Gallery/DeskCred SC 88w	...88...	27137	27663	28077	27342	27894	28317	27953	28492	28887	
Gallery/DeskCred SC 92w	...92...	27957	28479	28908	28155	28726	29104	28586	29148	29520	
Gallery/DeskCred SC 96w	...96...	28793	29313	29747	28995	29531	29943	29206	29768	30160	
Gallery/DeskCred SC 100w	...100...	-	-	-	29812	30367	30772	30430	30993	31385	
Gallery/DeskCred SC 104w	...104...	-	-	-	30815	31548	32128	31329	32172	32805	
Gallery/DeskCred SC 108w	...108...	-	-	-	31647	32376	32961	31959	32783	33441	
Gallery/DeskCred SC 112w	...112...	-	-	-	32507	33251	33834	33207	34054	34708	
Gallery/DeskCred SC 116w	...116...	-	-	-	33330	34058	34672	33848	34672	35349	
Gallery/DeskCred SC 120w	...120...	-	-	-	34204	34935	35546	34505	35329	36026	
Gallery/DeskCred SC 124w	...124...	-	-	-	35021	35765	36333	35728	36552	37255	

! Notes:
Determine product number by merging Prefix, Width and Matrix Codes; reference the price. Ex: PZG2S761X1= \$24630.
Order Gallery Top separately and tag to your selection here.
Designate placement of Gallery on Desk or Credenza as user's Left, Center or Right.
Inquire with Customer Service for customer-supplied stone.

+ Options/Parametrics:
Width range: 60-124; specify as Width Code and specify as Width Code and use next larger standard size for pricing.

Galleries for Runoffs
Carrara Marble
Unframed

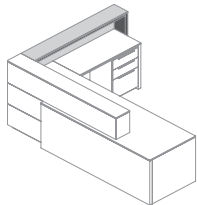

Prefix Code/Width Code:		Matrix Code:									
10.8d	43.8h	PZG3S...	...1x1	...1x2	...1x3	...2x1	...2x2	...2x3	...3x1	...3x2	...3x3
Gallery/Runoff SC 40w LH	...40L...	14677	15043	15365	14885	15280	15587	15491	15890	16200	
Gallery/Runoff SC 40w RH	...40R...	14677	15043	15365	14885	15280	15587	15491	15890	16200	
Gallery/Runoff SC 48w LH	...48L...	16329	16686	17037	16525	16918	17253	16743	17124	17475	
Gallery/Runoff SC 48w RH	...48R...	16329	16686	17037	16525	16918	17253	16743	17124	17475	
Gallery/Runoff SC 56w LH	...56L...	17970	18333	18675	18173	18550	18874	18583	18960	19268	
Gallery/Runoff SC 56w RH	...56R...	17970	18333	18675	18173	18550	18874	18583	18960	19268	
Gallery/Runoff SC 64w LH	...64L...	19623	19987	20322	19825	20222	20540	20424	20805	21132	
Gallery/Runoff SC 64w RH	...64R...	19623	19987	20322	19825	20222	20540	20424	20805	21132	
Gallery/Runoff SC 72w LH	...72L...	21306	21676	22003	21517	21895	22200	21735	22116	22444	
Gallery/Runoff SC 72w RH	...72R...	21306	21676	22003	21517	21895	22200	21735	22116	22444	
Gallery/Runoff SC 80w LH	...80L...	22951	23309	23645	23151	23558	23864	23571	23953	24302	
Gallery/Runoff SC 80w RH	...80R...	22951	23309	23645	23151	23558	23864	23571	23953	24302	
Gallery/Runoff SC 88w LH	...88L...	24600	24963	25295	24805	25197	25533	25417	25794	26101	
Gallery/Runoff SC 88w RH	...88R...	24600	24963	25295	24805	25197	25533	25417	25794	26101	
Gallery/Runoff SC 96w LH	...96L...	26246	26612	26952	26451	26831	27151	26663	27063	27368	
Gallery/Runoff SC 96w RH	...96R...	26246	26612	26952	26451	26831	27151	26663	27063	27368	

! Notes:
Determine product number by merging Prefix, Width and Matrix Codes; reference the price. Ex: PZG3S40L1X1= \$14677.
Order Gallery Top separately and tag to your selection here.
Inquire with Customer Service for customer-supplied stone.

+ Options/Parametrics:
Width range: 32-96; specify as Width Code and specify as Width Code and use next larger standard size for pricing.

Galleries for Bridges
Carrara Marble
Unframed

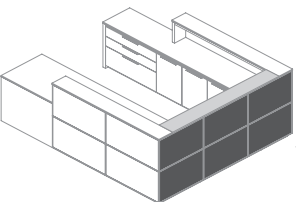

Prefix Code/Width Code:		Matrix Code:									
10.8d	43.8h	PZG4S...	...1x1	...1x2	...1x3	...2x1	...2x2	...2x3	...3x1	...3x2	...3x3
Gallery/Bridge SC 96w (40)	...96...	23701	23909	24164	23910	24126	24359	24121	24360	24579	
Gallery/Bridge SC 104w (48)	...104...	-	-	-	30788	31355	31881	31304	31969	32557	

! Notes:
Determine product number by merging Prefix, Width and Matrix Codes; reference the price. Ex: PZG4S961X1= \$23701.
Order Gallery Top separately and tag to your selection here.
Inquire with Customer Service for customer-supplied stone.

+ Options/Parametrics:
Width range: 92-104; specify as Width Code and use next larger standard size for pricing; bridge top must be 56-in less.

Specify: Product Number ‡ Requires field sub-assembly.
Quantity
Color/Finish
Tagging

Gallery Surround Panels
Satin Brushed Nickel
Uncaptured Frame

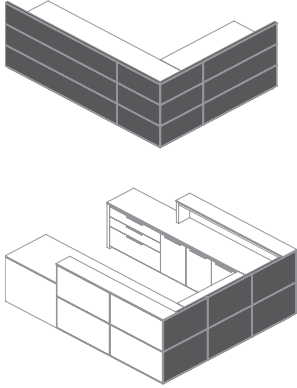

2d 43.8h	Prefix Code/Width Code:	Matrix Code:		
	PZG1BN...	...1x1	...1x2	...1x3
Gallery/Surround BN 21w	...21...	4960	6543	7314
Gallery/Surround BN 24w	...24...	5246	6862	7643
Gallery/Surround BN 28w	...28...	5531	7185	8034
Gallery/Surround BN 32w	...32...	5784	7483	8351
Gallery/Surround BN 36w	...36...	6046	7788	8694
Gallery/Surround BN 40w	...40...	6274	8034	9028
Gallery/Surround BN 44w	...44...	6505	8314	9321
Gallery/Surround BN 48w	...48...	6739	8591	9632
Gallery/Surround BN 52w	...52...	6966	8850	9947
Gallery/Surround BN 56w	...56...	7310	9240	10367
Gallery/Surround BN 60w	...60...	7562	9547	10711
Gallery/Surround BN 64w	...64...	7809	9827	11048
Gallery/Surround BN 68w	...68...	8065	10126	11383
Gallery/Surround BN 72w	...72...	8328	10434	11723
Gallery/Surround BN 76w	...76...	8591	10733	12073
Gallery/Surround BN 80w	...80...	8839	11024	12402
Gallery/Surround BN 84w	...84...	9094	11323	12739
Gallery/Surround BN 88w	...88...	9340	11607	13073
Gallery/Surround BN 92w	...92...	9595	11908	13385
Gallery/Surround BN 96w	...96...	9850	12206	13742

! Notes:
Determine product number by merging Prefix, Width and Matrix Codes; reference the price. Ex: PZG1BN211X1= \$4960.
+ Options/Parametrics:
Width range: 8-96; specify as Width Code and use next larger standard size for pricing.

Uncaptured frames
have no lip.



MSBN Satin Brushed Nickel, captured in an extruded MRBAS aluminum frame.

Specify: Product Number
Quantity
Color/Finish
Tagging

‡ Requires field sub-assembly.

Galleries for Desks & Credenzas
Satin Brushed Nickel
Uncaptured Frame

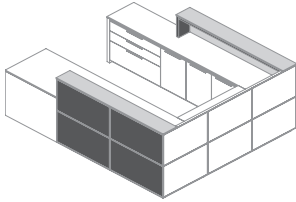

		Prefix Code/Width Code:	Matrix Code:								
10.8d	43.8h	PZG2BN...	...1x1	...1x2	...1x3	...2x1	...2x2	...2x3	...3x1	...3x2	...3x3
Gallery/DeskCred BN 76w	...76...	11780	14381	16950	12719	14834	16686	13739	16132	18675	
Gallery/DeskCred BN 80w	...80...	11988	14677	17277	12970	15112	17037	13937	16307	18916	
Gallery/DeskCred BN 84w	...84...	12233	14965	17602	13217	15391	17300	14135	16525	19222	
Gallery/DeskCred BN 88w	...88...	11128	15286	17978	13506	15707	17693	14527	17006	19638	
Gallery/DeskCred BN 92w	...92...	11375	15579	18303	13757	16016	18040	14704	17227	19943	
Gallery/DeskCred BN 96w	...96...	11576	15860	18638	14013	16298	18354	14928	17450	20192	
Gallery/DeskCred BN 100w	...100...	-	-	-	14244	16605	18705	15237	17845	20626	
Gallery/DeskCred BN 104w	...104...	-	-	-	14565	17029	19275	15587	18284	20606	
Gallery/DeskCred BN 108w	...108...	-	-	-	14812	17393	19534	15783	18545	20911	
Gallery/DeskCred BN 112w	...112...	-	-	-	15103	17656	19928	16153	19027	21459	
Gallery/DeskCred BN 116w	...116...	-	-	-	15359	17942	20283	16378	19207	21710	
Gallery/DeskCred BN 120w	...120...	-	-	-	15653	18289	20635	16598	19472	21991	
Gallery/DeskCred BN 124w	...124...	-	-	-	15883	18565	20984	16950	19908	22427	

! Notes:
Determine product number by merging Prefix, Width and Matrix Codes; reference the price. Ex: PZG2BN761X1= \$11780.
Order Gallery Top separately and tag to your selection here.
Designate placement of Gallery on Desk or Credenza as user's Left, Center or Right.

+ Options/Parametrics:
Width range: 60-124; specify as Width Code and use next larger standard size for pricing.

Galleries for Runoffs
Satin Brushed Nickel
Uncaptured Frame

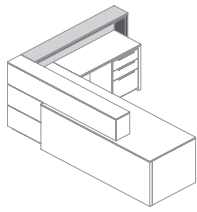

		Prefix Code/Width Code:	Matrix Code:								
10.8d	43.8h	PZG3BN...	...1x1	...1x2	...1x3	...2x1	...2x2	...2x3	...3x1	...3x2	...3x3
Gallery/Runoff BN 40w LH	...40L...	8465	10019	11803	9419	10907	12151	10420	12203	14165	
Gallery/Runoff BN 40w RH	...40R...	8465	10019	11803	9419	10907	12151	10420	12203	14165	
Gallery/Runoff BN 48w LH	...48L...	8962	10607	12466	9924	11496	12816	10819	12604	14719	
Gallery/Runoff BN 48w RH	...48R...	8962	10607	12466	9924	11496	12816	10819	12604	14719	
Gallery/Runoff BN 56w LH	...56L...	9450	11176	13101	10390	12053	13518	11345	13304	15395	
Gallery/Runoff BN 56w RH	...56R...	9450	11176	13101	10390	12053	13518	11345	13304	15395	
Gallery/Runoff BN 64w LH	...64L...	9947	11753	13784	10891	12640	14135	11922	13925	16145	
Gallery/Runoff BN 64w RH	...64R...	9947	11753	13784	10891	12640	14135	11922	13925	16145	
Gallery/Runoff BN 72w LH	...72L...	10483	12380	14464	11429	13268	14834	12357	14405	16670	
Gallery/Runoff BN 72w RH	...72R...	10483	12380	14464	11429	13268	14834	12357	14405	16670	
Gallery/Runoff BN 80w LH	...80L...	10973	12948	15118	11913	13821	15537	12880	15019	17415	
Gallery/Runoff BN 80w RH	...80R...	10973	12948	15118	11913	13821	15537	12880	15019	17415	
Gallery/Runoff BN 88w LH	...88L...	10120	13523	15807	12413	14381	16153	13433	15679	18099	
Gallery/Runoff BN 88w RH	...88R...	10120	13523	15807	12413	14381	16153	13433	15679	18099	
Gallery/Runoff BN 96w LH	...96L...	10529	14105	16442	12912	14965	16811	13827	16119	18647	
Gallery/Runoff BN 96w RH	...96R...	10529	14105	16442	12912	14965	16811	13827	16119	18647	

! Notes:
Determine product number by merging Prefix, Width and Matrix Codes; reference the price. Ex: PZG3BN40L1X1= \$8465.
Order Gallery Top separately and tag to your selection here.

+ Options/Parametrics:
Width range: 32-96; specify as Width Code and use next larger standard size for pricing.

Galleries for Bridges
Satin Brushed Nickel
Uncaptured Frame

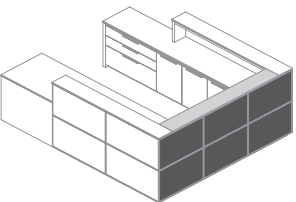

		Prefix Code/Width Code:	Matrix Code:								
10.8d	43.8h	PZG4BN...	...1x1	...1x2	...1x3	...2x1	...2x2	...2x3	...3x1	...3x2	...3x3
Gallery/Bridge BN 96w (40)	...96...	9028	11765	13561	11247	12985	14538	12124	14079	16287	
Gallery/Bridge BN 104w (48)	...104...	-	-	-	13057	15297	17134	13984	16389	18446	

! Notes:
Determine product number by merging Prefix, Width and Matrix Codes; reference the price. Ex: PZG4BN961X1= \$9028.
Order Gallery Top separately and tag to your selection here.

+ Options/Parametrics:
Width range: 92-104; specify as Width Code and use next larger standard size for pricing; bridge top must be 56-in less.

Specify: Product Number
Quantity
Color/Finish
Tagging

‡ Requires field sub-assembly.

Gallery Surround Panels
 Silix Faux Leather
 Unframed

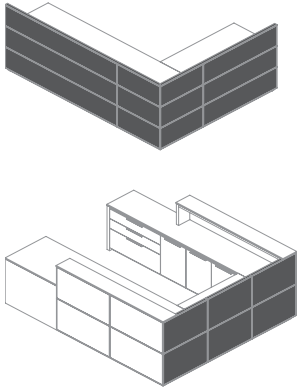

2d 43.8h	Prefix Code/Width Code:		Matrix Code:		
	PZG1P...1x1	...1x2	...1x3
Gallery/Surround PR 21w	...21...		4825	5581	6660
Gallery/Surround PR 24w	...24...		5112	5874	6941
Gallery/Surround PR 28w	...28...		5414	6161	7248
Gallery/Surround PR 32w	...32...		5673	6432	7499
Gallery/Surround PR 36w	...36...		5946	6698	7775
Gallery/Surround PR 40w	...40...		6183	6928	8023
Gallery/Surround PR 44w	...44...		6418	7174	8248
Gallery/Surround PR 48w	...48...		6660	7411	8496
Gallery/Surround PR 52w	...52...		6897	7658	8741
Gallery/Surround PR 56w	...56...		7248	7998	9078
Gallery/Surround PR 60w	...60...		7519	8274	9354
Gallery/Surround PR 64w	...64...		7782	8534	9601
Gallery/Surround PR 68w	...68...		8043	8803	9871
Gallery/Surround PR 72w	...72...		8314	9063	10149
Gallery/Surround PR 76w	...76...		8582	9332	10412
Gallery/Surround PR 80w	...80...		8839	9595	10674
Gallery/Surround PR 84w	...84...		9100	9850	10944
Gallery/Surround PR 88w	...88...		9362	10120	11192
Gallery/Surround PR 92w	...92...		9626	10377	11461
Gallery/Surround PR 96w	...96...		9887	10645	11709
Gallery/Surround PR 100w	...100...		10149	10901	11978
Gallery/Surround PR 104w	...104...		10625	11694	13101
Gallery/Surround PR 108w	...108...		10884	11952	13349
Gallery/Surround PR 112w	...112...		11164	12229	13641
Gallery/Surround PR 116w	...116...		11423	12498	13889
Gallery/Surround PR 120w	...120...		11682	12746	14150
Gallery/Surround PR 124w	...124...		11943	13016	14420

- ! Notes:
 - Determine product number by merging Prefix, Width and Matrix Codes; reference the price. Ex: PZG1P211X1= \$4825.
- + Options/Parametrics:
 - Width range: 8-124; specify as Width Code and use next larger standard size for pricing.



TUOHY Silix Faux Leather, unframed
 Available in 19 standard colors. Inquire regarding use of COM fabrics suitable for vertical application.

Specify: Product Number ‡ Requires field sub-assembly.
 Quantity
 Color/Finish
 Tagging

Galleries for Desks & Credenzas
Silex Faux Leather
Unframed

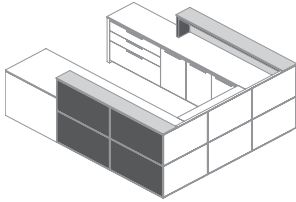

10.8d	43.8h	Prefix Code/Width Code:	Matrix Code:								
		PZG2P...	...1x1	...1x2	...1x3	...2x1	...2x2	...2x3	...3x1	...3x2	...3x3
Gallery/DeskCred PR 76w	...76...	...	11855	12792	14061	12254	13056	13932	12719	13609	14501
Gallery/DeskCred PR 80w	...80...	...	12109	13056	14324	12503	13304	14195	12919	13784	14742
Gallery/DeskCred PR 84w	...84...	...	12364	13304	14588	12750	13552	14455	13137	14005	14915
Gallery/DeskCred PR 88w	...88...	...	12664	13609	14874	13056	13873	14719	13529	14398	15332
Gallery/DeskCred PR 92w	...92...	...	12919	13860	15134	13304	14120	14981	13729	14615	15505
Gallery/DeskCred PR 96w	...96...	...	13181	14129	15380	13572	14377	15251	13953	14800	15751
Gallery/DeskCred PR 100w	...100...	...	13433	14377	15643	13821	14624	15513	14305	15147	16058
Gallery/DeskCred PR 104w	...104...	...	13900	15164	16759	14305	15134	16038	14785	15629	16494
Gallery/DeskCred PR 108w	...108...	...	14159	15411	16998	14565	15380	16298	14999	15807	16737
Gallery/DeskCred PR 112w	...112...	...	14449	15702	17307	14856	15672	16562	15395	16242	17155
Gallery/DeskCred PR 116w	...116...	...	14712	15972	17553	15125	15956	16833	15599	16421	17333
Gallery/DeskCred PR 120w	...120...	...	15007	16262	17858	15417	16250	17135	15860	16686	17553
Gallery/DeskCred PR 124w	...124...	...	15265	16525	18121	15679	16494	17401	16212	17037	17921

! Notes:
Determine product number by merging Prefix, Width and Matrix Codes; reference the price. Ex: PZG2P761X1= \$11855.
Order Gallery Top separately and tag to your selection here.
Designate placement of Gallery on Desk or Credenza as user's Left, Center or Right.
+ Options/Parametrics:
Width range: 60-124; specify as Width Code and use next larger standard size for pricing.

Galleries for Runoffs
Silex Faux Leather
Unframed

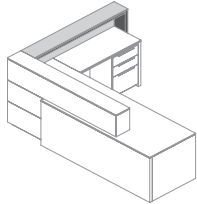

10.8d	43.8h	Prefix Code/Width Code:	Matrix Code:								
		PZG3P...	...1x1	...1x2	...1x3	...2x1	...2x2	...2x3	...3x1	...3x2	...3x3
Gallery/Runoff PR 40w LH	...40L...	...	8333	9085	10186	8730	9347	10053	9211	9871	10600
Gallery/Runoff PR 40w RH	...40R...	...	8333	9085	10186	8730	9347	10053	9211	9871	10600
Gallery/Runoff PR 48w LH	...48L...	...	8845	9601	10695	9233	9850	10542	9609	10274	11023
Gallery/Runoff PR 48w RH	...48R...	...	8845	9601	10695	9233	9850	10542	9609	10274	11023
Gallery/Runoff PR 56w LH	...56L...	...	9354	10112	11199	9743	10375	11067	10179	10839	11571
Gallery/Runoff PR 56w RH	...56R...	...	9354	10112	11199	9743	10375	11067	10179	10839	11571
Gallery/Runoff PR 64w LH	...64L...	...	9871	10630	11708	10259	10877	11600	10733	11417	12124
Gallery/Runoff PR 64w RH	...64R...	...	9871	10630	11708	10259	10877	11600	10733	11417	12124
Gallery/Runoff PR 72w LH	...72L...	...	10425	11181	12277	10813	11446	12124	11191	11855	12585
Gallery/Runoff PR 72w RH	...72R...	...	10425	11181	12277	10813	11446	12124	11191	11855	12585
Gallery/Runoff PR 80w LH	...80L...	...	10931	11694	12781	11323	11943	12646	11736	12422	13195
Gallery/Runoff PR 80w RH	...80R...	...	10931	11694	12781	11323	11943	12646	11736	12422	13195
Gallery/Runoff PR 88w LH	...88L...	...	11446	12210	13290	11840	12473	13137	12315	12996	13747
Gallery/Runoff PR 88w RH	...88R...	...	11446	12210	13290	11840	12473	13137	12315	12996	13747
Gallery/Runoff PR 96w LH	...96L...	...	11955	12719	13791	12350	12970	13663	12728	13391	14165
Gallery/Runoff PR 96w RH	...96R...	...	11955	12719	13791	12350	12970	13663	12728	13391	14165

! Notes:
Determine product number by merging Prefix, Width and Matrix Codes; reference the price. Ex: PZG3P40L1X1= \$8333.
Order Gallery Top separately and tag to your selection here.
+ Options/Parametrics:
Width range: 32-96; specify as Width Code and use next larger standard size for pricing.

Galleries for Bridges
Silex Faux Leather
Unframed

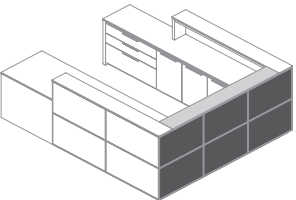

10.8d	43.8h	Prefix Code/Width Code:	Matrix Code:								
		PZG4P...	...1x1	...1x2	...1x3	...2x1	...2x2	...2x3	...3x1	...3x2	...3x3
Gallery/Bridge PR 96w (40)	...96...	...	10733	11316	12202	11128	11563	12073	11504	11988	12575
Gallery/Bridge PR 104w (48)	...104...	...	12934	14005	15410	13340	13977	14712	13777	14398	15147

! Notes:
Determine product number by merging Prefix, Width and Matrix Codes; reference the price. Ex: PZG4P961X1= \$10733.
Order Gallery Top separately and tag to your selection here.
+ Options/Parametrics:
Width range: 92-104; specify as Width Code and use next larger standard size for pricing; bridge top must be 56-in less.

Specify: Product Number
Quantity
Color/Finish
Tagging

‡ Requires field sub-assembly.

Gallery Surround Panels
Back-Painted Glass
Uncaptured Frame

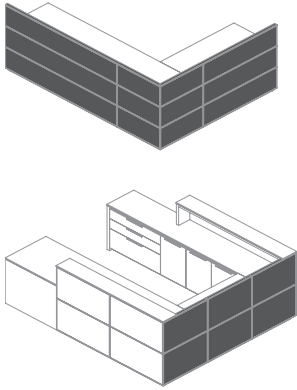

	Prefix Code/Width Code:	Matrix Code:		
2d 43.8h	PZG1GB...	...1x1	...1x2	...1x3
Gallery/Surround GB 21w	...21...	5842	7725	8254
Gallery/Surround GB 24w	...24...	6252	8156	8736
Gallery/Surround GB 28w	...28...	6701	8634	9258
Gallery/Surround GB 32w	...32...	7117	9094	9748
Gallery/Surround GB 36w	...36...	7546	9479	10267
Gallery/Surround GB 40w	...40...	7935	9984	10755
Gallery/Surround GB 44w	...44...	8335	10416	11220
Gallery/Surround GB 48w	...48...	8731	10855	11709
Gallery/Surround GB 52w	...52...	9122	11279	12176
Gallery/Surround GB 56w	...56...	9626	11825	12750
Gallery/Surround GB 60w	...60...	10056	12286	13268
Gallery/Surround GB 64w	...64...	10463	12737	13780
Gallery/Surround GB 68w	...68...	10884	13193	14270
Gallery/Surround GB 72w	...72...	11309	13663	14787
Gallery/Surround GB 76w	...76...	11738	14118	15286
Gallery/Surround GB 80w	...80...	12147	14575	15770
Gallery/Surround GB 84w	...84...	12569	15028	16278
Gallery/Surround GB 88w	...88...	-	15479	16788
Gallery/Surround GB 92w	...92...	-	15932	17277
Gallery/Surround GB 96w	...96...	-	16396	17787
Gallery/Surround GB 100w	...100...	-	-	18276

! Notes:
 Determine product number by merging Prefix, Width and Matrix Codes; reference the price. Ex: PZG1GB211X1= \$5842.
 + Options/Parametrics:
 Width range: 8-100; specify as Width Code and use next larger standard size for pricing.
 Specify Back-Painted Glass panels from (S.BLK Black) or (S.BWT) White.

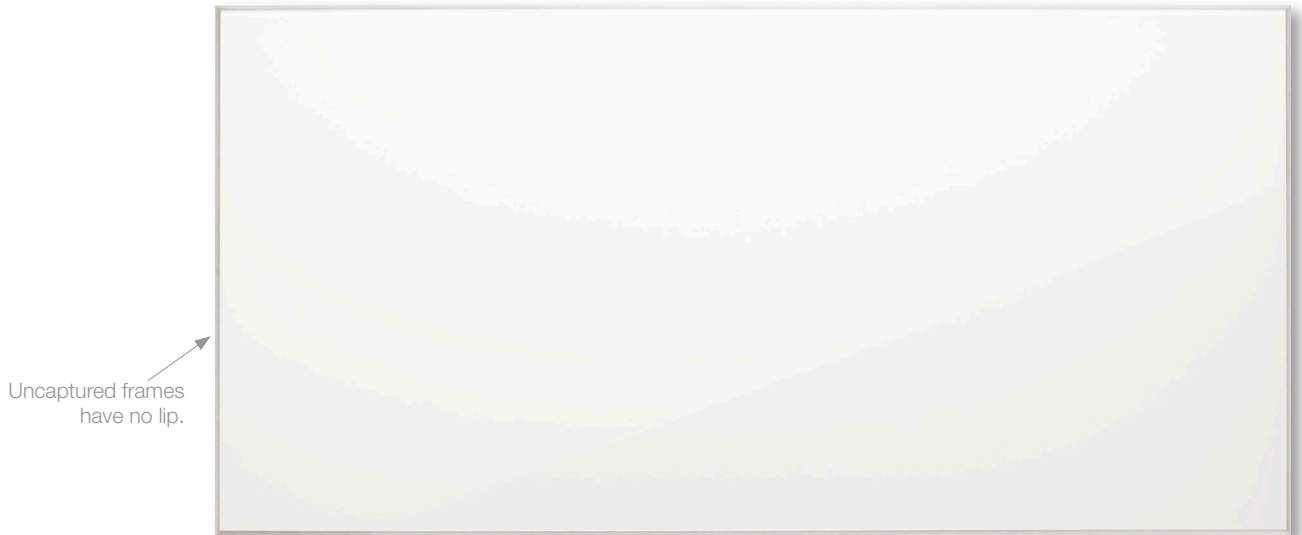

Back-Painted Glass, captured in an extruded MRBAS aluminum frame.
 Customer match paint colors for the glass may also be applied; contact Customer Service.

Specify: Product Number
 Quantity
 Color/Finish
 Tagging

‡ Requires field sub-assembly.

Galleries for Desks & Credenzas
Back-Painted Glass
Uncaptured Frame

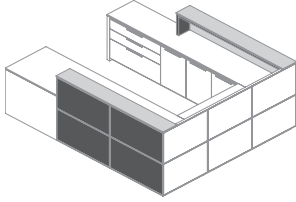

		Prefix Code/Width Code:		Matrix Code:								
10.8d	43.8h	PZG2GB...	...1x1	...1x2	...1x3	...2x1	...2x2	...2x3	...3x1	...3x2	...3x3	
Gallery/DeskCred GB 76w	...76...		15380	17750	20138	16540	18625	20534	17641	19994	22591	
Gallery/DeskCred GB 80w	...80...		15787	18203	20623	16950	19075	21016	17970	20344	22960	
Gallery/DeskCred GB 84w	...84...		16205	18655	21124	17370	19526	21452	18274	20654	23333	
Gallery/DeskCred GB 88w	...88...		-	19151	21650	17823	20024	22022	18906	21351	24073	
Gallery/DeskCred GB 92w	...92...		-	19600	22129	18229	20475	22499	19214	21743	24446	
Gallery/DeskCred GB 96w	...96...		-	20060	22640	18647	20937	23034	19551	22101	24826	
Gallery/DeskCred GB 100w	...100...		-	-	23142	19052	21387	23517	20118	22712	25527	
Gallery/DeskCred GB 104w	...104...		-	-	-	19534	21985	24258	20579	23283	25634	
Gallery/DeskCred GB 108w	...108...		-	-	-	19943	22523	24696	20927	23676	26073	
Gallery/DeskCred GB 112w	...112...		-	-	-	20411	22933	25221	21539	24373	26814	
Gallery/DeskCred GB 116w	...116...		-	-	-	20824	23389	25749	21877	24733	27196	
Gallery/DeskCred GB 120w	...120...		-	-	-	21277	23885	26277	22226	25079	27674	
Gallery/DeskCred GB 124w	...124...		-	-	-	21670	24365	26802	22815	25738	28309	

! Notes:
Determine product number by merging Prefix, Width and Matrix Codes; reference the price. Ex: PZG2GB761X1= \$15380.
Order Gallery Top separately and tag to your selection here.
Designate placement of Gallery on Desk or Credenza as user's Left, Center or Right.

+ Options/Parametrics:
Width range: 60-124; specify as Width Code and use next larger standard size for pricing.
Specify Back-Painted Glass panels from (S.BLK Black) or (S.BWT White).

Galleries for Runoffs
Back-Painted Glass
Uncaptured Frame

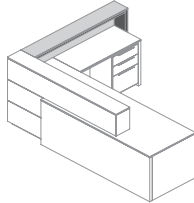

		Prefix Code/Width Code:		Matrix Code:								
10.8d	43.8h	PZG3GB...	...1x1	...1x2	...1x3	...2x1	...2x2	...2x3	...3x1	...3x2	...3x3	
Gallery/Runoff GB 40w LH	...40L...		10456	12015	13791	11409	12876	14165	12486	14244	16219	
Gallery/Runoff GB 40w RH	...40R...		10456	12015	13791	11409	12876	14165	12486	14244	16219	
Gallery/Runoff GB 48w LH	...48L...		11285	12924	14785	12233	13816	15177	13128	14952	17037	
Gallery/Runoff GB 48w RH	...48R...		11285	12924	14785	12233	13816	15177	13128	14952	17037	
Gallery/Runoff GB 56w LH	...56L...		12103	13827	15769	13050	14688	16182	14048	15956	18106	
Gallery/Runoff GB 56w RH	...56R...		12103	13827	15769	13050	14688	16182	14048	15956	18106	
Gallery/Runoff GB 64w LH	...64L...		12924	14725	16759	13873	15599	17110	14970	16969	19187	
Gallery/Runoff GB 64w RH	...64R...		12924	14725	16759	13873	15599	17110	14970	16969	19187	
Gallery/Runoff GB 72w LH	...72L...		13791	15690	17786	14749	16546	18157	15653	17712	19975	
Gallery/Runoff GB 72w RH	...72R...		13791	15690	17786	14749	16546	18157	15653	17712	19975	
Gallery/Runoff GB 80w LH	...80L...		14609	16576	18771	15549	17450	19164	16569	18719	21107	
Gallery/Runoff GB 80w RH	...80R...		14609	16576	18771	15549	17450	19164	16569	18719	21107	
Gallery/Runoff GB 88w LH	...88L...		-	17486	19762	16385	18362	20133	17475	19688	22189	
Gallery/Runoff GB 88w RH	...88R...		-	17486	19762	16385	18362	20133	17475	19688	22189	
Gallery/Runoff GB 96w LH	...96L...		-	18390	20745	17202	19268	21140	18106	20430	22933	
Gallery/Runoff GB 96w RH	...96R...		-	18390	20745	17202	19268	21140	18106	20430	22933	

! Notes:
Determine product number by merging Prefix, Width and Matrix Codes; reference the price. Ex: PZG3GB40L1X1= \$10456.
Order Gallery Top separately and tag to your selection here.

+ Options/Parametrics:
Width range: 32-96; specify as Width Code and use next larger standard size for pricing.
Specify Back-Painted Glass panels from (S.BLK Black) or (S.BWT White).

Galleries for Bridges
Back-Painted Glass
Uncaptured Frame

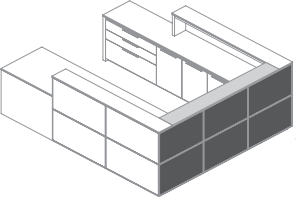

		Prefix Code/Width Code:		Matrix Code:								
10.8d	43.8h	PZG4GB...	...1x1	...1x2	...1x3	...2x1	...2x2	...2x3	...3x1	...3x2	...3x3	
Gallery/Bridge GB 96w (40)	...96...		-	16719	18851	15764	17598	19243	16666	18761	21037	
Gallery/Bridge GB 104w (48)	...104...		-	-	-	19382	21723	23856	20431	23060	25301	

! Notes:
Determine product number by merging Prefix, Width and Matrix Codes; reference the price. Ex: PZG4GB961X2= \$16719.
Order Gallery Top separately and tag to your selection here.

+ Options/Parametrics:
Width range: 92-104; specify as Width Code and use next larger standard size for pricing; bridge top must be 56-in less.
Specify Back-Painted Glass panels from (S.BLK Black) or (S.BWT White).

Specify: Product Number ‡ Requires field sub-assembly.
Quantity
Color/Finish
Tagging

Gallery Surround Panels
Stainless Steel Wire Mesh
Captured Frame

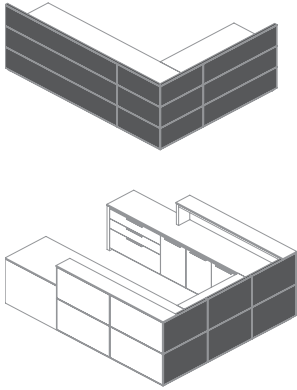

	Prefix Code/Width Code:	Matrix Code:		
2d 43.8h	PZG1WM...	...1x1	...1x2	...1x3
Gallery/Surround WM 21w	...21...	6294	7881	8627
Gallery/Surround WM 24w	...24...	6754	8363	9151
Gallery/Surround WM 28w	...28...	7271	8918	9765
Gallery/Surround WM 32w	...32...	7752	9451	10315
Gallery/Surround WM 36w	...36...	8248	9992	10901
Gallery/Surround WM 40w	...40...	8707	10470	11431
Gallery/Surround WM 44w	...44...	9168	10980	11964
Gallery/Surround WM 48w	...48...	9632	11491	12518
Gallery/Surround WM 52w	...52...	10091	11988	13073
Gallery/Surround WM 56w	...56...	10659	12604	13712
Gallery/Surround WM 60w	...60...	11155	13145	14298
Gallery/Surround WM 64w	...64...	11638	13647	14874
Gallery/Surround WM 68w	...68...	12115	14178	15427
Gallery/Surround WM 72w	...72...	12614	14719	16010
Gallery/Surround WM 76w	...76...	13109	15253	16599
Gallery/Surround WM 80w	...80...	13589	15775	17127
Gallery/Surround WM 84w	...84...	14070	16309	17701
Gallery/Surround WM 88w	...88...	14516	16811	18276
Gallery/Surround WM 92w	...92...	14959	17344	18827
Gallery/Surround WM 96w	...96...	15396	17875	19406
Gallery/Surround WM 100w	...100...	15843	18319	19850
Gallery/Surround WM 104w	...104...	16287	18766	20298
Gallery/Surround WM 108w	...108...	16722	19209	20740
Gallery/Surround WM 112w	...112...	17193	19660	21208
Gallery/Surround WM 116w	...116...	17636	20102	21628
Gallery/Surround WM 120w	...120...	18062	20543	22066
Gallery/Surround WM 124w	...124...	18507	20986	22512

! Notes:
Determine product number by merging Prefix, Width and Matrix Codes; reference the price. Ex: PZG1WM211X1 = \$6294.
+ Options/Parametrics:
Width range: 8-84; specify as Width Code and use next larger standard size for pricing.

Captured frames
have a 0.19-in lip.

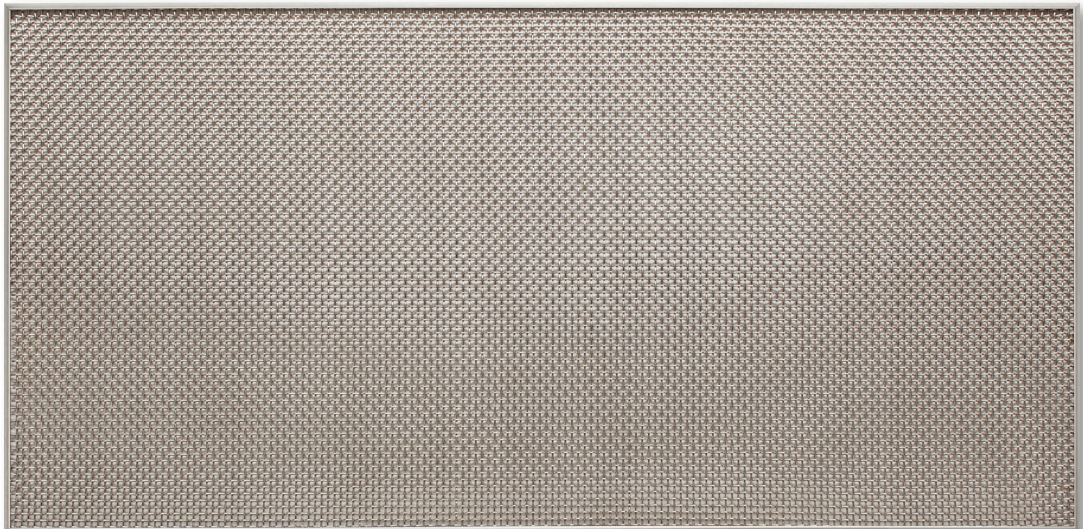

Stainless Steel Mesh #6, .047 Gauge, captured in an extruded MRBAS aluminum frame.
COM materials may also be applied; contact Customer Service.

Specify: Product Number
Quantity
Color/Finish
Tagging

‡ Requires field sub-assembly.

Galleries for Desks & Credenzas
Stainless Steel Wire Mesh
Captured Frame

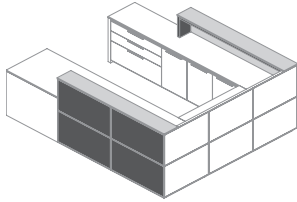

10.8d 43.8h	Prefix Code/Width Code:	Matrix Code:									
	PZG2WM...	...1x1	...1x2	...1x3	...2x1	...2x2	...2x3	...3x1	...3x2	...3x3	
Gallery/DeskCred WM 76w	...76...	17349	19951	22499	18289	20402	22239	19410	21803	24337	
Gallery/DeskCred WM 80w	...80...	17823	20460	23049	18771	20882	22808	19805	22197	24710	
Gallery/DeskCred WM 84w	...84...	18303	20984	23596	19249	21422	23333	20156	22547	25213	
Gallery/DeskCred WM 88w	...88...	18782	21539	24207	19777	21975	23900	20901	23377	26020	
Gallery/DeskCred WM 92w	...92...	19214	22065	24753	20260	22516	24470	21248	23811	26457	
Gallery/DeskCred WM 96w	...96...	19660	22596	25330	20730	23034	25046	21650	24169	26903	
Gallery/DeskCred WM 100w	...100...	20095	23034	25899	21200	23571	25614	22304	24913	27668	
Gallery/DeskCred WM 104w	...104...	20529	23457	26334	21750	24230	26401	22829	25527	27844	
Gallery/DeskCred WM 108w	...108...	20963	23894	26772	22231	24826	26922	23202	25962	28283	
Gallery/DeskCred WM 112w	...112...	21444	24373	27255	22756	25295	27540	23923	26794	29155	
Gallery/DeskCred WM 116w	...116...	21883	24818	27698	23245	25841	28113	24302	27151	29601	
Gallery/DeskCred WM 120w	...120...	22364	25301	28155	23770	26392	28726	24716	27590	30080	
Gallery/DeskCred WM 124w	...124...	22800	25738	28595	24237	26933	29295	25417	28331	30846	

! Notes:

Determine product number by merging Prefix, Width and Matrix Codes; reference the price. Ex: PZG2WM761X1= \$17349.
Order Gallery Top separately and tag to your selection here.

Designate placement of Gallery on Desk or Credenza as user's Left, Center or Right.

+ Options/Parametrics:

Width range: 60-124; specify as Width Code and use next larger standard size for pricing.

Galleries for Runoffs
Stainless Steel Wire Mesh
Captured Frame

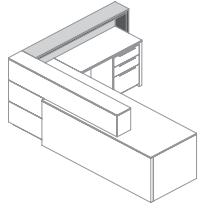

10.8d 43.8h	Prefix Code/Width Code:	Matrix Code:									
	PZG3WM...	...1x1	...1x2	...1x3	...2x1	...2x2	...2x3	...3x1	...3x2	...3x3	
Gallery/Runoff WM 40w LH	...40L...	11358	12919	14688	12320	13791	15036	13427	15237	17161	
Gallery/Runoff WM 40w RH	...40R...	11358	12919	14688	12320	13791	15036	13427	15237	17161	
Gallery/Runoff WM 48w LH	...48L...	12327	13977	15812	13273	14847	16182	14178	15985	18040	
Gallery/Runoff WM 48w RH	...48R...	12327	13977	15812	13273	14847	16182	14178	15985	18040	
Gallery/Runoff WM 56w LH	...56L...	13273	15007	16906	14219	15869	17318	15229	17164	19243	
Gallery/Runoff WM 56w RH	...56R...	13273	15007	16906	14219	15869	17318	15229	17164	19243	
Gallery/Runoff WM 64w LH	...64L...	14238	16038	18051	15192	16926	18419	16329	18311	20519	
Gallery/Runoff WM 64w RH	...64R...	14238	16038	18051	15192	16926	18419	16329	18311	20519	
Gallery/Runoff WM 72w LH	...72L...	15237	17131	19207	16182	18021	19600	17093	19187	21440	
Gallery/Runoff WM 72w RH	...72R...	15237	17131	19207	16182	18021	19600	17093	19187	21440	
Gallery/Runoff WM 80w LH	...80L...	16182	18167	20322	17131	19009	20739	18167	20322	22640	
Gallery/Runoff WM 80w RH	...80R...	16182	18167	20322	17131	19009	20739	18167	20322	22640	
Gallery/Runoff WM 88w LH	...88L...	17065	19195	21463	18099	20066	21795	19222	21463	23917	
Gallery/Runoff WM 88w RH	...88R...	17065	19195	21463	18099	20066	21795	19222	21463	23917	
Gallery/Runoff WM 96w LH	...96L...	17929	20241	22559	19047	21118	22933	19963	22252	24787	
Gallery/Runoff WM 96w RH	...96R...	17929	20241	22559	19047	21118	22933	19963	22252	24787	

! Notes:

Determine product number by merging Prefix, Width and Matrix Codes; reference the price. Ex: PZG3WM40L1X1= \$11358.

Order Gallery Top separately and tag to your selection here.

+ Options/Parametrics:

Width range: 32-96; specify as Width Code and use next larger standard size for pricing.

Galleries for Bridges
Stainless Steel Wire Mesh
Captured Frame

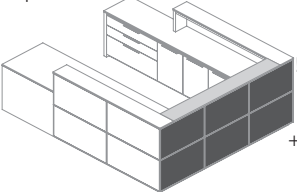

10.8d 43.8h	Prefix Code/Width Code:	Matrix Code:									
	PZG4WM...	...1x1	...1x2	...1x3	...2x1	...2x2	...2x3	...3x1	...3x2	...3x3	
Gallery/Bridge WM 96w (40)	...96...	-	-	-	17363	19200	20817	18282	20337	22675	
Gallery/Bridge WM 104w (48)	...104...	-	-	-	20549	22910	24809	21517	24049	26166	

! Notes:

Determine product number by merging Prefix, Width and Matrix Codes; reference the price. Ex: PZG2WM962X1= \$17363.
Order Gallery Top separately and tag to your selection here.

+ Options/Parametrics:

Width range: 92-104; specify as Width Code and use next larger standard size for pricing; bridge top must be 56-in less.

Specify: Product Number
Quantity
Color/Finish
Tagging

‡ Requires field sub-assembly.

Gallery Surround Panels
Gilded Cork
Captured Frame with Glass

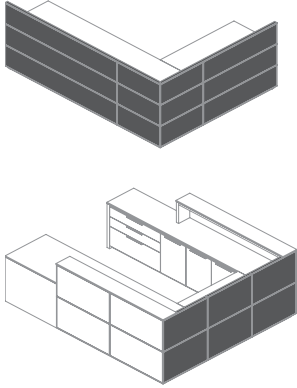

2d 43.8h	Prefix Code/Width Code:		Matrix Code:		
	PZG1GC...1x1	...1x2	...1x3
Gallery/Surround GC 21w	...21...	5515	7097	7862	
Gallery/Surround GC 24w	...24...	5874	7474	8274	
Gallery/Surround GC 28w	...28...	6252	7898	8736	
Gallery/Surround GC 32w	...32...	6600	8285	9158	
Gallery/Surround GC 36w	...36...	6960	8694	9610	
Gallery/Surround GC 40w	...40...	-	9042	10010	
Gallery/Surround GC 44w	...44...	-	9420	10412	
Gallery/Surround GC 48w	...48...	-	9787	10835	
Gallery/Surround GC 52w	...52...	-	10149	11237	
Gallery/Surround GC 56w	...56...	-	10625	11743	
Gallery/Surround GC 60w	...60...	-	11029	12198	
Gallery/Surround GC 64w	...64...	-	11401	12621	
Gallery/Surround GC 68w	...68...	-	11804	13040	
Gallery/Surround GC 72w	...72...	-	12198	13496	
Gallery/Surround GC 76w	...76...	-	12599	13953	
Gallery/Surround GC 80w	...80...	-	12979	14348	
Gallery/Surround GC 84w	...84...	-	13380	14792	
Gallery/Surround GC 88w	...88...	-	13749	15237	
Gallery/Surround GC 92w	...92...	-	14150	15636	
Gallery/Surround GC 96w	...96...	-	14553	16083	
Gallery/Surround GC 100w	...100...	-	-	16527	

! Notes:
 Determine product number by merging Prefix, Width and Matrix Codes; reference the price. Ex: PZG1GC211X1= \$5515.
 + Options/Parametrics:
 Width range: 8-100; specify as Width Code and use next larger standard size for pricing.

Captured frames
have a 0.19-in lip.



Innovations® Gilded Cork GCO-104 Cool Silver, captured with glass in an extruded MRBAS aluminum frame. Additional colors available; see [vendor's online site](#). COM materials may also be applied; contact Customer Service.

Specify: Product Number
Quantity
Color/Finish
Tagging

‡ Requires field sub-assembly.

Galleries for Desks & Credenzas
Gilded Cork
Captured Frame with Glass

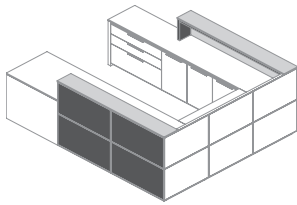

		Prefix Code/Width Code:		Matrix Code:								
10.8d	43.8h	PZG2GC...	...1x1	...1x2	...1x3	...2x1	...2x2	...2x3	...3x1	...3x2	...3x3	
Gallery/DeskCred GC 76w	...76...	---	-	16670	19268	15024	17135	19004	16082	18434	20993	
Gallery/DeskCred GC 80w	...80...	---	-	17050	19660	15373	17475	19399	16366	18738	21299	
Gallery/DeskCred GC 84w	...84...	---	-	17442	20095	15707	17868	19791	16629	19004	21670	
Gallery/DeskCred GC 88w	...88...	---	-	17851	20579	16103	18303	20271	17155	19615	22282	
Gallery/DeskCred GC 92w	...92...	---	-	18247	20973	16442	18698	20707	17415	19921	22655	
Gallery/DeskCred GC 96w	...96...	---	-	18631	21414	16795	19070	21152	17705	20235	22969	
Gallery/DeskCred GC 100w	...100...	---	-	21853	17117	19464	21591	18144	20762	23535		
Gallery/DeskCred GC 104w	...104...	---	-	17538	19975	22246	18583	21284	23645			
Gallery/DeskCred GC 108w	...108...	---	-	17889	20456	22640	18843	21591	24018			
Gallery/DeskCred GC 112w	...112...	---	-	18265	20805	23078	19368	22200	24630			
Gallery/DeskCred GC 116w	...116...	---	-	18625	21205	23524	19660	22474	24944			
Gallery/DeskCred GC 120w	...120...	---	-	19004	21639	24000	19943	22821	25356			
Gallery/DeskCred GC 124w	...124...	---	-	19338	22003	24441	20449	23389	25927			

- ! Notes:
Determine product number by merging Prefix, Width and Matrix Codes; reference the price. Ex: PZG2GC761X2= \$16670.
Order Gallery Top separately and tag to your selection here.
Designate placement of Gallery on Desk or Credenza as user's Left, Center or Right.
- + Options/Parametrics:
Width range: 60-124; specify as Width Code and use next larger standard size for pricing.

Galleries for Runoffs
Gilded Cork
Captured Frame with Glass

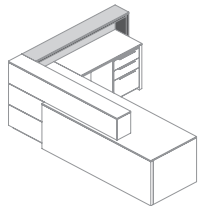

		Prefix Code/Width Code:		Matrix Code:								
10.8d	43.8h	PZG3GC...	...1x1	...1x2	...1x3	...2x1	...2x2	...2x3	...3x1	...3x2	...3x3	
Gallery/Runoff GC 40w LH	...40L...	---	-	11211	13004	10607	12103	13355	11663	13446	15391	
Gallery/Runoff GC 40w RH	...40R...	---	-	11211	13004	10607	12103	13355	11663	13446	15391	
Gallery/Runoff GC 48w LH	...48L...	---	-	11993	13843	11301	12867	14238	12216	14016	16073	
Gallery/Runoff GC 48w RH	...48R...	---	-	11993	13843	11301	12867	14238	12216	14016	16073	
Gallery/Runoff GC 56w LH	...56L...	---	-	12750	14697	11988	13626	15069	12960	14891	17013	
Gallery/Runoff GC 56w RH	...56R...	---	-	12750	14697	11988	13626	15069	12960	14891	17013	
Gallery/Runoff GC 64w LH	...64L...	---	-	13518	15558	12677	14390	15904	13735	15734	17960	
Gallery/Runoff GC 64w RH	...64R...	---	-	13518	15558	12677	14390	15904	13735	15734	17960	
Gallery/Runoff GC 72w LH	...72L...	---	-	14330	16429	13407	15220	16825	14324	16385	18684	
Gallery/Runoff GC 72w RH	...72R...	---	-	14330	16429	13407	15220	16825	14324	16385	18684	
Gallery/Runoff GC 80w LH	...80L...	---	-	15091	17281	14076	15950	17656	15069	17217	19557	
Gallery/Runoff GC 80w RH	...80R...	---	-	15091	17281	14076	15950	17656	15069	17217	19557	
Gallery/Runoff GC 88w LH	...88L...	---	-	15856	18144	14769	16743	18493	15817	18056	20504	
Gallery/Runoff GC 88w RH	...88R...	---	-	15856	18144	14769	16743	18493	15817	18056	20504	
Gallery/Runoff GC 96w LH	...96L...	---	-	16644	18976	15455	17502	19368	16366	18667	21182	
Gallery/Runoff GC 96w RH	...96R...	---	-	16644	18976	15455	17502	19368	16366	18667	21182	

- ! Notes:
Determine product number by merging Prefix, Width and Matrix Codes; reference the price. Ex: PZG3GC40L1X2= \$11211.
Order Gallery Top separately and tag to your selection here.
- + Options/Parametrics:
Width range: 32-96; specify as Width Code and use next larger standard size for pricing.

Galleries for Bridges
Gilded Cork
Captured Frame with Glass

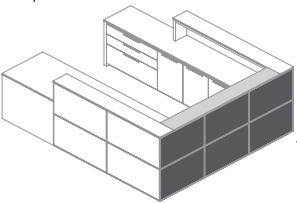

		Prefix Code/Width Code:		Matrix Code:								
10.8d	43.8h	PZG4GC...	...1x1	...1x2	...1x3	...2x1	...2x2	...2x3	...3x1	...3x2	...3x3	
Gallery/Bridge GC 96w (40)	...96...	---	-	14654	16533	14114	15936	17582	15026	17102	19399	
Gallery/Bridge GC 104w (48)	...104...	---	-	16551	18888	20855	17502	20024	22233			

- ! Notes:
Determine product number by merging Prefix, Width and Matrix Codes; reference the price. Ex: PZG4GC961X2= \$14654.
Order Gallery Top separately and tag to your selection here.
- + Options/Parametrics:
Width range: 92-104; specify as Width Code and use next larger standard size for pricing; bridge top must be 56-in less.

Specify: Product Number ‡ Requires field sub-assembly.
Quantity
Color/Finish
Tagging

